



**OPERATOR'S / PARTS
MANUAL**



Snowblowers
Model

PGS-740

&

PGS-800



Copyright © Les Machineries Pronovost Inc., 2011

All rights reserved.
Printed in Canada.

TABLE OF CONTENTS

Section	Item	Page
1	Introduction	5
2	Safety	6
	General Safety	6
	Safety in Operation	6
	Safety with Maintenance	7
	Safety in Transport	7
	Safety in Storage	7
3	Decals	8
	Safety Decals	8
	Maintenance Decals	12
4	Assembly	13
	General assembly	13
	Hydraulic Chute Kit: Motor	14
5	Start-up	15
	Basic Start-up Procedures	15
6	Maintenance	16
	General maintenance	16
7	Storage	17
8	Trouble Shooting	18
9	Specifications	20
10	Parts List	21
	Snowblower PGS-740 PGS-800	21
	Hydraulic chute rotation kit for motor	24
	Semi-industrial Chute PSIG-5472	26
	P.T.O. Shaft T60 # 8202	27
	Gear Box # 8251	28
	Cylinder 25TR04	29
	Hydraulic Motor MLH-250	30
11	Torque Chart	31
12	Warranty	32

INTRODUCTION

CONGRATULATIONS!

Thank you for choosing PRONOVOST. We are confident this equipment will meet your requirements in terms of quality, performance and reliability.

This manual was prepared to assist you in the safe operation of your new Snowblower. It contains important information which will help you achieve excellent returns with your Snowblower for years to come.

Please read this manual completely before operating your Snowblower and keep it for future reference.

Before starting the machine, you or any other person who will be operating the Snowblower must familiarize yourself with the safety recommendations and the operating instructions. Please read carefully and be sure to understand and follow all recommendations and procedures.

In this manual, the right and left sides are identified as shown on Figure 1.

If you require additional information on your Snowblower, please contact your PRONOVOST Dealer.

NOW take a moment to enter the model, serial number and the date of purchase of your Snowblower in the space provided.

When ordering parts from your Dealer, please refer to these numbers for a fast and efficient service. Use PRONOVOST parts for replacement.

The model and serial numbers are on the name plate shown on Fig. 1.

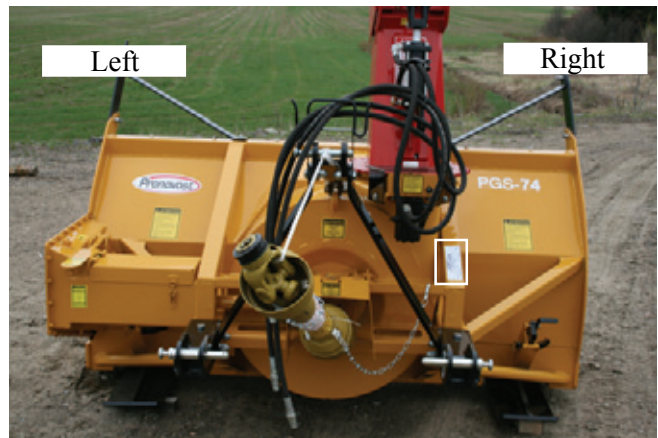

Figure 1

MODEL: _____ ✍

SERIAL NO: _____ ✍

DATE OF PURCHASE: _____ ✍

SAFETY

GENERAL SAFETY

2

WHEN YOU SEE THIS SYMBOL



ATTENTION!

**BE ALERT
YOUR SAFETY IS INVOLVED**

This symbol «**SAFETY ALERT**» is used in this manual and on the safety decals on the Snowblower. It warns you of the possibility of danger. Carefully read, understand and follow all safety recommendations before operating the Snowblower.

- 1) Careful operation is the best assurance against accidents. Carefully read this manual and follow all recommendations before operating your Snowblower. It is the owner's responsibility to make sure that anyone who will operate the Snowblower will read this manual before operating the equipment.
- 2) Familiarize yourself with all controls and always be ready to stop the Snowblower quickly in case of emergency.
- 3) Never let a child operate the Snowblower.
- 4) Do not modify the Snowblower. Any non authorized modification may affect the efficiency and/or safety of the equipment and will automatically void the warranty.
- 5) Never operate the Snowblower with defective parts or if damaged in any way. Have it repaired before operating.
- 6) Make sure all fasteners are in place and properly secured or tightened. Refer to torque chart on page 31.
- 7) Avoid wearing loose fitting clothing when working with the Snowblower. These could get entangled in moving parts of the equipment and cause accidents.

- 8) Prolonged exposure to noise may hamper hearing. Protect yourself by wearing adequate protection devices.
- 9) Hydraulic fluids under pressure can damage your skin. Do not use your hands to locate a leak.
- 10) Before the beginning of the snow season, inspect all areas where the Snowblower will be used and remove any object which may cause an accident and/or damage the equipment.
- 11) Never operate your Snowblower in poor visibility or without proper lighting conditions.

SAFETY IN OPERATION

- 1) Be sure there are no obstructions around the equipment and that no one stands near the equipment when in operation.
- 2) Do not operate an engine in a confined or non ventilated area.
- 3) Do not perform any adjustments, cleaning, maintenance or repairs with the engine running. The engine must be stopped and the P.T.O. disengaged. Preferably remove the key from the ignition.
- 4) Wear adequate clothing when working in cold or windy conditions.
- 5) Adjust skid shoes for proper ground clearance of scraper blade, especially in rough terrain or soft ground conditions.
- 6) Before operating, make sure the P.T.O. is properly installed and secured.
- 7) Before starting-up the Snowblower, make sure the auger and drum areas are free of ice.
- 8) Put P.T.O. control in neutral position before starting engine.
- 9) Keep hands, feet and clothing away from moving parts of the Snowblower. Stay away from the discharge chute.

SAFETY (cont'd)

- 10) Before unplugging the chute, always disengage the P.T.O., stop the engine and relieve all hydraulic pressure.
- 11) Do not operate in excessive inclined conditions. Be careful when turning on slopes.
- 12) Never operate your Snowblower with missing guards or without protective devices in place.
- 13) Do not operate your Snowblower near buildings, windows or other vehicles without prior and proper adjustment of the chute deflector.
- 14) Never aim discharge chute towards people or animals. This may cause serious injuries.
- 15) Always reduce operating speed in slippery conditions.
- 16) Be careful when backing-up, make sure you have good visibility.
- 17) Always be on the lookout for objects which may enter the snowblower.
- 18) If undue vibrations are felt, disengage the P.T.O., stop the motor and look for the cause of the vibration. Vibration is usually the indication of a problem.
- 19) At the end of the operation, disengage the P.T.O., lower the Snowblower, put transmission in neutral, apply parking brake, stop engine and remove the key from the ignition.

SAFETY WITH MAINTENANCE

- 1) Perform the Snowblower maintenance according to recommendations contained in this manual.

- 2) Stop engine and relieve all hydraulic pressures before doing inspection, maintenance or repairs.
- 3) Never perform any work under the Snowblower while it is supported only by the tractor's hydraulic system. It must be completely supported on blocks with sufficient capacity.

SAFETY IN TRANSPORT

- 1) On public roads, use proper safety lights and check local regulations.
- 2) Be alert while driving on the road. Never carry passengers.
- 3) Always disengage P.T.O. while moving from one area of work to another.
- 4) It is recommended to use both brake pedals simultaneously for better control.
- 5) The recommended road speed should be such as to maintain full control over steering and braking.
- 6) Be careful while backing up, make sure you have good visibility.

SAFETY IN STORAGE

- 1) Provide adequate supports to prevent any accidental overturning of the Snowblower.
- 2) Do not let children play in the area where the Snowblower is stored.

2

DECALS

SAFETY DECALS

The safety decals are affixed wherever special safety precautions are indicated. Locate them on the machine and read them carefully. If a decal is damaged, lost or illegible, install a new one. The following photos indicate where each one must be installed.

3

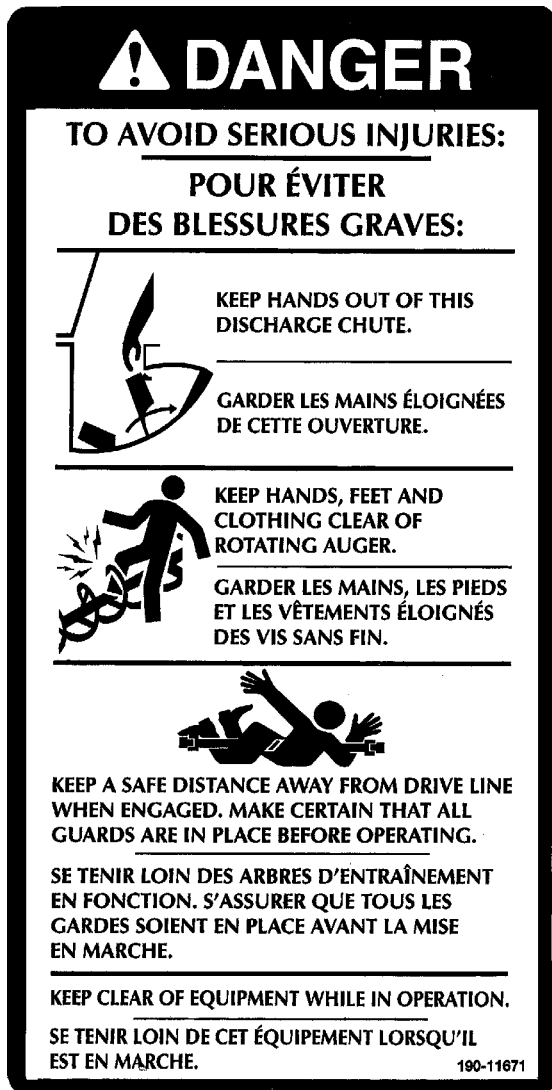

Figure 2
Decal A

Part no.: 190-11671



Figure 3

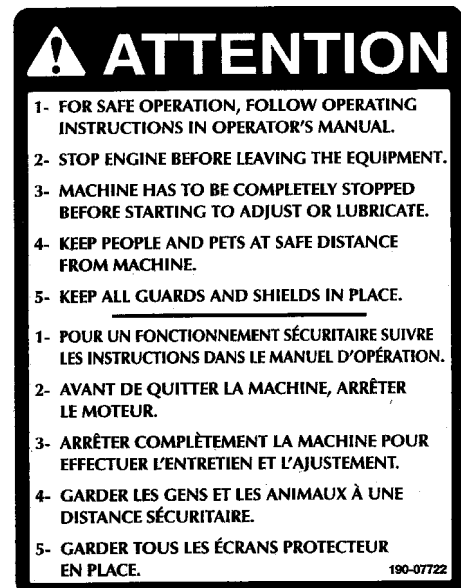

Figure 4
Decal B

Part no.: 190-07722

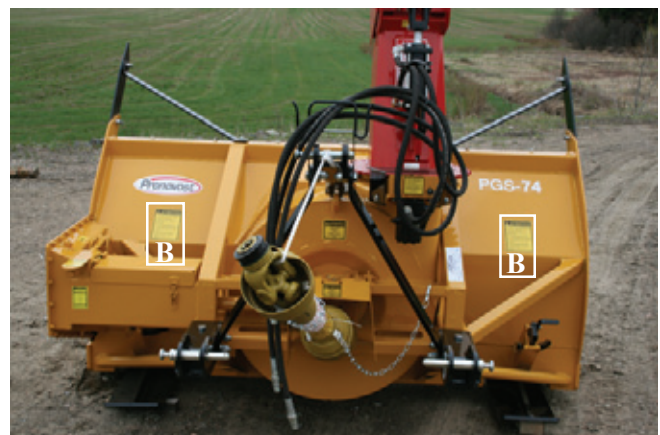

Figure 5

DECALS (cont'd)



Figure 6

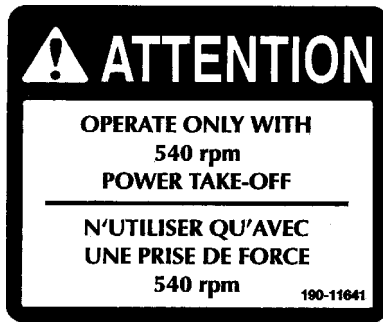

Figure 7
Decal C

Part no.: 190-11641

Decal E in Fig. 8 is located directly on the P.T.O. shaft. It is not visible when the safety shield is in place. It must never be visible when you operate the equipment.



Figure 8
Decal E

Part no.: A108

3

DECALS (cont'd)

3



190.000.215

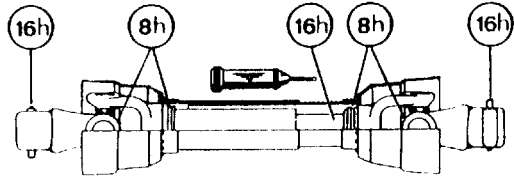

Figure 9
Decal F

Part no.: A 109



Figure 10



Figure 11
Decal D

Part no.: A103



Figure 12



Figure 13
Decal G

Part no.: 190-10991

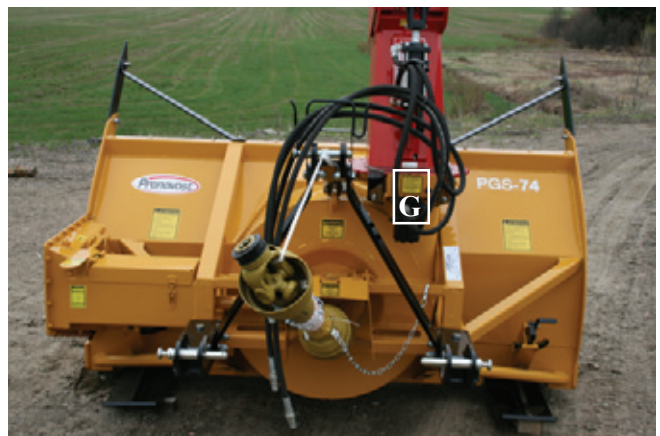

Figure 14

DECALS (cont'd)

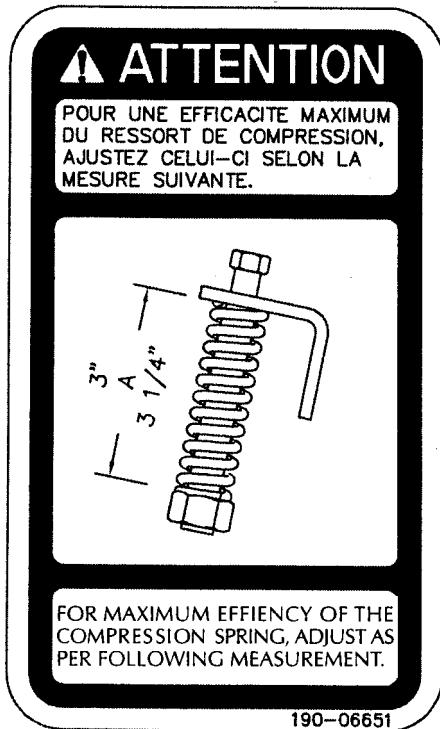

Figure 15
Decal H

Part no.: 190-06651



Figure 16

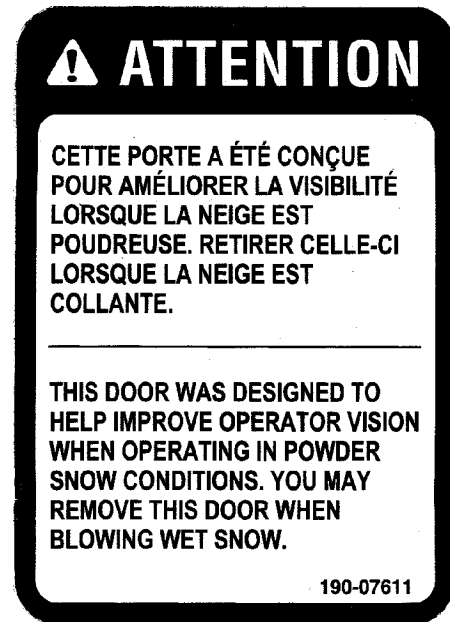

Figure 17
Decal J

Part no.: 190-07611



Figure 18

DECALS (cont'd)

MAINTENANCE DECALS

The maintenance decals indicate the points requiring lubrication. Refer to maintenance section for more details.

3



A 105

Figure 19



A 106



Figure 21



Figure 20
Decal L

Part no.: 190-11581



Figure 22

ASSEMBLY



Figure 23

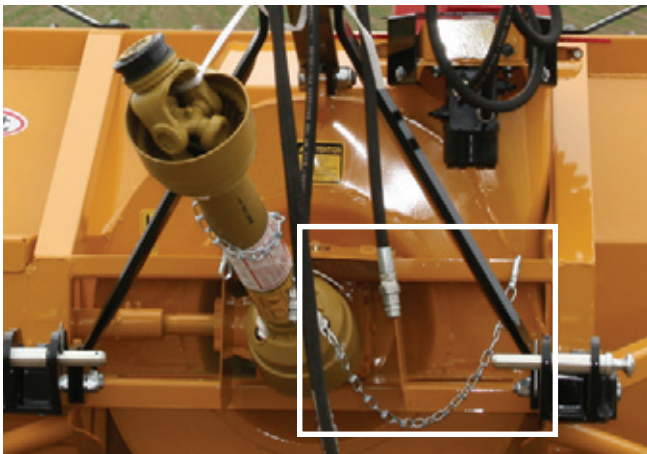

Figure 24

ASSEMBLY

- 1) The Snowblower is shipped partly assembled.
- 2) Install 3-point system according to the model of your Snowblower. (See section 10 for part numbers). Use the holes most convenient to the type of tractor used (Fig. 23).
- 3) Install P.T.O. shaft with the shear pin end onto the Snowblower gear box. Then attach both safety shield support chains to tractor and snowblower (Fig. 24). **WARNING:** The telescoping tubes of the drive shaft must never be allowed to bottom out while maintaining a minimum overlap of 6 inches.
- 4) For the installation of the chute rotation mechanism, please refer to page 14.

4

ASSEMBLY (cont'd)

4



Figure 25

HYDRAULIC CHUTE ROTATION Motor

- 1) Install U-shaped UHMW piece, place chute on Snowblower and secure with retaining bracket and bolts provided.
- 2) Install the mounting plate; put the required spacers between mounting plate and base of chute (see p. 24 & 25). Do not tighten the bolts immediately, they will be tightened at final adjustment (Fig. 25).
- 3) Install motor and 9 tooth gear. The thickness of the 9 tooth gear is slightly more than the ring-gear. Make sure it exceeds on both sides of the ring gear (Fig. 26).
- 4) Using the take-up screws, adjust gear to mesh without bottoming. Tighten mounting plate bolts.
- 5) Install guard. It is important that the cushion valve furnished with your chute rotation kit be installed. Cushion valve has been pre set in plant at 1200 psi. (Fig. 27).



Figure 326



Figure 27

STARTING-UP



Figure 28



Figure 29



Figure 30

START-UP PROCEDURES

- 1) **Check** oil level in **gearbox** and in speed reducer if so equipped. Use **SAE 80W90** gear box oil.
- 2) **Check** oil level in **auger drive chain box**. Fill to level plug. Use **SAE 80W90** oil (Fig. 28).
- 3) Lubricate all points with a good quality multipurpose grease. For the PTO tubes, use a grade 0 synthetic grease like "Petro-Canada Arctic Synthetic NLGI Grade 0" or equivalent.
- 4) Check chain take-up adjustment. The spring maintaining the tension must be compressed to a length between 3" and 3 1/4".
- 5) Verify for adequate tightness of all fastening devices. Refer to torque chart on page 31.
- 6) Adjust skid shoes according to ground conditions (Fig. 29).
- 7) Make sure of a 540 RPM input to your snowblower.
- 8) Check impeller adjustment. The tip of the blades should be approximately 1/8" to 3/16" from the discharge wall of the drum. If necessary, adjust with the take-up screws provided (Fig. 30).

MAINTENANCE

GENERAL MAINTENANCE

- 1) Wipe off all grease fittings with a clean cloth before adding grease in order to avoid injecting dirt and sand.
- 2) Repair or replace damaged grease fittings.
- 3) Lubricate all grease fittings every 8 hours of operation.
- 4) Lubricate P.T.O. shaft as indicated below:
- 7) Check tension of drive chain every 24 hours of operation and adjust if necessary.
- 8) Check for tightness of bearing collars every 48 hours of operation.
- 9) **Change gearbox** oil once a year. Adjust to required oil level as per drawing in "Parts List section". Use **SAE 80W90** oil.

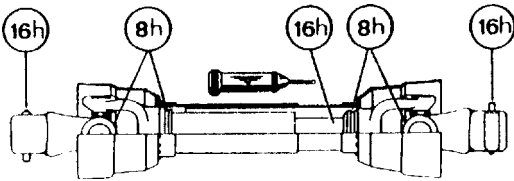

Pull out the P.T.O. And lubricate between the two tubes with low temperature grease. Use a grade 0 synthetic grease like "Petro-Canada Arctic Synthetic NLGI Grade 0" or equivalent. Drive line tubes must slide easily even in cold weather. Clean off old hardened grease and apply fresh grease as needed.

- 5) **Check** oil level in **gear box** once a month. Adjust to required oil level as per drawing in "Parts List section". Use **SAE 80W90** oil.
- 6) **Check** oil level in **auger drive chain box** once a month. Fill to level plug, figure 28 page 15. Use **SAE 80W90** oil.
- 10) **Change the auger drive chain box** oil once a year. Fill to level plug, figure 28 page 15. Use **SAE 80W90** oil.
- 11) Check all nuts and bolts once a year. If necessary use torque chart on page 31.
- 12) For the auger drive shaft, always use a grade 5 shear bolt.
- 13) For the PTO shaft:
AT 540 RPM on a PTO size 60, the shear bolt is 10 mm, grade 8.8, part number **8218**.
- 14) Anti-friction slides do not require lubrication except at the end of the season in order to prevent corrosion of steel components that are in contact with the anti-friction material.

STORAGE

- 1) Store the Snowblower in a cool, dry place.
- 2) Support the Snowblower with wooden blocks.
- 3) Keep all piston rods in the retracted position. This will assure better protection against the elements.
- 4) Clean your Snowblower.
- 5) Thoroughly inspect all parts of the Snowblower. Replace or repair worn or defective parts.
- 6) Touch-up or repaint if necessary.
- 7) Lubricate all points before storage.

TROUBLESHOOTING

P.T.O. SHAFT

PROBLEM	POSSIBLE CAUSE	CORRECTION
- Premature wear of U-joints and/or bluish color of cross journals.	- Insufficient lubrication. - Excessive working angle. - Poor quality lubricant.	- Follow lubrication recommendations. - Replace defective U-joints. - Make sure the Snowblower inlet face is perpendicular to the ground and if possible readjust 3-point hitch in order to position the Snowblower further away from tractor. - Use high quality lubricant.
- Gripping or premature wear of telescoping members.	- Too much sliding under load. - Tube overlap too-short: minimum recommended is 6". - Insufficient lubrication. - Contaminants (sand, etc.).	- Avoid raising Snowblower while in operation. - Readjust 3-point hitch in order to position the Snowblower closer to the tractor. - Follow lubrication recommendations. - Replace defective telescopic members.
- Damaged or jammed locking pin or bolt.	- Pin or orifice contaminated by sand, ice, etc. - Telescoping members too long, exerting pressure on locking device.	- Clean and grease. - Readjust 3-point hitch in order to position the Snowblower further away from tractor or shorten tubes.
- Premature wear of guard tube bearing ring.	- Lack of lubrication. - Wrong installation of guard chain. - Part of the guard in contact with the equipment.	- Follow lubrication instructions. - Adjust chain to prevent interference between guard & equipment. - Replace worn or damaged bearing rings.
- Cut or deformed safety guard tubes.	- Tubes in contact with the equipment.	- Eliminate any interference between tubes and equipment or tractor. - Replace damaged tubes.

TROUBLESHOOTING (cont'd)

SNOWBLOWER

PROBLEM	POSSIBLE CAUSE	CORRECTION
- The snow is not being thrown as far as usual.	<ul style="list-style-type: none"> - Tractor RPM too low. - Gap too wide between impeller blade tip and drum outlet wall. - Insufficient tractor HP. 	<ul style="list-style-type: none"> - Raise P.T.O. speed to a minimum of 540 RPM. - Adjust impeller blades closer to drum outlet (1/8" to 3/16"). - Reduce travel speed.
- Frequent plugging of discharge chute.	<ul style="list-style-type: none"> - Tractor RPM too low. - Tractor RPM reduced too early with snow still in the Snowblower. - Slippage of PTO clutch mechanism. - Wet snow condition. 	<ul style="list-style-type: none"> - Raise P.T.O. speed to a minimum of 540 RPM. - Make sure the Snowblower is completely empty before reducing RPM, especially on tractors with foot controlled RPM. - Repare clutch. - Reduce travel speed. - Remove the chute access panel.
- The impeller will not turn.	<ul style="list-style-type: none"> - Shear bolt broken on drive shaft. 	<ul style="list-style-type: none"> - Replace shear bolt.
- The auger will not turn.	<ul style="list-style-type: none"> - Shear bolt broken on drive shaft. - Shear bolt broken on auger drive shaft. - Broken drive chain. - Broken key on motor. 	<ul style="list-style-type: none"> - Replace shear bolt. - Replace shear bolt. - Fix or replace chain. - Replace the key.
- The chute will not turn.	<ul style="list-style-type: none"> - Ice accumulation. - Wrong hydraulic connections. - Broken key on motor. 	<ul style="list-style-type: none"> - Remove ice. - Check hydraulic connections. - Replace the key.

SPECIFICATIONS

Model	PGS-740	PGS-800
Horse power required	35 to 65 HP	
Approximate performance	500 tons imp./hour (tractor 60 HP)	
Height - chute base	35"	
Chute rotation	On anti-friction ring, for hydraulic motor	
Frame height	36 3/4"	
Lateral cutting height	58 1/2"	
Working width	74"	80"
Drum diameter	28"	
Depth of drum	10 1/2"	
Drum position	Centered	
Drum liner	3/16" carbon steel 450	
Impeller blades	4 blades x 3/8" thickness - welded	
Size and height of impeller shaft	Diameter 1.575" (40 mm) - Height 18"	
Impeller speed	540 RPM (CW)	
Standard P.T.O. shaft	T60	
Auger	Dual band, toothed, welded, 28" diameter	
Drive chain	RENOLD No. 80HV in oil bath	
Shear bolt	1 for the impeller + 1 for the auger drive	
Scraper	Carbon steel	Standard
blade	Stainless steel	Optional
Skid	Carbon steel (quick adjust)	Standard (2 patins)
shoes	Stainless steel (quick adjust)	Optional (2 patins)
	Rocktec (quick adjust)	Optional (2 patins)
Bearing / ductile iron casing	Standard	
3-point hitch	Category 2	
Center of gravity from 3-pt hitch at its shortest	30 1/2"	
Rotational force (reference)	42 468 lbs-po	44 580 lbs-po
Weight*	1 475 lbs	1 526 lbs

Design and specifications subject to change without notice.

* Weight including chute, cylinder for chute deflector and hydraulic motor for chute rotation.

SNOWBLOWER PGS-740 PGS-800

170-05873

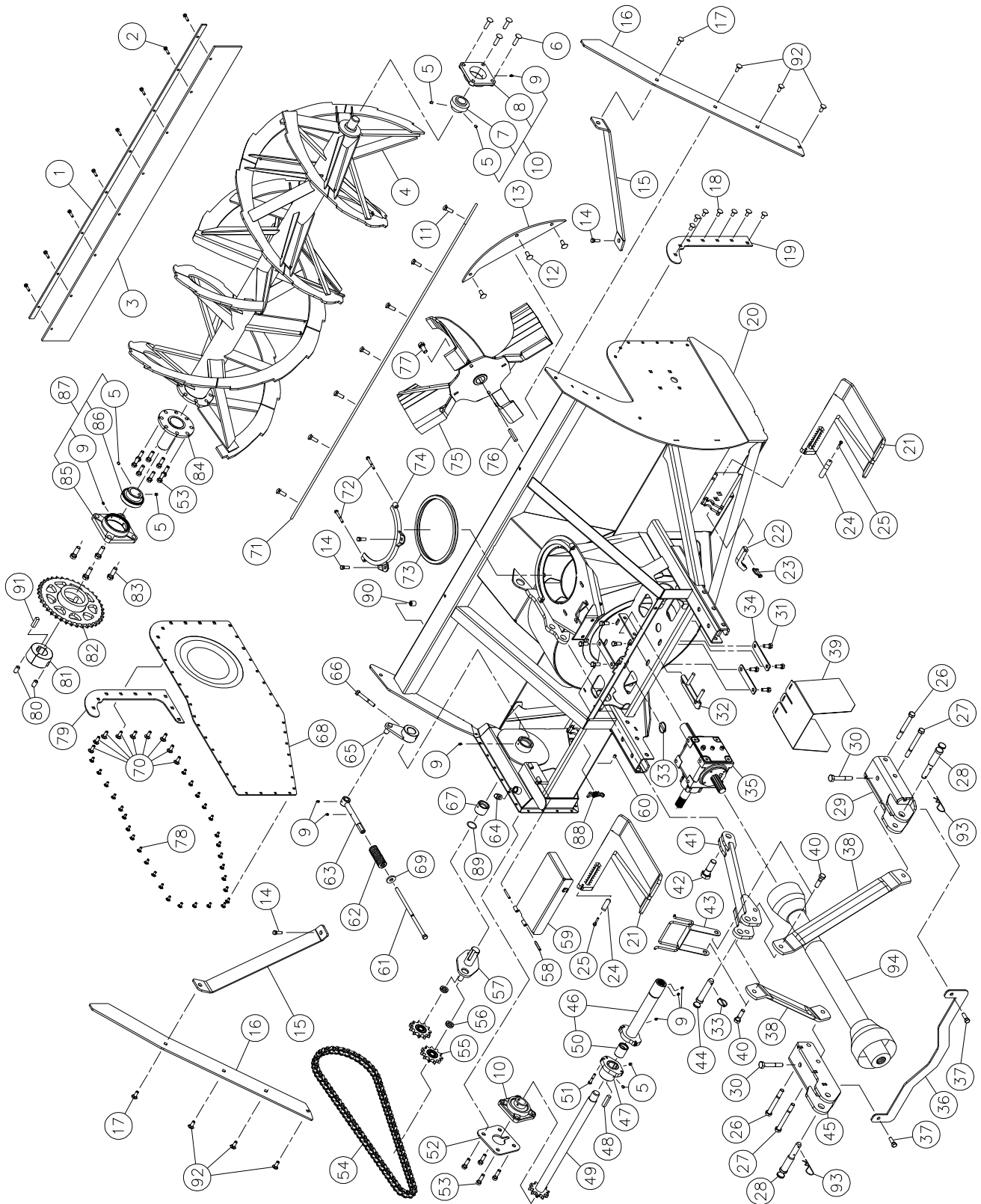

SNOWBLOWER PGS-740 PGS-800 (cont'd)

REF.	PART #	DESCRIPTION	QTY	
			PGS-740	PGS-800
1	140-26831	Back plate for the shroud	1	-
1	140-26971	Back plate for the shroud	-	1
2	300-34280	Bolt 5/16" NC x 1 1/4" lg + nylon locknut	8	9
3	190-13861	Shroud	1	-
3	190-13891	Shroud	-	1
4	110-46982	Auger for PGS-740	1	-
4	110-49041	Auger for PGS-800	-	1
5	323-36160	Hexagonal socket set screw 3/8" NC X 3/8" lg	8	8
6	321-40340	Carriage bolt 1/2" NC x 2" lg + spring washer + nut	4	4
7	UC-208-24	Bearing 1 1/2"	2	2
8	FD208	Flange 4 holes	2	2
9	Std.	Grease fitting 1/4"-28 straight	12	12
10	UCFD208-24	Bearing 1 1/2" + flange & 2 grease fitting straight	2	2
11	321-40310	Carriage bolt 1/2" NC x 1 1/2" lg + nylon locknut	7	8
12	321-40280	Carriage bolt 1/2" NC x 1 1/4" lg + nylon locknut	3	3
13	130-92231	Deflector	1	1
14	300-38280	Bolt 7/16" NC x 1 1/4" lg + rondelle + nylon locknut	4	4
15	130-90673	Lateral blade strengthener	2	2
16	130-94521	Lateral blade	2	2
17	321-38280	Carriage bolt 7/16" NC x 1 1/4" lg + 2 flat washer + 2 nylon locknut	2	2
18	321-38250	Carriage bolt 7/16" NC x 1" lg + spring washer + nut	7	7
19	130-90511	Right lateral brace	1	1
20	120-08102	Frame PGS-740	1	-
20	120-08332	Frame PGS-800	-	1
21	110-47951	Skid shoe	2	2
22	130-90531	Skid shoes lock	2	2
23	8112	Lock pin 1/4"	2	2
24	140-26661	Handle for skid shoe	2	2
25	300-32310	Bolt 1/4" NC x 1 1/2" lg + nylon locknut	2	2
26	300-44550	Bolt 5/8" NC x 5 1/2" lg + nylon locknut	2	2
27	300-44580	Bolt 5/8" NC x 6" lg + nylon locknut	2	2
28	8004	Pin category 1 & 2	2	2
29	110-47651	Right lower hitch	1	1
30	300-44460	Bolt 5/8" NC x 4" lg + nylon locknut	2	2
31	300-40280	Bolt 1/2" NC x 1 1/4" lg + lock washer + nut	8	8
32	110-47061	Adjustment plate for gear box + 4 nut 1/2" - NC	1	1
33	Std.	Lynch pin 1/4"	2	2
34	130-90591	Back plate	3	3
35	8251	Gear box T-27D	1	1
36	130-97051	Brace	1	1
37	300-40310	Bolt 1/2" NC x 1 1/2" lg + nylon locknut	2	2
38	140-26651	3-points side bar	2	2
39	130-90941	P.T.O. shroud	1	1
40	300-44355	Bolt 5/8" NC x 2 1/4" lg + nylon locknut	2	2
41	110-47931	Top link	1	1
42	300-50400	Bolt 1" NC x 3" lg + nylon locknut	1	1
43	110-15291	Hoses support	1	1
44	150-05961	Pin category 2 for top link	1	1
45	110-47641	Left lower hitch	1	1
46	110-47123	Side shaft & shearplate (long side) + splined adaptor (20 splines)	1	1
47	110-47103	Side shaft & shearplate (short side)	1	1

SNOWBLOWER PGS-740 PGS-800 (cont'd)

REF.	PART #	DESCRIPTION	QTY	
			PGS-740	PGS-800
48	140-26321	Key 1/2" x 1/2" x 2 3/8"	1	1
49	110-47111	Auger drive shaft for PGS-740	1	-
49	110-49091	Auger drive shaft for PGS-800	-	1
50	160-27622	Aluminium-bronze bushing 1 1/2" i.d. x 1 3/4" o.d. x 2" lg	1	1
51	300-34340	Bolt 5/16" NC x 2" lg + nylon locknut	1	1
52	130-88491	Adjustment plate for auger drive shaft	1	1
53	300-40250	Bolt 1/2" NC x 1 3/4" lg + nylon locknut	4	4
54	190-13441	Drive chain RENOLD HV # 80	1	1
55	9287	Idler sprocket #80	2	2
56	160-27771	Spacer	2	2
57	110-47231	Idler + nylon locknut 3/4" (thin)	1	1
58	Std.	Spring pin 5/16" x 2" lg	2	2
59	110-47921	Auger drive shaft guard PGS-740	1	-
59	110-49071	Auger drive shaft guard PGS-800	-	1
60	3169-02	Oil level plug 1/8" NPTF	1	1
61	110-47961	Threaded rod for idler adjustment	1	1
62	9688	Compression spring	1	1
63	110-47941	Threaded tube for idler adjustment	1	1
64	Std.	Breather 1/2"	1	1
65	110-47261	Idler	1	1
66	300-40430	Bolt 1/2" NC x 3 1/2" lg + nylon locknut	1	1
67	160-27711	Idler bushing	1	1
68	130-90502	Oil bath cover	1	1
69	376-40000	Flat washer 1/2"	1	1
70	321-38281	Carriage bolt 7/16" NC x 1 1/4" lg + spring washer + nut	9	9
71	140-26272	Scraper blade PGS-740	1	-
71	140-26911	Scraper blade PGS-800	-	1
72	300-34370	Bolt 5/16" NC x 2 1/2" lg + nylon locknut	2	2
73	190-02132	Anti-friction ring	1	1
74	110-02001	Retaining bracket	1	1
75	110-47972	Impeller 28" x 9"	1	1
76	8030	Key 3/8" x 3/8" x 3 1/2" lg	1	1
77	300-44310	Bolt 5/8" NC x 1 1/2" lg + lock washer	1	1
78	321-34220	Carriage bolt 5/16" NC x 3/4" lg + lock washer + nut	29	29
79	130-96261	Left lateral brace	1	1
80	323-44280	Hexagonal socket set screw 5/8" NC x 1 1/4" lg	2	2
81	3030X2	Male adaptor «taper-lock»	1	1
82	110-47031	Sprocket for auger 80A37 + female adaptor «taper-lock»	1	1
83	300-44340	Bolt 5/8" NC x 2" lg + nylon locknut	4	4
84	110-47011	Auger hub (auger drive end)	1	1
85	FD211	Cast iron flange 4 holes	1	1
86	UC211-32	Bearing 1"	1	1
87	UCFD211-32	Bearing 1" + cast iron flange & grease fitting	1	1
88	8374	Adjustable clamp fastener (welded)	1	1
89	O-222	O-ring 1/8" x 1 1/2" d.i. x 1 3/4" d.e.	1	1
90	2653	Magnetic plug 1/2 NPT	1	1
91	140-27411	Key 1/2" x 1/2" x 1 3/4" lg	1	1
92	321-38280	Carriage bolt 7/16" NC x 1 1/4" lg + nylon locknut	6	6
93	Std.	Hitch pin clip 5/32"	2	2
94	8202	P.T.O. shaft	1	1

HYDRAULIC CHUTE ROTATION KIT SP-7480-PGS

170-06271

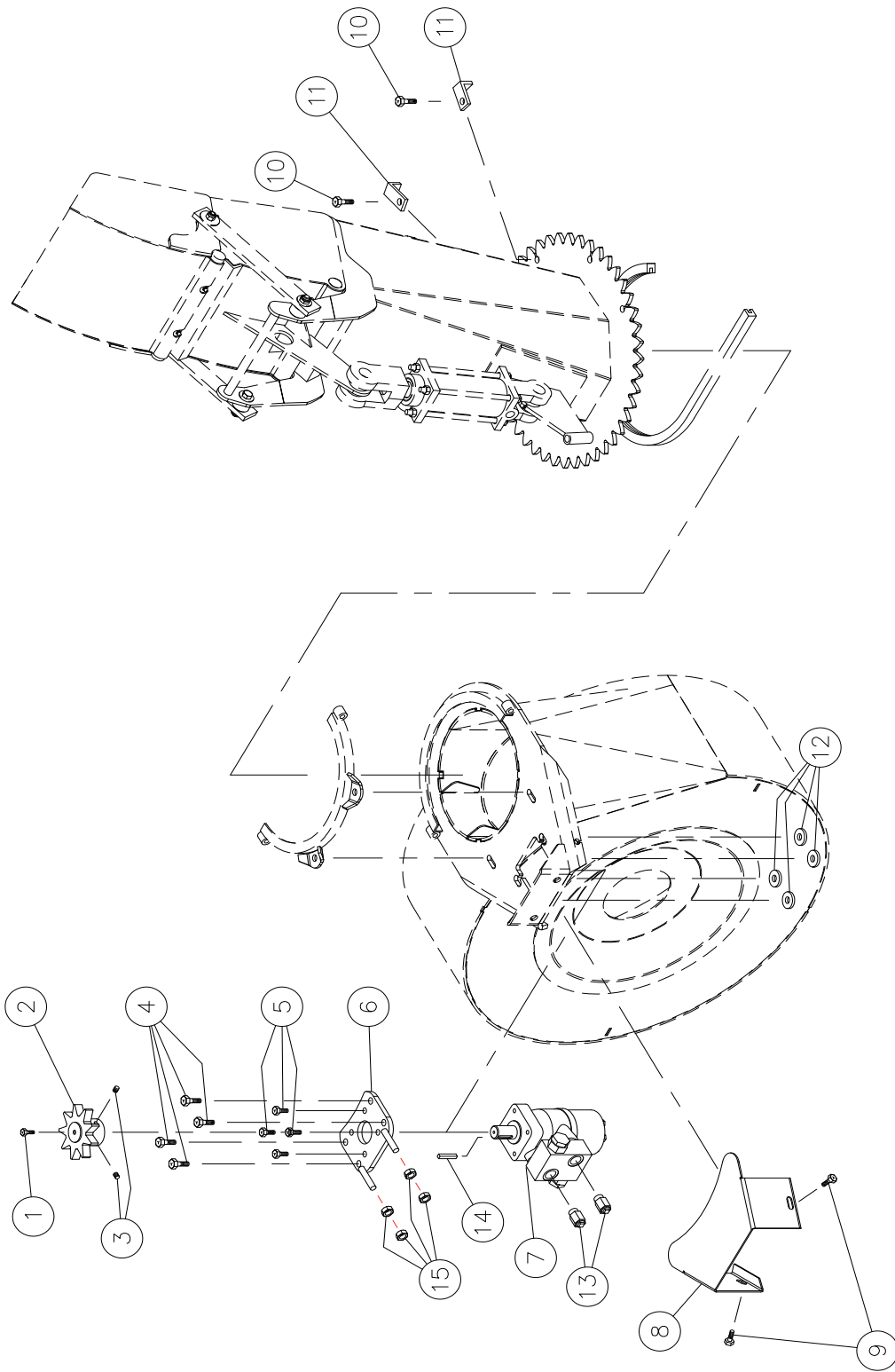

10

HYDRAULIC CHUTE ROTATION KIT SP-7480-PGS (cont'd)

REF.	PART #	DESCRIPTION	QTY
1	300-32220	Bolt 1/4" NC x 3/4" lg + lock washer	1
2	110-44331	Sprocket 9 teeth	1
3	323-36160	Hexagonal socket setscrew 3/8" NC x 3/8" lg	2
4	300-38280	Bolt 7/16" NC x 1 1/4" lg + nylon locknut	4
5	300-36250	Bolt 3/8" NC x 1" lg + lock washer	4
6	110-20811	Hydraulic motor support	1
7	MLH-250	Hydraulic motor with cushion valve	1
8	130-08162	Hydraulic motor guard	1
9	300-34250	Bolt 5/16" NC x 1" lg + lock washer	2
10	300-38280	Bolt 7/16" NC x 1 1/4" lg + nylon locknut	2
11	140-05661	Stopper	2
12	150-12741	Flat washer 7/16" heavy duty	4
13	RSP-1/16x100RB	Kit of two unidirectional restrictors	opt.
14	8369	Key	1
15	336-38000	Nut 7/16" NC	4

SEMI-INDUSTRIAL CHUTE PSIG-5472

170-03513

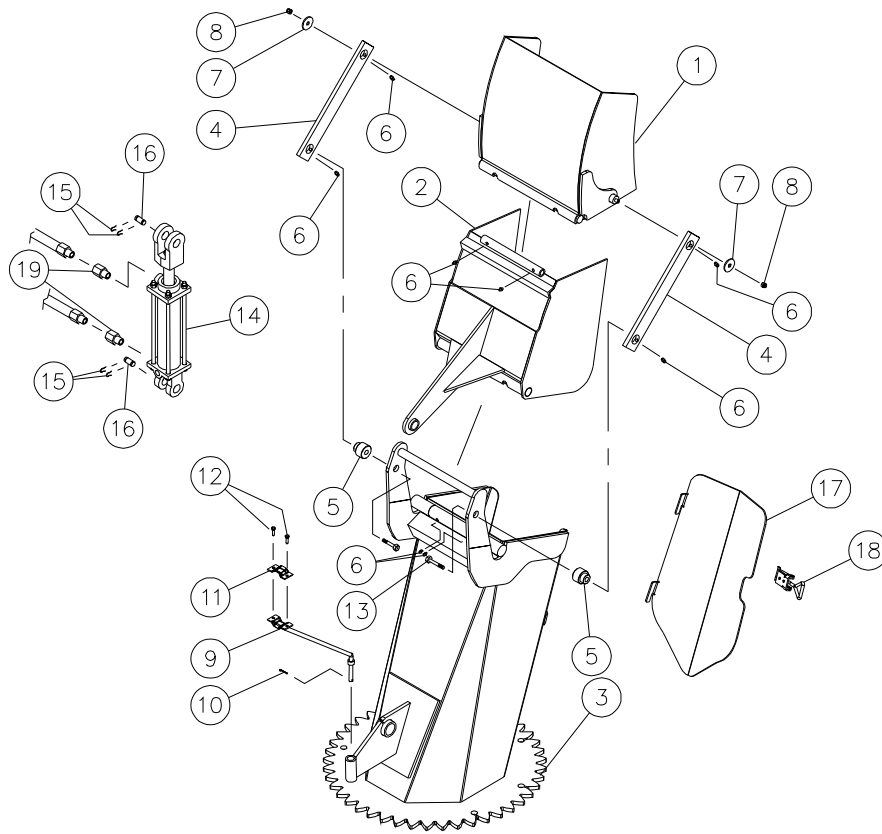

REF.	PART #	DESCRIPTION	QTY
1	110-22861	Upper chute deflector	1
2	110-22871	Lower chute deflector	1
3	110-36763	Chute base	1
4	140-14171	Connecting rod	2
5	150-05391	Spacer for connecting rod	2
6	Std.	Grease fitting 1/4" - 28 droit	8
7	378-36500	washer	2
8	346-36000	Nylon locknut 3/8" NC	2
9	110-01122	Mounting support plate (1)	opt.
10	Std.	Cotter pin 1/8" x 1" lg	opt.
11	140-13071	Hoses mounting plate (1)	opt.
12	300-32250	Bolt 1/4" NC x 1" lg + nylon locknut (1)	opt.
13	300-38340	Bolt 7/16" NC x 2" lg + nylon locknut	2
14	25TR04	Cylinder	opt.
15	Std.	Hairpin cotter 7/8" (4)	opt.
16	6004	Clevis pin 1" x 3 1/8" lg (2)	opt.
17	110-32762	Access panel	1
18	8374	Adjustable clamp fastener (welded)	1
19	RSP-1/16x06 NPT	Kit of two unidirectional restrictors 3/8" NPT	opt.
19	RSP-1/16x08 NPT	Kit of two unidirectional restrictors 1/2" NPT	opt.

10

P.T.O. SHAFT # 8202 (T60)

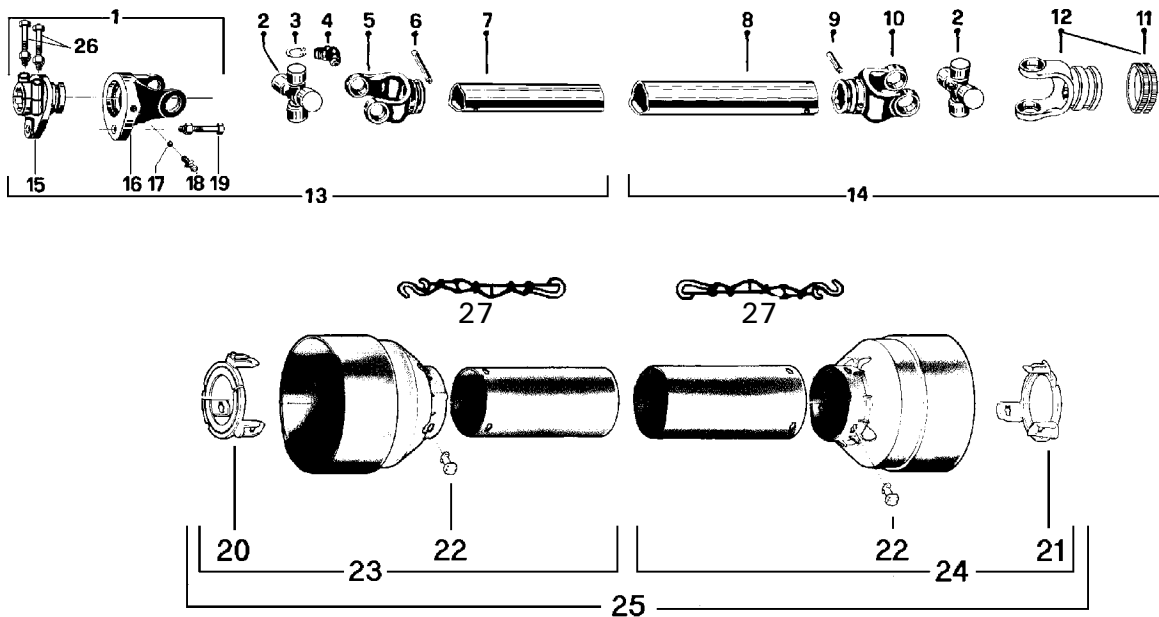

REF.	PART #	DESCRIPTION	QTY
1	8237	Safety shear yoke (2 bolts)	1
2	8238	U joint + 4 retaining rings + 1 grease fitting	2
3	8061	Retaining ring	8
4	8110	Grease fitting	2
5	8239	Yoke for inner tube	1
6	8075	Stopper for inner tube	1
7	8077	Inner tube	1
8	9212	Outer tube	1
9	9210-E	Stopper for outer tube	1
10	8240	Yoke for outer tube	1
11	8363	Collar kit	1
12	8250	Yoke with hole 1 3/8"-6 splines + yoke stopper (#11 included)	1
13	8241	P.T.O. section, SBI 1 3/8"-6, inner part, with protector	1
14	8242	P.T.O. section, QD 1 3/8"-6, outer part, with protector	1
15	8243	Adaptor (2 bolts)	1
16	8244	Yoke and shearplate	1
17	9205	Ball	17
18	8071	Grease fitting	1
19	8218	Safety shear bolt M10 x 60mm	1
20	8245	Bearing ring for inner guard tube	1
21	8246	Bearing ring for outer guard tube	1
22	8109	Stopper	6
23	8247	Inner shield	1
24	8248	Outer shield	1
25	8249	Complete shield	1
26	8222	Bolt M12 x 70mm + lock nut	2
27	8308	Safety chain	2

GEAR BOX # 8251 (T27D)

170-05581

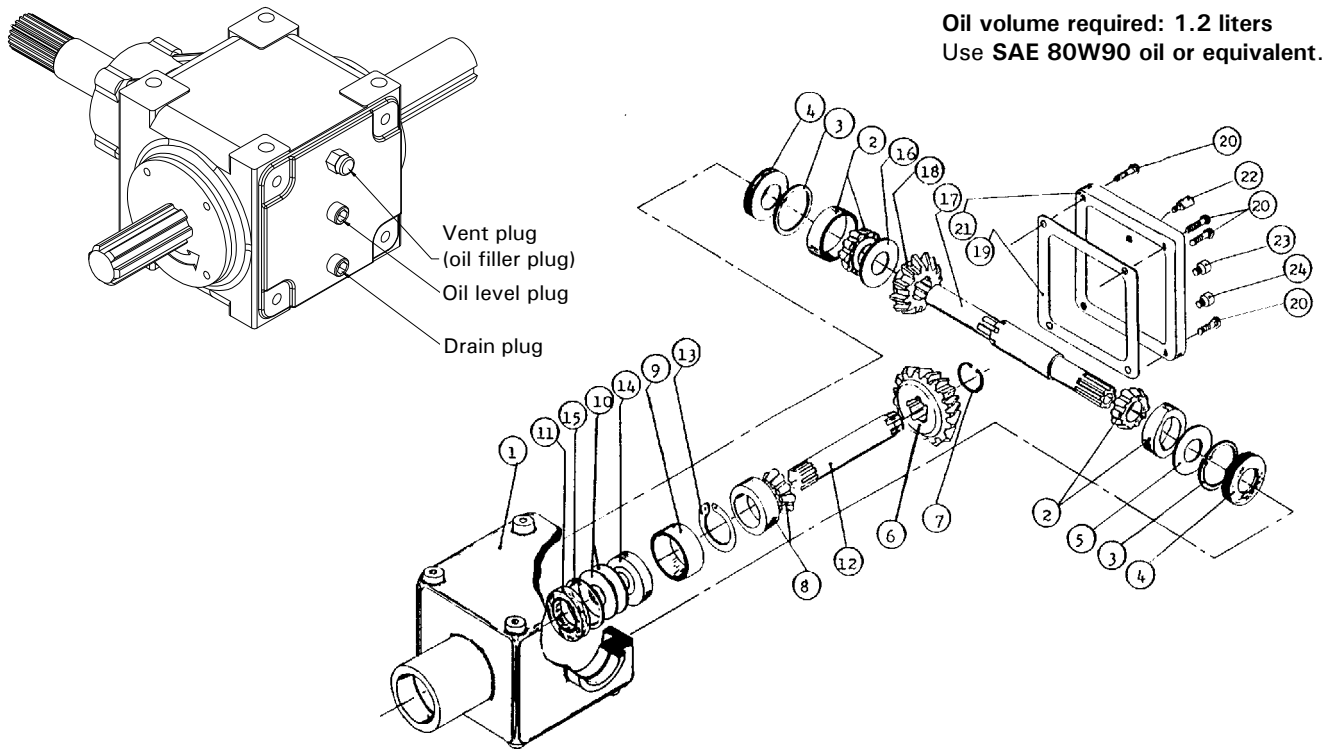

REF.	PART #	DESCRIPTION	QTY
1	8043	Casing	1
2	30208-A	Roller bearing	2
3	8045	Inside circlip 80mm	2
4	8046	Oil seal 40 x 80 x 12mm	2
5	8047	Adjusting washer	1
6	8048	Gear Z18	1
7	8049	Outside circlip 40mm	1
8	30207-A	Roller bearing	1
9	8051	Spacer ring	1
10	8052	Adjusting washer	2
11	8053	Oil seal 35 x 72 x 12mm	1
12	8054	Side shaft (1 1/4" - 19 splines)	1
13	8055	Inside circlip 72mm	1
14	6207-2RS	Ball bearing	1
15	8057	Outside circlip 35mm	1
16	8058	Adjusting washer	1
17	8252	Impeller shaft (1.575" & 1 3/8" - 6 splines)	1
18	8060	Gear Z-18	1
19	- - -	Use silicone caulking	-
20	8062	Bolt M10 x 14mm	4
21	8063	Cover	1
22	8065	Vent plug (oil filler plug)	1
23	8064	Plug (oil level)	1
24	8064	Plug (oil drain)	1

10

CYLINDER 25TR04

170-02141

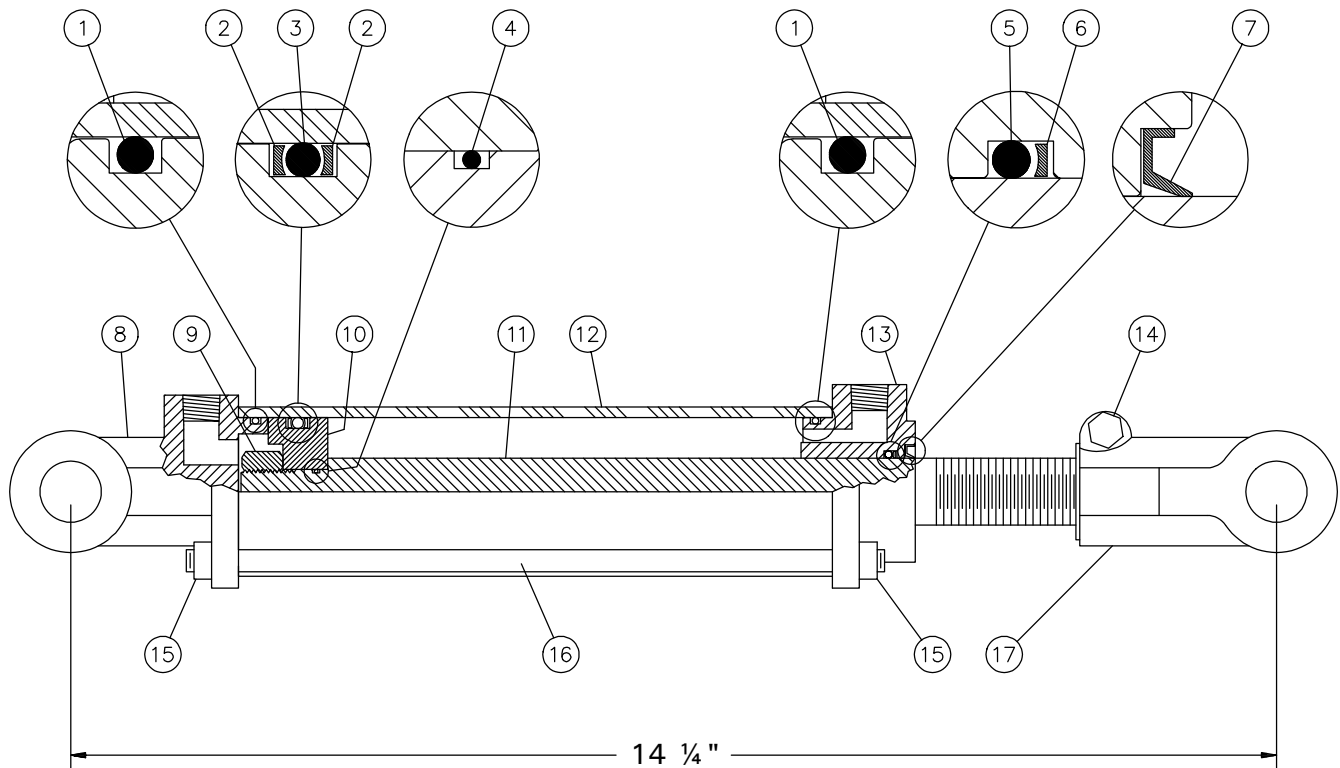

REF.	PART #	DESCRIPTION	QTY
1	See #RK25TR	O-ring 1/8" x 2 1/4" x 2 1/2"	2
2	See #RK25TR	Back-up 2 1/2" o.d. x 3/16 ø	2
3	See #RK25TR	O-ring 3/16" x 2 1/8" x 2 1/2"	1
4	See #RK25TR	O-ring 1/16" x 5/8" x 3/4"	1
5	See #RK25TR	O-ring 1/8" x 1 1/8" x 1 3/8"	1
6	See #RK25TR	Back-up 1 3/8" o.d. x 1/8" ø	1
7	See #RK25TR	Wiper 1 1/8" i.d. x 1 5/8" o.d.	1
8	492401	Yoke (for 2 1/2" tube)	1
9	338-46000	Nut 3/4" NF	1
10	4924-31	Piston 2 1/2" ø	1
11	491980-04	Piston rod 1 1/8"	1
12	491668-04	Cylinder body 2 1/2" ø	1
13	492421	Head (for 2 1/2" tube)	1
14	300-36355	Bolt 3/8" NC x 2 1/4" + nut	1
15	336-36000	Nut 3/8" NC	8
16	Std.	Threaded rod 3/8" NC x 8" lg	4
17	458599	Yoke (for 1 1/8" rod)	1
NI*	8183	Pin 1" ø + cotter pin	2
NI*	RK25TR	Repair kit for cylinder 2 1/2" (includes # 1, 2, 3, 4, 5, 6, & 7)	1

*NI = NOT ILLUSTRATED

HYDRAULIC MOTOR MLH250

CUSHION VALVE H110

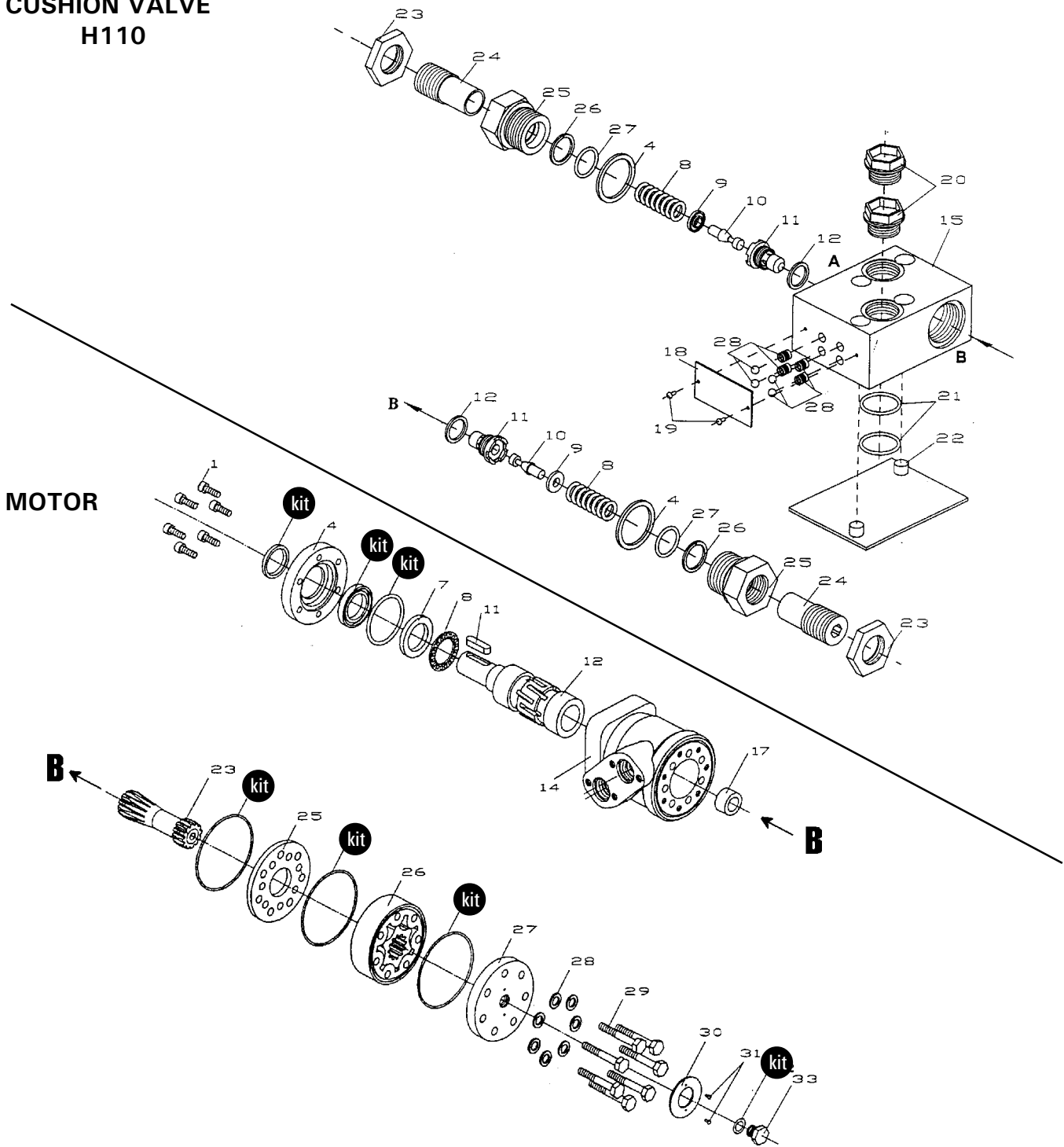







10





REF.	PART #	DESCRIPTION	QTY
kit	8368	Set of seals.....	1
11	8369	Key for "Orbit" motor.....	1

TORQUE CHART

TORQUE SPECIFICATION TABLE

Thread UNC and UNF		Grade 2 				Grade 5   				Grade 8*   			
Bolt size		Torque				Torque				Torque			
Inches	mm	Pound feet min.	max.	Newton meters min.	max.	Pound feet min.	max.	Newton meters min.	max.	Pound feet min.	max.	Newton meters min.	max.
1/4	6.35	5	6	6.8	8.13	9	11	12.2	14.9	12	15	16.3	30.3
5/16	7.94	10	12	13.6	16.3	17	20.5	23.1	27.8	24	29	32.5	39.3
3/8	9.53	20	23	27.1	31.2	35	42	47.5	57.0	45	54	61.0	73.2
7/16	11.11	30	35	40.7	47.4	54	64	73.2	86.8	70	84	94.9	113.9
1/2	12.70	45	52	61.0	70.5	80	96	108.5	130.2	110	132	149.2	179.0
9/16	14.29	65	75	88.1	101.6	110	132	149.2	179.0	160	192	217.0	260.4
5/8	15.88	95	105	128.7	142.3	150	180	203.4	244.1	220	264	298.3	358.0
3/4	19.05	150	185	203.3	250.7	270	324	366.1	439.3	380	456	515.3	618.3
7/8	22.23	160	200	216.8	271.0	400	480	542.4	650.9	600	720	813.6	976.3
1	25.40	250	300	338.8	406.5	580	696	786.5	943.8	900	1080	1220.4	1464.5
1 1/8	25.58	-	-	-	-	800	880	1084.8	1193.3	1280	1440	1735.7	1952.6
1 1/4	31.75	-	-	-	-	1120	1240	1518.7	1681.4	1820	2000	2467.9	2712.0
1 3/8	34.93	-	-	-	-	1460	1680	1979.8	2278.1	2380	2720	3227.3	3688.3
1 1/2	38.10	-	-	-	-	1940	2200	2630.6	2983.2	3160	3560	4285.0	4827.4

* Thick nuts must be used with grade 8 bolts.

Size of screw	Thread	Pitch (mm)	Grade 4T  				Grade 7T 				Grade 8T  			
			Torque				Torque				Torque			
			Pound feet min.	max.	Newton meters min.	max.	Pound feet min.	max.	Newton meters min.	max.	Pound feet min.	max.	Newton meters min.	max.
M6	UNC	1.00	3.6	5.8	4.9	7.9	5.8	9.4	7.9	12.7	7.2	10	9.8	13.6
M8	UNC	1.25	7.2	14	9.8	19	17	22	23	29.8	20	26	27.1	35.2
M10	UNC	1.5	20	25	27.1	33.9	34	40	46.1	54.2	38	46	51.5	62.3
M12	UNC	1.75	28	34	37.9	46.1	51	59	69.1	79.9	57	66	77.2	89.4
M14	UNC	2.0	49	56	66.4	75.9	81	93	109.8	126	96	109	130.1	147.7
M16	UNC	2.0	67	77	90.8	104.3	116	130	157.2	176.2	129	145	174.8	196.5
M18	UNC	2.0	88	100	119.2	136	150	168	203.3	227.6	175	194	237.1	262.9
M20	UNC	2.5	108	130	146.3	176.2	186	205	252	277.8	213	249	288.6	337.4
M8	UNF	1.0	12	17	16.3	23	19	27	25.7	36.6	22	31	29.8	42
M10	UNF	1.25	20	29	27.1	39.3	35	47	47.4	63.7	40	52	54.2	70.5
M12	UNF	1.25	31	41	42	55.6	56	68	75.9	92.1	62	75	84	101.6
M14	UNF	1.5	52	64	70.5	86.7	90	106	122	143.6	107	124	145	168
M16	UNF	1.5	69	83	93.5	112.5	120	138	162.6	187	140	158	189.7	214.1
M18	UNF	1.5	100	117	136	158.5	177	199	239.8	269.6	202	231	273.7	313
M20	UNF	1.5	132	150	178.9	203.3	206	242	279.1	327.9	246	289	333.3	391.6

Use the above torques when special torque is not given.

NOTE: These values apply to fasteners as received from supplier, dry, or when lubricated with normal engine oil. They do not apply if extreme pressure lubricants are used.

WARRANTY

12

PRONOVOST warrants this product to the initial purchaser for the period of one year from the date of purchase against defects in materials and workmanship.

We will replace or repair defective parts free of charge if they are returned to our plant in St-Tite, Quebec, Canada.

Transportation charges are the responsibility of the customer. This warranty is not transferable.

Hydraulic cylinders and motors are covered by the manufacturer of these items.

The PTO shafts are warranted by the manufacturer and cover **only** defects in material and workmanship, and is conditional to recommended use and installation only.

All PRONOVOST spare parts purchased are covered by a three (3) month warranty.

This warranty becomes void and nul if the equipment is modified, breaks down as the result of an accident, is not operated according to manufacturer's recommendations, damaged by negligence or if maintenance has not been carried out as specified.

Our obligation is limited to the replacement or repair of the defective part. PRONOVOST accepts no responsibility for direct or indirect consequential damages of any kind.

Ce manuel est aussi disponible en français.
Veuillez téléphoner.



LES MACHINERIES PRONOVOST INC.
260, Haut du Lac Sud (route 159),
Saint-Tite, Quebec, Canada, G0X 3H0
Tel.: (418) 365-7551, Fax: (418) 365-7954
www.pronovost.qc.ca