



# GENERAL PURPOSE AUGERS



FOR USE ON THE FOLLOWING CARRIES

One-Man Power Units,  
Two-Man Units, Tractors, Mini Skid Steers,  
Skid Steers, Mini Excavators and Backhoes



# PENGO AUGER SOIL CHART

Pengo has developed the below chart to help you decide which auger will be best suited for your project. The above triangles and color guide will be included with all products where applicable.



<b>1</b>	dirt; peat, organic silts, very loose sand, very soft, swamp, marsh	soil abrasion: low
<b>2</b>	sand; loose, fine sand; loess and medium clay, flood plain soils, lake clay	soil abrasion: medium
<b>3</b>	silt; coarse sand to stiff clay, dense hydraulic fill, compacted fill, residual soils	soil abrasion: high
<b>4</b>	clay; stiff to very stiff clay, glacial till, hard-pan, marls	soil abrasion: low to medium
<b>5</b>	gravel; basalt, very hard silts and clay, weathered laminated rock	soil abrasion: high
<b>6</b>	fracturable rock; caliche, coarse gravel and cobbles; frozen soil	soil abrasion: high
<b>7</b>	non-fracturable rock; granite, basalt, massive limestone	soil abrasion: high

## PENGO GP AUGERS

Pengo will commonly refer to the "parts" of the auger to help determine which one is suitable to your needs. Please use the diagram to the right as a reference guide when determining out the auger you would like quoted.

Carrier	Auger(s) Compatible
One-Man	HH Auger
Two-Man	CS Auger
Tractor	PTO Aggressor, AG Aggressor®
Mini Skid Steer	Landscape Aggressor®
Skid Steer	Aggressor®, Tree Aggressor®, TriMax®, GP Step Rock, Severe Rock Ripper®
Mini Excavator	Aggressor®, Tree Aggressor®, TriMax®, GP Step Rock, Severe Rock Ripper®
Backhoe	Aggressor®, Tree Aggressor®, TriMax®, GP Step Rock, Severe Rock Ripper®

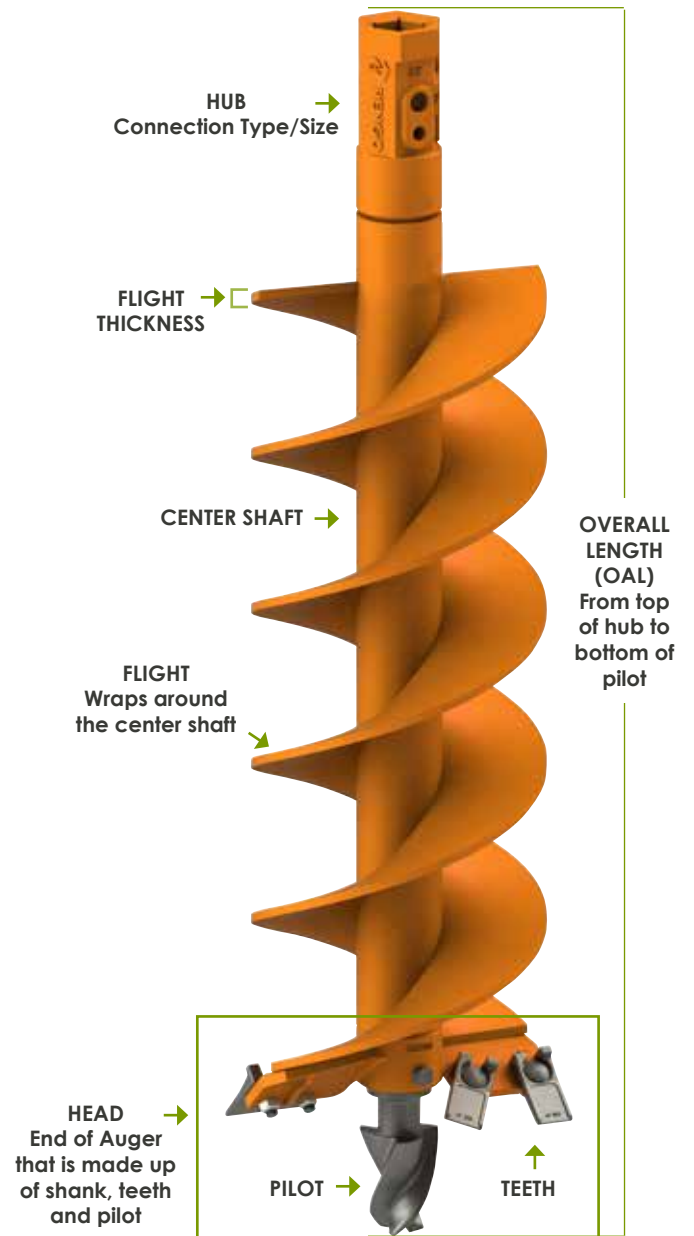

# HAND HELD AUGER



For Use With One-Man Power Units

36" OAL

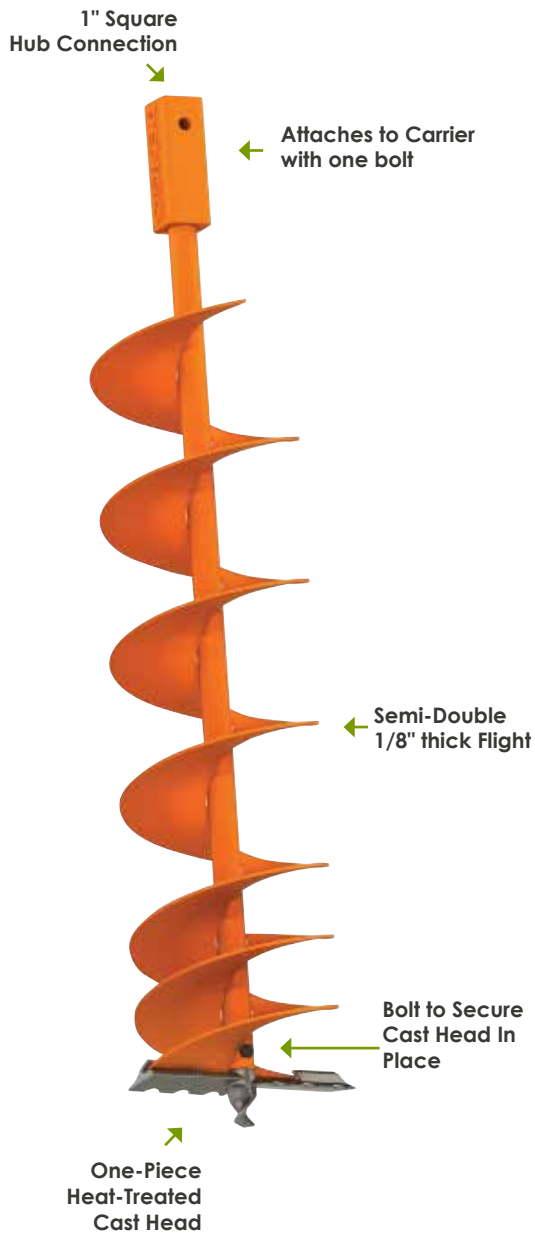

## CONNECTIONS

SQUARE 1"

## AUGER DIAMETERS

4" 6" 8"

## CUT DIAMETER

True Cut Diameter; hole will be cut the size the diameter of the auger.

## DRILLING SOIL CONDITIONS:

HIGHLY RECOMMENDED

NOT RECOMMENDED



The Pengo's Hand Held Auger (HH Auger) is designed for one-man operation and is ideal for those light duty landscaping and fencing applications that require holes up to 8" in diameter and 36" in depth. Maintenance is made simple by the use of a one-piece head-treated cast head; just insert, turn, and bolt.

# HAND HELD AUGER



## AUGERS | 36" Overall Length

ITEM	DIA	LBS	PN
4-HH-36	4"	7	137293
6-HH-36	6"	9	137294
8-HH-36	8"	14	137295

### THE NUTS & BOLTS: for Cast Head

G5 Bolt [PN 151662](#)  
G5 Hex Nut Lock [PN 174512](#)



### GET ATTACHED!

One-piece head for quick replacement. The auger flight fits securely under the heads tabs to hold in place.

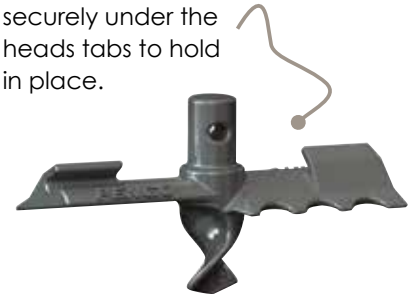

## PARTS | Replacement Head



<b>4" CAST HEAD</b>
<b>LBS</b>   .7
<b>PN</b>   137290



<b>6" CAST HEAD</b>
<b>LBS</b>   .9
<b>PN</b>   137291



<b>8" CAST HEAD</b>
<b>LBS</b>   1.1
<b>PN</b>   137292

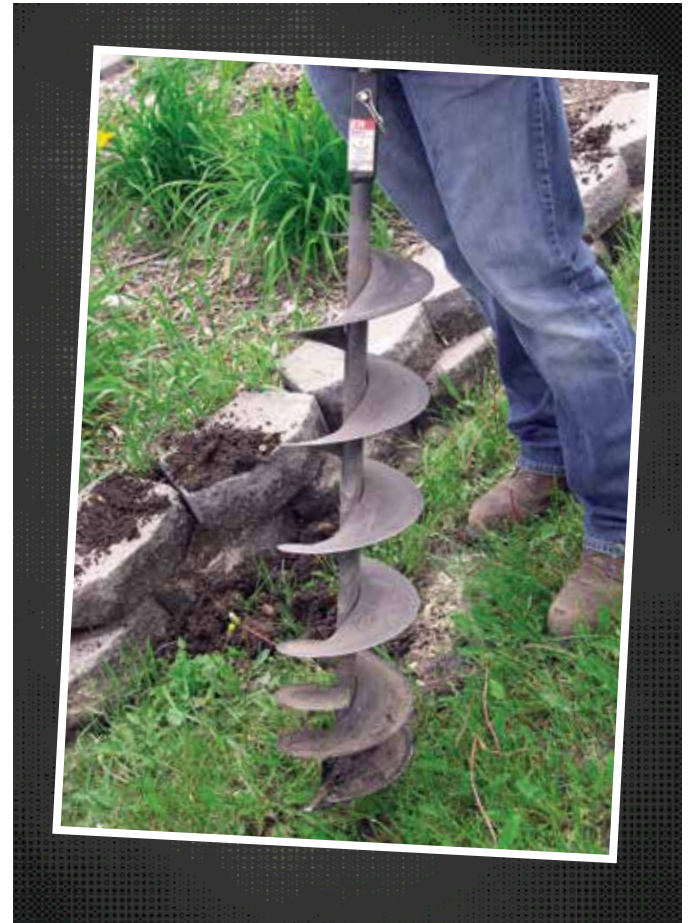

# GENERAL PURPOSE AUGERS

## CS AUGER



For Use With Two-Man Power Units

### 36" and 42" OAL



Choose the connection that best fits your power unit. (See list to the right.)

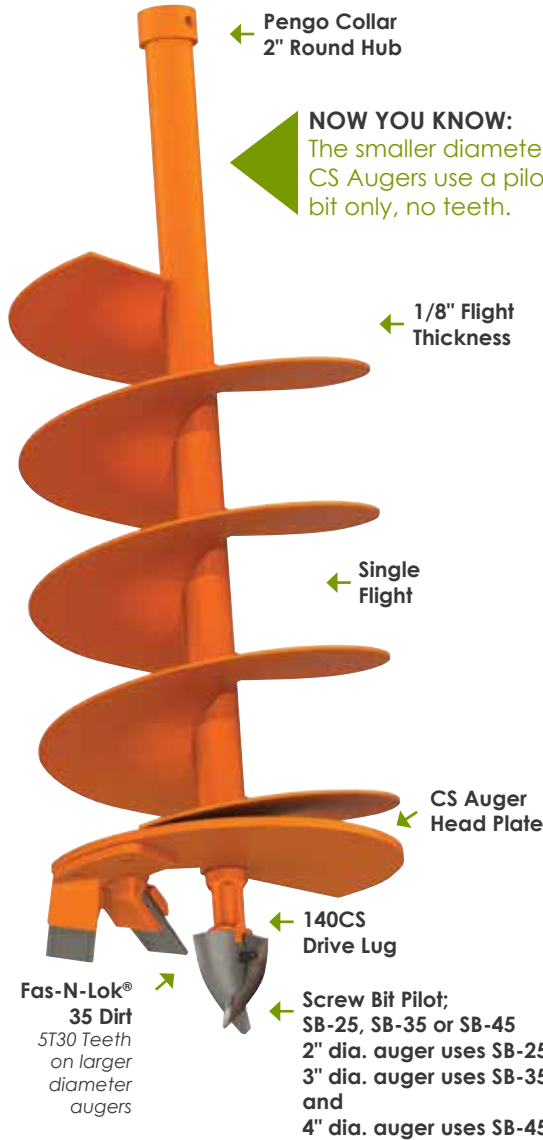

Pengo Collar 2" Round Hub

**NOW YOU KNOW:**  
The smaller diameter CS Augers use a pilot bit only, no teeth.

1/8" Flight Thickness

Single Flight

CS Auger Head Plate

140CS Drive Lug

Fas-N-Lok® 35 Dirt 5T30 Teeth on larger diameter augers

Screw Bit Pilot; SB-25, SB-35 or SB-45  
2" dia. auger uses SB-25  
3" dia. auger uses SB-35 and  
4" dia. auger uses SB-45

#### CONNECTIONS

**ROUND SQUARE**

- 7/8" GROUNDHOG
- 1 1/4" LITTLE BEAVER

**ROUND**

- 1 1/4" STIHL
- 1" GENERAL
- 2" PENGO

**HEX**

- 1 3/8" GENERAL

#### AUGER DIAMETERS

2" 3" 4" 6" 7" 8" 9" 10"  
12" 14" 16" 18" 18"

#### CUT DIAMETER

Cut diameter is 1 1/2" larger than auger diameter.

### DRILLING SOIL CONDITIONS:



The Pengo's CS hand held Auger is specifically developed for two-man power units and those applications requiring high duty cycles. Designed for the true professional, the CS line provides the flexibility to fit a variety of hub sizes. Maintenance remains simple and fast with Pengo's custom designed Fas-N-Lok® tooth design.

### STANDARD HUBS AVAILABLE:



	HUB SIZE	MFG
1.	1 3/8" Hex	General
2.	7/8" Square	Groundhog
3.	1 1/4" Round with Lock	Stihl
4.	1" Round	General
5.	2" Round	Pengo
6.	1 1/4" Square	Little Beaver

# GENERAL PURPOSE AUGERS

## CS AUGER



### PARTS | Pilot Bits

**FISH-TAIL PILOTS:**  
25 = 2.5", 35 = 3.5"  
and 45 = 4.5"

ITEM		LBS	PART NO.
SB-25		.6 LBS	131740
SB-35		1.2 LBS	133402
SB-45		3 LBS	133407
SB-25 HF		.6 LBS	131740
SB-35 HF		2.1 LBS	133405
SB-45 HF		3.2 LBS	133410
SB-25 HFTC		1.4 LBS	132590
SB-35 HFTC		2.8 LBS	133406
SB-45 HFTC		3.2 LBS	133411
SB-25C		.3 LBS	132135
SB-35 C		1.2 LBS	133403
SB-45 C		3.1 LBS	133408
SB-25 CXC		1 LBS	132758



Pengo Pilots and Teeth are rated for drilling conditions that may or may not be applicable to your power source. Refer to the soil chart listed on page 2 of this catalog to determine which tooth type is right for the job.



Standard

Hardfaced (HF)

Hardfaced Tungsten Carbide (HFTC)

Carbide (C)

Carbide Tipped (CXC)

### PARTS | Fas-N-Lok® Teeth

ITEM		LBS	PART NO.
35		.4 LBS	133835
5T30		.4 LBS	140029
35 HF		.6 LBS	140008
35 HFF		.6 LBS	140009
5T30 HF		.4 LBS	140014
35 C		.4 LBS	140007
5T30 C		.4 LBS	140012
1336L C		.6 LBS	140016
RB-5T30		.4 LBS	140013
RB-36LC		.6 LBS	140021

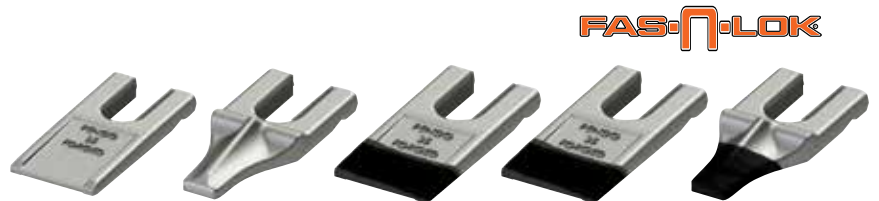

35 Dirt

5T30

35HF

35HFF

5T30HF



35C

5T30C

1336L C

RB-5T30

RB-36L C

#### DRIFT PUNCH

LBS | 1

PN | 137750

For Easy Removal of Teeth Use this Drift Punch.

#### SOFT HAMMER

LBS | 3.5

PN | 137737

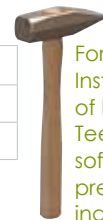

For Easy Installation of Fas-N-Lok® Teeth Use a soft hammer to prevent breaking of tips.

### PARTS | Holders

#### T-35 HOLDER

LBS | 1

PN | 171221



#### T-36 HOLDER

LBS | 1

PN | 171231

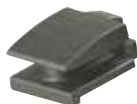

### PARTS | Drive Lugs

#### 140 CS

LBS | 1

PN | 151930



#### 140 S

LBS | .5

PN | 151940



#### GET ATTACHED!

The SB-25, -35 and -45 bits use the 140CS Pilot Bit Adapter PN 151930

#### GET TOUGH!

Shipped with standard pilot and teeth, you may order additional upgraded hard-faced or carbide parts for your tough drilling conditions.

## GENERAL PURPOSE AUGERS

# CS AUGER



### AUGERS | 36" Overall Length

#### 7/8" SQUARE CONNECTION

ITEM	DIA	NO. TEETH	LBS	PN
2-CS-36	2"	0	8	553295
3-CS-36	3"	0	10	553296
4-CS-36	4"	0	17	553297
6-CS-36	6"	1	18	553298
7-CS-36	7"	1	18	553299
8-CS-36	8"	2	23	553301
9-CS-36	9"	2	27	553302
10-CS-36	10"	2	27	553303
12-CS-36	12"	2	30	553304
14-CS-36	14"	2 out / 3 in	38	135902
16-CS-36	16"	2 out / 3 in	45	553306
18-CS-36	18"	2 out / 3 in	47	553307

#### 1" ROUND CONNECTION

ITEM	DIA	NO. TEETH	LBS	PN
2-CS-36	2"	0	8	101368
3-CS-36	3"	0	10	101369
4-CS-36	4"	0	17	101370
6-CS-36	6"	1	18	101371
7-CS-36	7"	1	18	101372
8-CS-36	8"	2	23	101373
9-CS-36	9"	2	27	101374
10-CS-36	10"	2	27	101375
12-CS-36	12"	2	30	101376
14-CS-36	14"	2 out / 3 in	38	101377
16-CS-36	16"	2 out / 3 in	45	101378
18-CS-36	18"	2 out / 3 in	47	101379

**Hub Connections:**  
 7/8" Square  
 Groundhog,  
 1" Round  
 General,  
 STIHL 1 1/4"  
 Round,  
 1 1/4" Square  
 Little Beaver,  
 1 3/8" Hex  
 General,  
 2" Pengo  
 Collar

#### STIHL CONNECTION

ITEM	DIA	NO. TEETH	LBS	PN
2-CS-36	2"	0	8	101780
3-CS-36	3"	0	10	
4-CS-36	4"	0	17	101599
6-CS-36	6"	1	18	101652
7-CS-36	7"	1	18	
8-CS-36	8"	2	23	
9-CS-36	9"	2	27	
10-CS-36	10"	2	27	101727
12-CS-36	12"	2	30	101677
14-CS-36	14"	2 out / 3 in	38	
16-CS-36	16"	2 out / 3 in	45	101743
18-CS-36	18"	2 out / 3 in	47	

#### 1 3/8" HEX CONNECTION

ITEM	DIA	NO. TEETH	LBS	PN
2-CS-36	2"	0	8	
3-CS-36	3"	0	10	
4-CS-36	4"	0	17	101697
6-CS-36	6"	1	18	101618
7-CS-36	7"	1	18	
8-CS-36	8"	2	23	101578
9-CS-36	9"	2	27	
10-CS-36	10"	2	27	101559
12-CS-36	12"	2	30	101546
14-CS-36	14"	2 out / 3 in	38	
16-CS-36	16"	2 out / 3 in	45	
18-CS-36	18"	2 out / 3 in	47	

The CS Auger item numbers are for standard augers only. These augers will be shipped with standard teeth and pilot. You may order additional upgraded wear parts to enhance the drilling capabilities of your auger.

#### 1 1/4" SQUARE CONNECTION

ITEM	DIA	NO. TEETH	LBS	PN
2-CS-36	2"	0	8	102164
3-CS-36	3"	0	10	102165
4-CS-36	4"	0	17	101739
6-CS-36	6"	1	18	101602
7-CS-36	7"	1	18	101538
8-CS-36	8"	2	23	101544
9-CS-36	9"	2	27	101669
10-CS-36	10"	2	27	101535
12-CS-36	12"	2	30	101545
14-CS-36	14"	2 out / 3 in	38	102177
16-CS-36	16"	2 out / 3 in	45	
18-CS-36	18"	2 out / 3 in	47	

#### 2" PENG0 COLLAR

ITEM	DIA	NO. TEETH	LBS	PN
2-CS-36	2"	0	8	101380
3-CS-36	3"	0	10	101381
4-CS-36	4"	0	17	101382
6-CS-36	6"	1	18	101383
7-CS-36	7"	1	18	101384
8-CS-36	8"	2	23	101385
9-CS-36	9"	2	27	101386
10-CS-36	10"	2	27	101387
12-CS-36	12"	2	30	101388
14-CS-36	14"	2 out / 3 in	38	101389
16-CS-36	16"	2 out / 3 in	45	101390
18-CS-36	18"	2 out / 3 in	47	101391

Special Orders Available upon request. Special orders cannot be canceled once ordered. Contact Pengo sales for special order requests.

## GENERAL PURPOSE AUGERS

# CS AUGER



### AUGERS | 42" Overall Length

#### 7/8" SQUARE CONNECTION

ITEM	DIA	NO. TEETH	LBS	PN
2-CS-42	2"	0	9	553311
3-CS-42	3"	0	11	133919
4-CS-42	4"	0	15	553313
6-CS-42	6"	1	20	553314
7-CS-42	7"	1	21	553316
8-CS-42	8"	2	25	553318
9-CS-42	9"	2	30	553319
10-CS-42	10"	2	30	553321
12-CS-42	12"	2	32	553323
14-CS-42	14"	2 out / 3 in	40	134711
16-CS-42	16"	2 out / 3 in	47	553324
18-CS-42	18"	2 out / 3 in	50	553326

#### 1" ROUND CONNECTION

ITEM	DIA	NO. TEETH	LBS	PN
2-CS-42	2"	0	9	101392
3-CS-42	3"	0	11	101393
4-CS-42	4"	0	15	101394
6-CS-42	6"	1	20	101395
7-CS-42	7"	1	21	101396
8-CS-42	8"	2	25	101397
9-CS-42	9"	2	30	101398
10-CS-42	10"	2	30	101399
12-CS-42	12"	2	32	101400
14-CS-42	14"	2 out / 3 in	40	101401
16-CS-42	16"	2 out / 3 in	47	101402
18-CS-42	18"	2 out / 3 in	50	101403

**Hub Connections:**  
 7/8" Square  
 Groundhog,  
 1" Round  
 General,  
 STIHL 1 1/4"  
 Round,  
 1 1/4" Square  
 Little Beaver,  
 1 3/8" Hex  
 General,  
 2" Pengo  
 Collar

#### STIHL CONNECTION

ITEM	DIA	NO. TEETH	LBS	PN
2-CS-42	2"	0	9	
3-CS-42	3"	0	11	103244
4-CS-42	4"	0	15	102584
6-CS-42	6"	1	20	101616
7-CS-42	7"	1	21	
8-CS-42	8"	2	25	101642
9-CS-42	9"	2	30	
10-CS-42	10"	2	30	102063
12-CS-42	12"	2	32	101726
14-CS-42	14"	2 out / 3 in	40	
16-CS-42	16"	2 out / 3 in	47	102064
18-CS-42	18"	2 out / 3 in	50	101725

#### 1 3/8" HEX CONNECTION

ITEM	DIA	NO. TEETH	LBS	PN
2-CS-42	2"	0	9	
3-CS-42	3"	0	11	
4-CS-42	4"	0	15	
6-CS-42	6"	1	20	101629
7-CS-42	7"	1	21	
8-CS-42	8"	2	25	101651
9-CS-42	9"	2	30	101701
10-CS-42	10"	2	30	101603
12-CS-42	12"	2	32	101604
14-CS-42	14"	2 out / 3 in	40	
16-CS-42	16"	2 out / 3 in	47	
18-CS-42	18"	2 out / 3 in	50	

The CS Auger item numbers are for standard augers only. These augers will be shipped with standard teeth and pilot. You may order additional upgraded wear parts to enhance the drilling capabilities of your auger.

#### 1 1/4" SQUARE CONNECTION

ITEM	DIA	NO. TEETH	LBS	PN
2-CS-42	2"	0	9	
3-CS-42	3"	0	11	
4-CS-42	4"	0	15	102352
6-CS-42	6"	1	20	101558
7-CS-42	7"	1	21	
8-CS-42	8"	2	25	101577
9-CS-42	9"	2	30	101692
10-CS-42	10"	2	30	101678
12-CS-42	12"	2	32	101650
14-CS-42	14"	2 out / 3 in	40	
16-CS-42	16"	2 out / 3 in	47	102124
18-CS-42	18"	2 out / 3 in	50	101791

#### 2" PENGU COLLAR

ITEM	DIA	NO. TEETH	LBS	PN
2-CS-42	2"	0	9	101404
3-CS-42	3"	0	11	101405
4-CS-42	4"	0	15	101406
6-CS-42	6"	1	20	101407
7-CS-42	7"	1	21	101408
8-CS-42	8"	2	25	101409
9-CS-42	9"	2	30	101410
10-CS-42	10"	2	30	101411
12-CS-42	12"	2	32	101412
14-CS-42	14"	2 out / 3 in	40	101413
16-CS-42	16"	2 out / 3 in	47	101414
18-CS-42	18"	2 out / 3 in	50	101415

Special Orders Available upon request. Special orders cannot be canceled once ordered. Contact Pengo sales for special order requests.



# AG AGGRESSOR<sup>®</sup> AUGER



For Use With PTO Driven Tractors

42" and 48" OAL

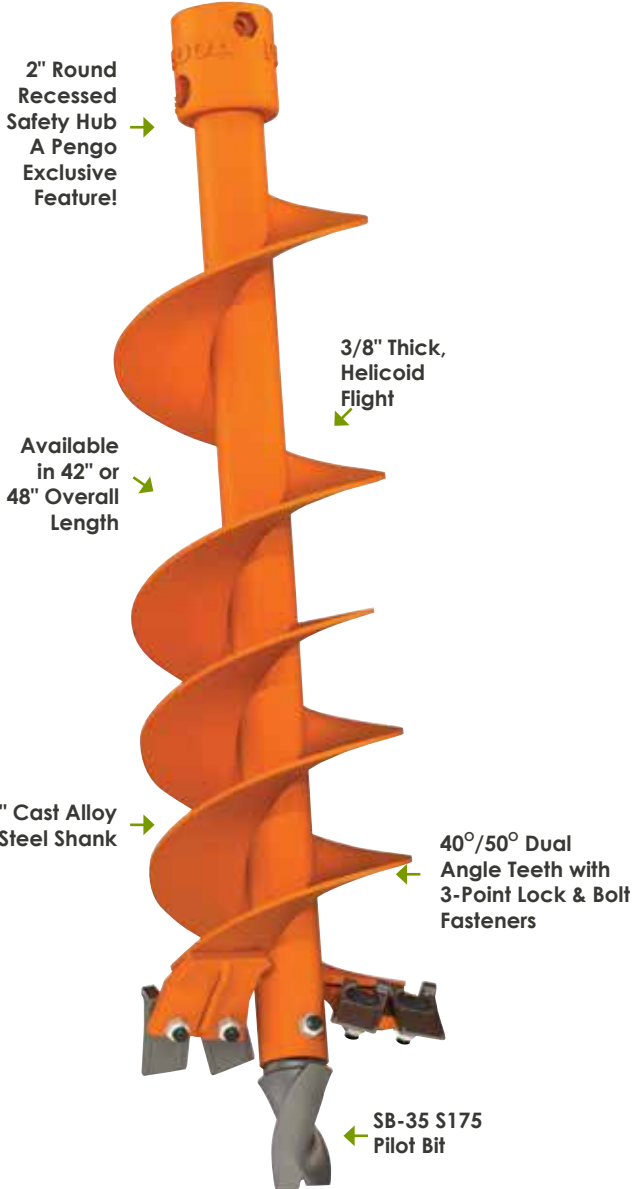

40°/50° Dual Angle Teeth with 3-Point Lock & Bolt Fasteners



**CONNECTIONS**

ROUND **2"**

**AUGER DIAMETERS**

6 9" 12"

**CUT DIAMETER**  
Cut diameter is 1 1/2" larger than auger diameter.

**DRILLING SOIL CONDITIONS:**



Pengo's Ag Aggressor<sup>®</sup> auger is designed for medium duty applications while remaining both cost efficient and safety focused. Featuring a 2" round safety hub, all hardware is recessed inside the hub to prevent all potential entanglements. Utilizing Pengo's two fluted pilot design, the Ag Aggressor<sup>®</sup> is a well rounded general purpose auger offering superior efficiency in dry, loose soil.



# AG AGGRESSOR<sup>®</sup> AUGER



## AUGERS | 42" Overall Length

ITEM	DIA	NO. TEETH	LBS	PN
6-LTA-42	6"	2	35	553225
9-LTA-42	9"	4	52	553226
12-LTA-42	12"	4	58	553227

## AUGERS | 48" Overall Length

ITEM	DIA	NO. TEETH	LBS	PN
6-LTA-48	6"	2	45	553228
9-LTA-48	9"	4	52	553229
12-LTA-48	12"	4	68	553230



Pengo Pilots and Teeth are rated for drilling conditions that may or may not be applicable to your power source. Refer to the soil chart listed on page 2 of this catalog to determine which tooth type is right for the job.



## PARTS | Pilot Bits

<b>SB-35 S175</b>
<b>LBS   3.9</b>
<b>PN   151318</b>



The SB-35 two-fluted pilot is ideal for dry soil conditions.

## PARTS | Teeth

<b>40/50 Tooth</b>
<b>LBS   .5</b>
<b>PN   134501</b>



<b>40/50HFF Tooth</b>
<b>LBS   .5</b>
<b>PN   134802</b>



<b>40/50C Tooth</b>
<b>LBS   .65</b>
<b>PN   134519</b>

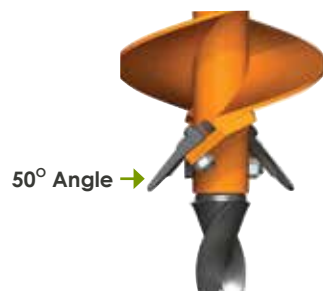
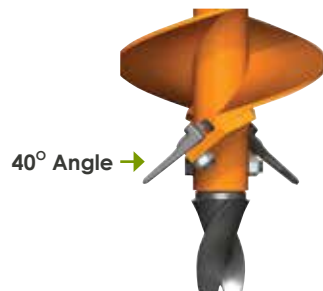

AGGRESSOR<sup>®</sup> auger teeth are for use in dirt, abrasive soil or fracturable rock, depending on the type of tooth you are using. All types of the 40/50 tooth can be used at either a 40° or 50° angle providing different attack angles based on your drilling condition.

### THE NUTS & BOLTS:

for 40/50 Teeth  
 Carriage Bolt PN 134677  
 Hex Nut Lock PN 134527



# PTO AGGRESSOR<sup>®</sup> AUGER



For Use With PTO Driven Tractors

30", 42" and 48" OAL

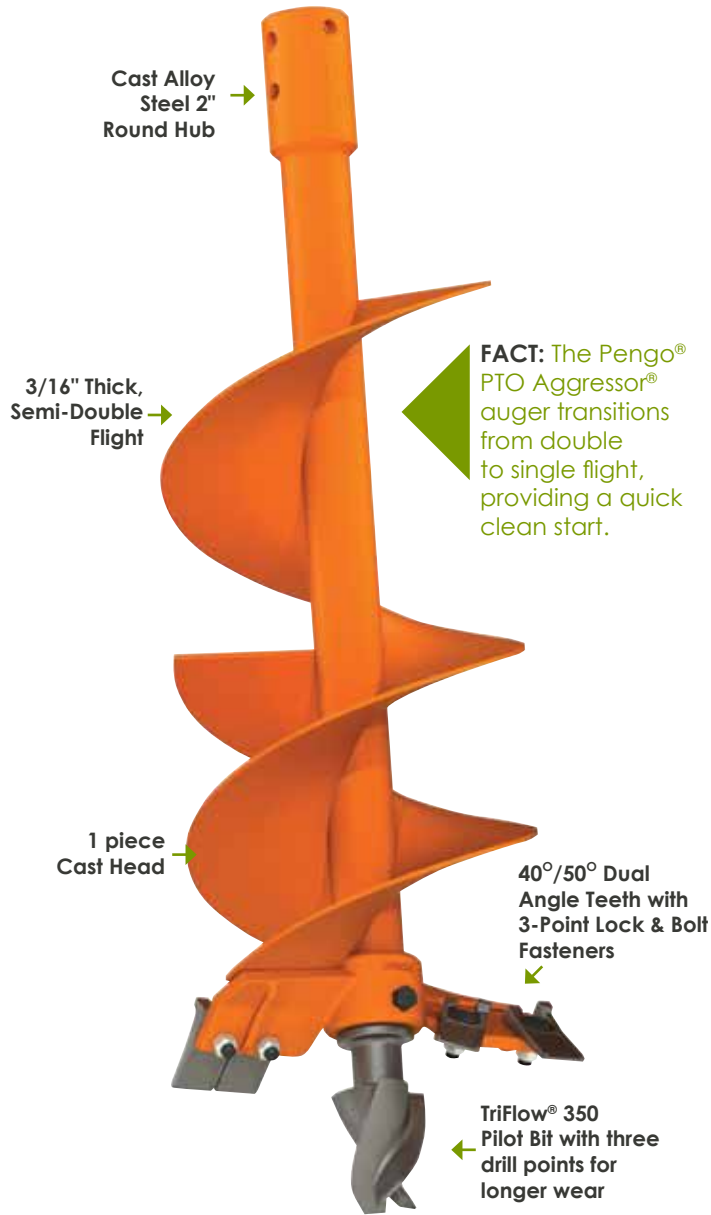

**CONNECTIONS**

ROUND **2"**

**AUGER DIAMETERS**

6" 9" 12" 15" 18" 24"

**CUT DIAMETER**  
Cut diameter is 1 1/2" larger than auger diameter.

**DRILLING SOIL CONDITIONS:**



Pengo's PTO Aggressor<sup>®</sup> is designed for professionals and offers superior performance and reliability under high-duty applications. Featuring the TriFlow<sup>®</sup> 350 pilot (an original Pengo<sup>®</sup> design) the PTO Aggressor<sup>®</sup> provides longer wear and exceptional performance in a wide variety of soil conditions.

40°/50° Dual Angle Teeth with 3-Point Lock & Bolt Fasteners



# PTO AGGRESSOR<sup>®</sup> AUGER



## AUGERS | 30" Overall Length

ITEM	DIA	NO. TEETH	LBS	PN
6-AR-PTO	6"	4	30	137140
9-AR-PTO	9"	4	39	137141
12-AR-PTO	12"	4	47	137142
15-AR-PTO	15"	5	53	137143
18-AR-PTO	18"	6	59	137144
24-AR-PTO	24"	8	65	137145

## AUGERS | 42" Overall Length

ITEM	DIA	NO. TEETH	LBS	PN
6-AR-PTO	6"	4	36	137151
9-AR-PTO	9"	4	42	137152
12-AR-PTO	12"	4	54	137153
15-AR-PTO	15"	5	58	137154
18-AR-PTO	18"	6	63	137155
24-AR-PTO	24"	8	67	137156
30-AR-PTO	30"	10	75	137157

## AUGERS | 48" Overall Length

ITEM	DIA	NO. TEETH	LBS	PN
6-AR-PTO	6"	4	40	137180
9-AR-PTO	9"	4	50	137181
12-AR-PTO	12"	4	59	137182
15-AR-PTO	15"	5	65	137183
18-AR-PTO	18"	6	72	137184
24-AR-PTO	24"	8	84	137185



## PARTS | TriFlow<sup>®</sup> Pilot Bits

  
**TF-350**  
**LBS | 5**  
**PN | 135088**

  
**TF-350HF Pilot**  
**LBS | 5.5**  
**PN | 135089**

  
**TF-350C Pilot**  
**LBS | 5.5**  
**PN | 135090**

  
**TF-350CXC Pilot**  
**LBS | 5.8**  
**PN | 135091**

  
**TF-350HFTC Pilot**  
**LBS | 5.5**  
**PN | 135092**



## PARTS | Teeth

  
**40/50 Tooth**  
**LBS | .5**  
**PN | 134501**

  
**40/50HFF Tooth**  
**LBS | .5**  
**PN | 134802**

  
**40/50C Tooth**  
**LBS | .65**  
**PN | 134519**

### THE NUTS & BOLTS:

for 40/50 Teeth  
 Carriage Bolt [PN 134677](#)  
 Hex Nut Lock [PN 134527](#)

for TriFlow 350 Pilot Bits  
 3.5" Hex Bolt (6"-9" dia.) [PN 174447](#)  
 4" Hex Bolt (12" plus dia.) [PN 174448](#)  
 Hex Nut Lock [PN 134527](#)



AGGRESSOR<sup>®</sup> auger teeth are for use in dirt, abrasive soil or fracturable rock, depending on the type of tooth you are using. All types of the 40/50 tooth can be used at either a 40° or 50° angle providing different attack angles based on your drilling condition.

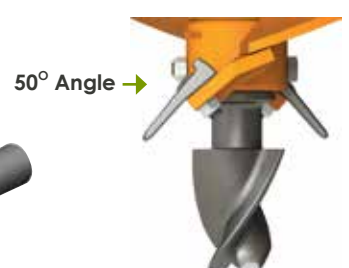
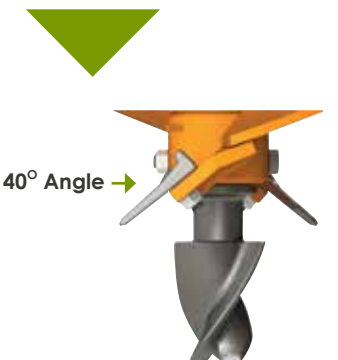

# LANDSCAPE AGGRESSOR<sup>®</sup> AUGER



Use with Revolution Series Drives: MS-100 and MS-125

42" and 48" OAL



**CONNECTIONS**

ROUND 2" 2 9/16"

HEX 2"

SQUARE 2"

**AUGER DIAMETERS**

6" 9" 12" 15" 18" 24" 30" 36"

**CUT DIAMETER**  
Cut diameter is 1 1/2" larger than auger diameter.

**DRILLING SOIL CONDITIONS:**



Pengo's Landscape Aggressor<sup>®</sup> is the perfect tool for landscaping applications or where smaller prime movers are required. Shorten flight bodies offers substantial weight reduction and performance is enhanced with our double entry flight design. Paired with our TriFlow<sup>®</sup> 350 pilot, providing three drill points for longer wear, the Landscape Aggressor<sup>®</sup> provides big performance in a small package.



# LANDSCAPE AGGRESSOR<sup>®</sup> AUGER



## AUGERS | 42" Overall Length

### 2" SQUARE

ITEM	DIA	NO. TEETH	LBS	PN
6-MA-42	6"	2	35	137876
9-MA-42	9"	4	42	137878
12-MA-42	12"	4	46	137880
15-MA-42	15"	5	50	137882
18-MA-42	18"	6	67	137884
24-MA-42	24"	8	85	137886
30-MA-42	30"	10	104	137888

### 2" ROUND

ITEM	DIA	NO. TEETH	LBS	PN
6-MA-42	6"	2	35	138000
9-MA-42	9"	4	42	138001
12-MA-42	12"	4	46	138002
15-MA-42	15"	5	50	138003
18-MA-42	18"	6	67	138004
24-MA-42	24"	8	85	138005
30-MA-42	30"	10	104	138008

The Landscape Aggressor<sup>®</sup> Auger item numbers are for standard augers only. These augers will be shipped with standard teeth and pilot. You may order additional upgraded wear parts to enhance the drilling capabilities of your auger.

### 2 9/16" ROUND

ITEM	DIA	NO. TEETH	LBS	PN
6-MA-42	6"	2	35	138100
9-MA-42	9"	4	42	138101
12-MA-42	12"	4	46	138102
15-MA-42	15"	5	50	138103
18-MA-42	18"	6	67	138104
24-MA-42	24"	8	85	138105
30-MA-42	30"	10	104	138106
36-MA-42	36"	12	125	138109

### 2" HEX

ITEM	DIA	NO. TEETH	LBS	PN
6-MA-42	6"	2	35	137894
9-MA-42	9"	4	42	137895
12-MA-42	12"	4	46	137890
15-MA-42	15"	5	50	137896
18-MA-42	18"	6	67	137891
24-MA-42	24"	8	85	137892
30-MA-42	30"	10	104	137893
36-MA-42	36"	12	220	137870

### 2 9/16" ROUND CARBIDE

ITEM	DIA	NO. TEETH	LBS	PN
6-MA-42	6"	2	35	138080
9-MA-42	9"	4	42	138082
12-MA-42	12"	4	46	138084
15-MA-42	15"	5	50	138086
18-MA-42	18"	6	67	138088
24-MA-42	24"	8	85	138090
30-MA-42	30"	10	104	138092
36-MA-42	36"	12	220	138094

### 2" ROUND CARBIDE

ITEM	DIA	NO. TEETH	LBS	PN
6-MA-42	6"	2	35	138000
9-MA-42	9"	4	42	138001
12-MA-42	12"	4	46	138002
15-MA-42	15"	5	50	138003
18-MA-42	18"	6	67	138004
24-MA-42	24"	8	85	138005
30-MA-42	30"	10	104	138008

30" OAL Landscape Aggressors available, call for details.

## AUGERS | 48" Overall Length

### 2 9/16" ROUND CARBIDE

ITEM	DIA	NO. TEETH	LBS	PN
6-MA-48	6"	2	35	138120
9-MA-48	9"	4	42	138121
12-MA-48	12"	4	46	138122
15-MA-48	15"	5	50	138123
18-MA-48	18"	6	67	138124
24-MA-48	24"	8	85	138125
30-MA-48	30"	10	104	138126

### 2" ROUND

ITEM	DIA	NO. TEETH	LBS	PN
6-MA-48	6"	2	35	102390
9-MA-48	9"	4	42	102391
12-MA-48	12"	4	46	102392
15-MA-48	15"	5	50	138015
30-MA-48	30"	10	104	138016

Special Orders Available upon request. Special orders cannot be canceled once ordered. Contact Pengo sales for special order requests.



# LANDSCAPE AGGRESSOR<sup>®</sup> AUGER



Use with Revolution Series Drives: MS-100 and MS-125

42" OAL

## AGGRESSOR<sup>®</sup>

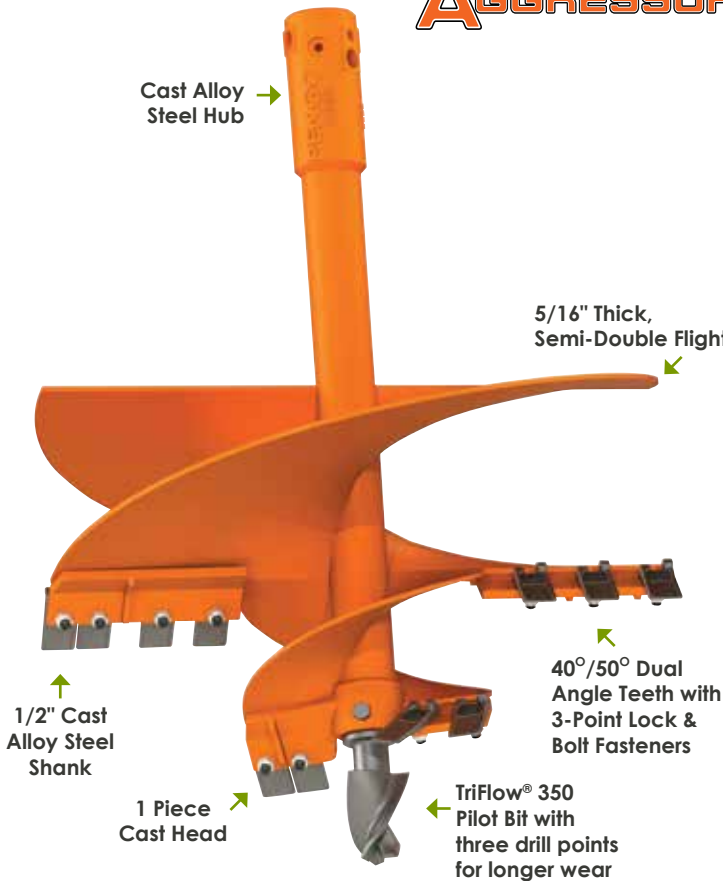

### CONNECTIONS



### AUGER DIAMETERS



### CUT DIAMETER

Cut diameter is 1 1/2" larger than auger diameter.

### DRILLING SOIL CONDITIONS:



2" ROUND

ITEM	DIA	NO. TEETH	LBS	PN
9/24-MA-42	9/24"	8	71	138006
12/30-MA-42	12/30"	11	75	138007

2" HEX

ITEM	DIA	NO. TEETH	LBS	PN
9/24-MA-42	9/24"	8	71	137871
12/30-MA-42	12/30"	11	75	137872

2 9/16" ROUND

ITEM	DIA	NO. TEETH	LBS	PN
9/24-MA-42	9/24"	8	71	138107
12/30-MA-42	12/30"	11	75	138108

2 9/16" ROUND CARBIDE

ITEM	DIA	NO. TEETH	LBS	PN
9/24-MA-42	9/24"	8	71	138096
12/30-MA-42	12/30"	11	75	138098

Pengo's Landscape Aggressor<sup>®</sup> Tree Auger is specifically designed for horticultural plantings. The two stage design produces a tailored fit for the root ball while providing additional clearance for proper backfilling as well as producing a non-glazed wall surface within the hole to maximize plant acclimation.

# LANDSCAPE AGGRESSOR<sup>®</sup> AUGER



## PARTS | TriFlow<sup>®</sup> Pilot Bits

**TF-350**

LBS | 5

PN | 135088



**TF-350CXC Pilot**

LBS | 5.8

PN | 135091



**TF-350HF Pilot**

LBS | 5.5

PN | 135089



**TF-350HFTC Pilot**

LBS | 5.5

PN | 135092



**TF-350C Pilot**

LBS | 5.5

PN | 135090



For convenient storage of your Pengo 2" Aggressor<sup>®</sup> augers, we have designed a simple metal base with a 2" Hex connection, that your auger can slip easily onto. Thus giving you a safe and out-of-the-way storage option.

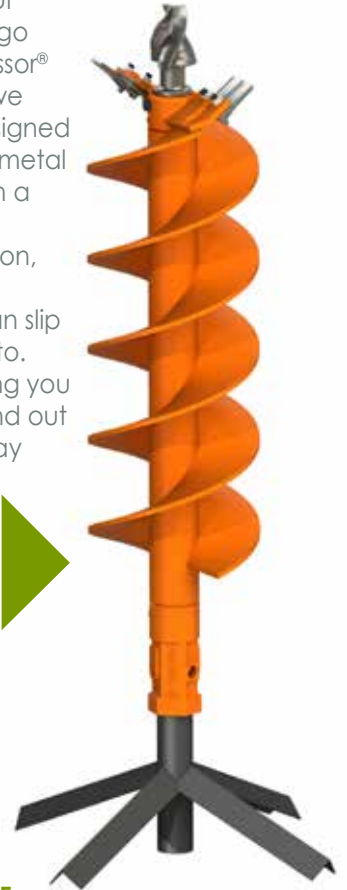

### STORAGE

**Auger Stand for Pengo Aggressor<sup>®</sup> Augers**

Standard Auger Stand PN 135102  
14 LBS.

## PARTS | Teeth

**40/50 Tooth**

LBS | .5

PN | 134501



**40/50HF Tooth**

LBS | .5

PN | 134802



**40/50C Tooth**

LBS | .65

PN | 134519



AGGRESSOR<sup>®</sup> auger teeth are for use in dirt, abrasive soil or fracturable rock, depending on the type of tooth you are using. All types of the 40/50 tooth can be used at either a 40° or 50° angle providing different attack angles based on your drilling condition.

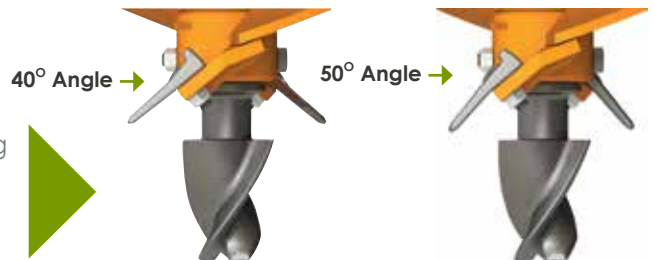

### THE NUTS & BOLTS:

for 40/50 Teeth  
Carriage Bolt PN 134677  
Hex Nut Lock PN 134527



for TriFlow 350 Pilot Bits  
3.5" Hex Bolt (6"-9" dia.) PN 174447  
4" Hex Bolt (12" plus dia.) PN 174448  
Hex Nut Lock PN 134527





## GENERAL PURPOSE AUGERS

# AGGRESSOR<sup>®</sup> AUGER



Use with Revolution Series Drives: DS-2 and DS-3

49" (6"-9" dia augers) 51" (12" and larger augers) OAL

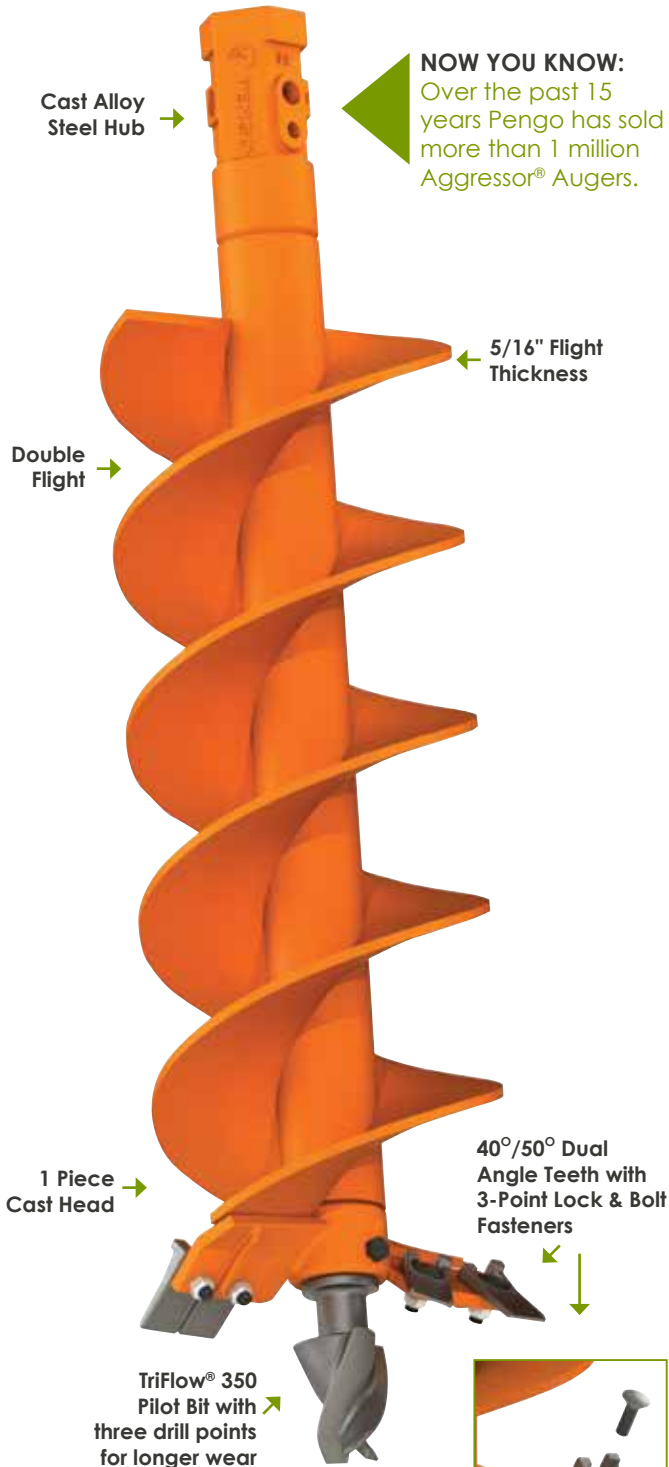

### CONNECTIONS



### AUGER DIAMETERS



### CUT DIAMETER

Cut diameter is 1 1/2" larger than auger diameter.

### DRILLING SOIL CONDITIONS:



Pengo's Aggressor<sup>®</sup> Auger is the standard in which all others are measured, a professional grade tool designed for daily and constant use. The patented Tri-Flow pilot provides unmatched auger stability as well as up to 50% longer wear over conventional pilot bits. Double flight technology provides maximum spoil removal and the 5/16" flight thickness provides the long term durability demanded for daily use.



## GENERAL PURPOSE AUGERS

# AGGRESSOR<sup>®</sup> AUGER



### AUGERS | 49" OAL (6" and 9") 51" OAL (12"-36")

2" HEX

ITEM	DIA	NO. TEETH	LBS	PN
6-AR-49	6"	2	54	135546
9-AR-49	9"	4	78	135547
12-AR-51	12"	4	114	135548
15-AR-51	15"	5	117	135549
18-AR-51	18"	6	145	135550
24-AR-51	24"	8	210	135551
30-AR-51	30"	10	225	135552
36-AR-51	36"	12	295	135553

2 9/16" ROUND

ITEM	DIA	NO. TEETH	LBS	PN
6-AR-49	6"	2	54	135534
9-AR-49	9"	4	78	135535
12-AR-51	12"	4	114	135536
15-AR-51	15"	5	117	135537
18-AR-51	18"	6	145	135538
24-AR-51	24"	8	210	135539
30-AR-51	30"	10	225	135540
36-AR-51	36"	12	295	135541

2" ROUND

ITEM	DIA	NO. TEETH	LBS	PN
6-AR-49	6"	2	54	135570
9-AR-49	9"	4	78	135571
12-AR-51	12"	4	114	135572
15-AR-51	15"	5	117	135573
18-AR-51	18"	6	145	135574
24-AR-51	24"	8	210	135575
30-AR-51	30"	10	225	135576
36-AR-51	36"	12	295	135577







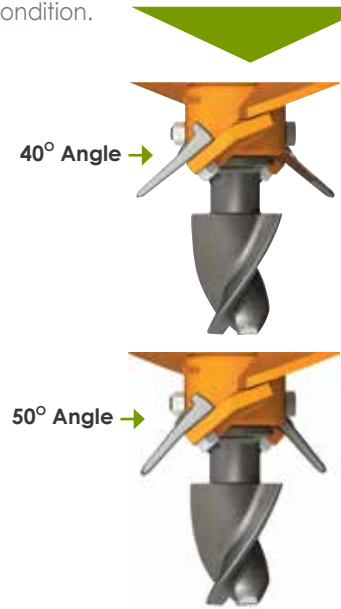

















The Aggressor<sup>®</sup> Auger item numbers above are for standard augers only. These augers will be shipped with standard teeth and pilot. You may order additional upgraded wear parts to enhance the drilling capabilities of your auger.

## AGGRESSOR<sup>®</sup>

AGGRESSOR<sup>®</sup> auger teeth are for use in dirt, abrasive soil or fractureable rock, depending on the type of tooth you are using. All types of the 40/50 tooth can be used at either a 40° or 50° angle providing different attack angles based on your drilling condition.



### PARTS | TriFlow<sup>®</sup> Pilot Bits

    	    	    	    	    
<p><b>TF-350</b></p> <p>LBS   5</p> <p>PN   135088</p>	<p><b>TF-350HF</b></p> <p>LBS   5.5</p> <p>PN   135089</p>	<p><b>TF-350CXC</b></p> <p>LBS   5.8</p> <p>PN   135091</p>	<p><b>TF-350HFTC</b></p> <p>LBS   5.5</p> <p>PN   135092</p>	<p><b>TF-350C</b></p> <p>LBS   5.5</p> <p>PN   135090</p>

### PARTS | Teeth

  	  	  
<p><b>40/50 Tooth</b></p> <p>LBS   .5</p> <p>PN   134501</p>	<p><b>40/50HFF Tooth</b></p> <p>LBS   .5</p> <p>PN   134802</p>	<p><b>40/50C Tooth</b></p> <p>LBS   .65</p> <p>PN   134519</p>

#### THE NUTS & BOLTS:

for 40/50 Teeth  
 Carriage Bolt PN 134677  
 Hex Nut Lock PN 134527

for TriFlow 350 Pilot Bits  
 3.5" Hex Bolt (6"-9" dia.) PN 174447  
 4" Hex Bolt (12" plus dia.) PN 174448  
 Hex Nut Lock PN 134527



## GENERAL PURPOSE AUGERS

# BoRH<sup>®</sup> for AGGRESSOR



Use with Revolution Series Drives: DS-2 and DS-3

The Bolt on Rock Head received its patent in June 2010.

# BoRH<sup>®</sup>

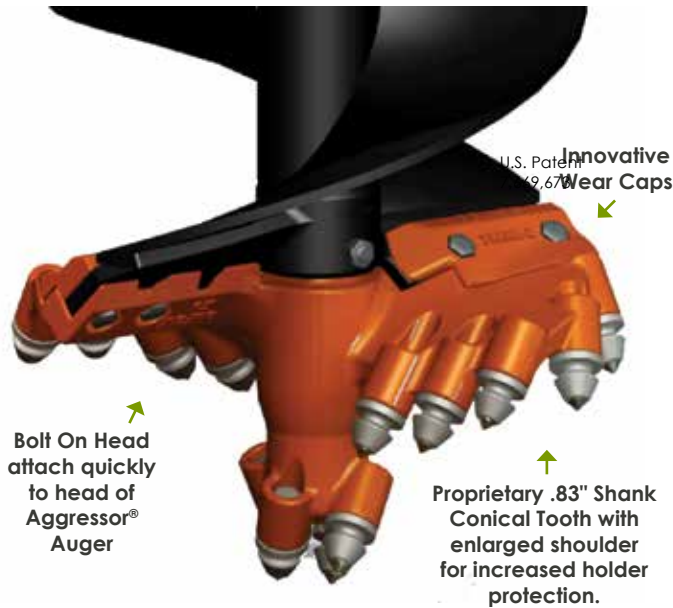

Bolt On Head attach quickly to head of Aggressor<sup>®</sup> Auger

Proprietary .83" Shank Conical Tooth with enlarged shoulder for increased holder protection.

### Easy as 1-2-3!

Use the C123 Puller for easy removal of the P21 RR tooth.



**P21 RR**

**LBS | .56**

**PN | 137990**

**C123 Puller**

**LBS | 3**

**PN | 134091**

ITEM	DIA	No. Teeth	LBS.	PN
6-BORH	6"	8	24	137991
9-BORH	9"	10	36	137992
12-BORH	12"	12	43	137993
15-BORH	15"	14	47	137994
18-BORH	18"	16	62	137995
24-BORH	24"	20	79	137996

### CONNECTIONS

### AUGER DIAMETERS

6" 9" 12" 15" 18" 24"

### CUT DIAMETER

Cut diameter is 1 1/2" larger than auger diameter.

### DRILLING SOIL CONDITIONS:

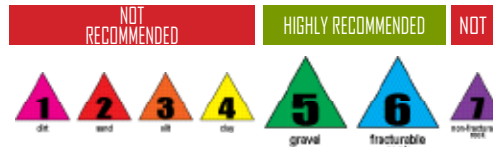

Pengo's patented BORH (Bolt on Rock Head) provides the ultimate solution for all your drilling applications. Designed to convert a standard Aggressor<sup>®</sup> Dirt Auger into a rock auger, the BORH<sup>®</sup> eliminates the need for an additional and dedicated Rock Auger. The BORH<sup>®</sup> kit contains our boring head, pilot bit, wear caps, bullet-style carbide teeth and all hardware needed to complete the installation. Featuring innovative wear caps and enlarged shoulders on the teeth for increased wear, the BORH<sup>®</sup> system provides the ultimate solution across a wide variety of soil conditions.

# AGGRESSOR<sup>®</sup> TREE AUGER



Use with Revolution Series Drives: DS-2 and DS-3

51" OAL

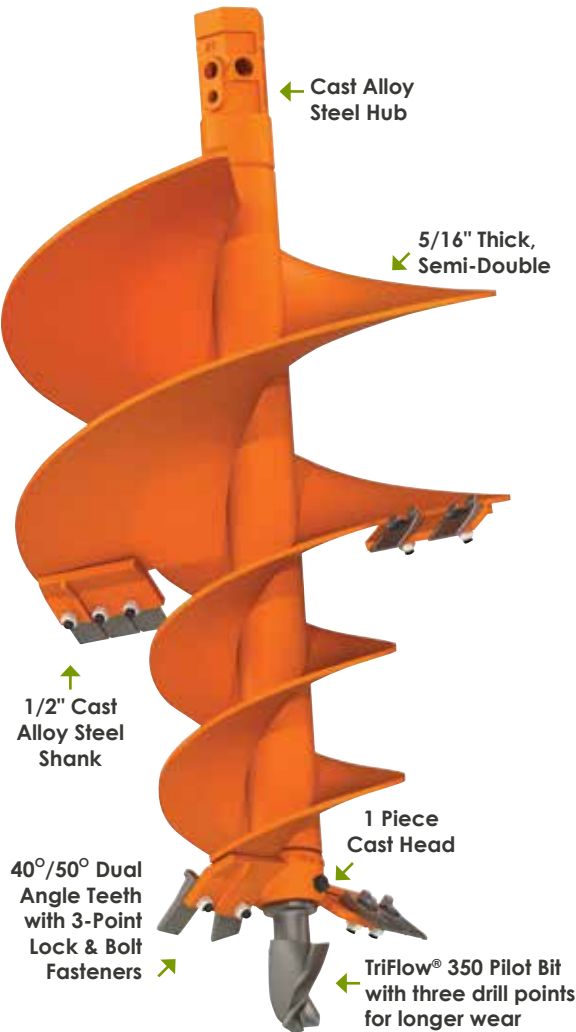

**CONNECTIONS**

ROUND 2" 2 9/16"

HEX 2"

**AUGER DIAMETERS**

6" 9" 12" 15" 18" 24" 30" 36"

**CUT DIAMETER**  
Cut diameter is 1 1/2" larger than auger diameter.

**DRILLING SOIL CONDITIONS:**



2 9/16" ROUND

ITEM	DIA	NO. TEETH	LBS	PN
918-AR-51	9/18"	8	81	135542
1224-AR-51	12/24"	9	88	135543
1530-AR-51	15/30"	11	92	135544
1836-AR-51	18/36"	13	97	135545

2" HEX

918-AR-51	9/18"	8	81	135554
1224-AR-51	12/24"	9	88	135555
1530-AR-51	15/30"	11	92	135556
1836-AR-51	18/36"	13	97	135557
24/42-AR-51	24/42"	15	112	102375

2" ROUND

918-AR-51	9/18"	8	81	135578
1224-AR-51	12/24"	9	88	135579
1530-AR-51	15/30"	11	92	135580
1836-AR-51	18/36"	13	97	135581

Pengo's Aggressor<sup>®</sup> tree auger is a more robust version of our Landscape Aggressor<sup>®</sup> Tree Auger and made specifically for high-duty cycle applications. Offering the same two-stage design that produces a tailored fit for the root ball, the Aggressor<sup>®</sup> also offers the options of a 2" hex connection and the ability to change the pilot and teeth to accommodate light rock and permafrost soil conditions.

# GENERAL PURPOSE AUGERS

## TRIMAX<sup>®</sup> AUGER



Use with Revolution Series Drives: DS-2, DS-3 and DT-5

42", 48" and 60" OAL

### SINGLE vs. DOUBLE:

The TriMax<sup>®</sup> auger is available with either single or double flight. Single flight is great for clay while double flighted augers give extra capacity and compacts loose soil on the flights.



Double Flight Auger ↓

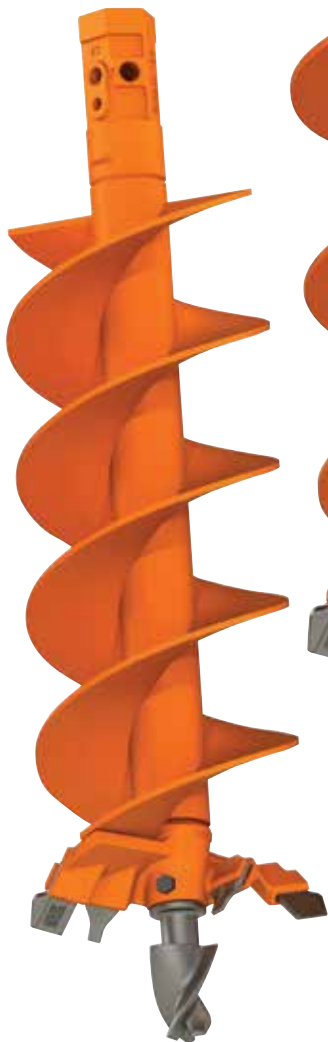

# TRIMAX

### CONNECTIONS



### AUGER DIAMETERS



### CUT DIAMETER

Cut diameter is 1 1/2" larger than auger diameter.

### DRILLING SOIL CONDITIONS:



Pengo's TriMax<sup>®</sup> auger is designed to handle your most challenging applications across a variety of drilling conditions. Available in both single and double flight configurations, the TriMax<sup>®</sup> features our TriFlow<sup>®</sup> Pilot, which provides unmatched stability and wear characteristics. Combined with our Fas-N-Lok<sup>®</sup> teeth and cast head with compound angles; dirt, sand, silt or gravel are no match for the TriMax<sup>®</sup>.

## GENERAL PURPOSE AUGERS

# TRIMAX<sup>®</sup> AUGER



### PARTS | Pilot Bits

TF-350		5	135088
TF-350C		5.5	135090
TF-350CXC		5.8	135091
TF-35HF		5.5	135089
TF-350HFTC		5.8	135092

TF-350 Pilot Bit Assembly (includes nut and bolt) PN 137325

Pengo Pilots and Teeth are rated for drilling conditions that may or may not be applicable to your power source. Refer to the soil chart listed on page 2 of this catalog to determine which tooth type is right for the job.

### TRIFLOW

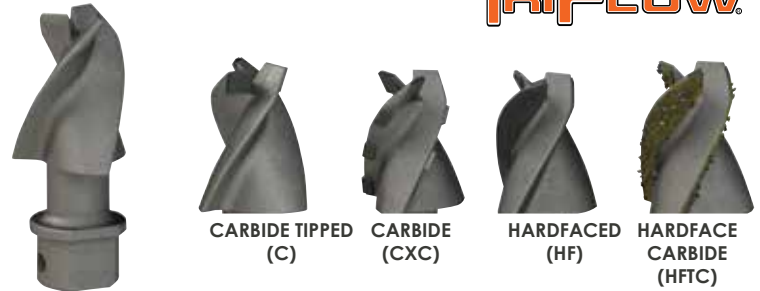

Don't Forget the Nuts & Bolts!



3.5" Hex Bolt (6"-9" dia.)  
PN 174447

4" Hex Bolt (12" plus dia.)  
PN 174448

Hex Nut Lock  
PN 134527

### PARTS | Teeth

35		.4 LBS	PN 133835
5T30		.4 LBS	PN 140029
35 HF		.6 LBS	PN 140008
35 HFF		.6 LBS	PN 140009
5T30 HF		.4 LBS	PN 140014
35 C		.4 LBS	PN 140007
5T30 C		.4 LBS	PN 140012
1336L C		.6 LBS	PN 140016
RB-5T30		.4 LBS	PN 140013
RB-36LC		.6 LBS	PN 140021

### FAS-N-LOK



### PARTS | Holders

#### T-35 HOLDER

LBS | 1

PN | 171221



#### T-36 HOLDER

LBS | 1

PN | 171231

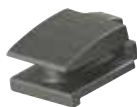

### ACCESSORIES

#### SOFT HAMMER

LBS | 3.5

PN | 137737

For Easy Installation of Fas-N-Lok<sup>®</sup> Teeth Use a soft hammer to prevent breaking of tips.

#### DRIFT PUNCH

LBS | 1

PN | 137750

For Easy Removal of Teeth Use this Drift Punch



# TRIMAX

## GENERAL PURPOSE AUGERS

# TRIMAX<sup>®</sup> AUGER



### AUGERS | 42" Overall Length, Single Flight



ITEM	DIA	NO. TEETH	LBS	2" HEX PN	2 9/16" ROUND PN	2" ROUND PN
6-TM-42 S	6"	2	46	101318	552940	101324
8-TM-42 S	8"	4	55	101319	553071	CALL
9-TM-42 S	9"	4	59	552960	553072	101325
10-TM-42 S	10"	4	66	552962	553073	CALL
12-TM-42 S	12"	4	76	552964	553074	101326
14-TM-42 S	14"	6	91	552966	553075	CALL
16-TM-42 S	16"	6	97	552968	553076	CALL
18-TM-42 S	18"	6	112	552970	553077	CALL
20-TM-42 S	20"	6	117	552972	553078	CALL
24-TM-42 S	24"	8	151	552974	553079	CALL
30-TM-42 S	30"	10	168	101320	553080	CALL
36-TM-42 S	36"	12	270	101321	553081	CALL
42-TM-42 S	42"	15	302	101322	553082	CALL
48-TM-42 S	48"	18	380	101323	553083	CALL

All Teeth numbers listed above include two 37 Gage outside teeth.

### AUGERS | 42" Overall Length, Double Flight

ITEM	DIA	NO. TEETH	LBS	2" HEX PN	2 9/16" ROUND PN	2" ROUND PN
6-TM-42 D	6"	2	52	101327	553464	CALL
8-TM-42 D	8"	4	59	101328	553465	CALL
9-TM-42 D	9"	4	74	101329	553466	CALL
10-TM-42 D	10"	4	77	101330	553467	CALL
12-TM-42 D	12"	4	88	101331	553468	CALL
14-TM-42 D	14"	6	102	101332	553469	CALL
16-TM-42 D	16"	6	116	101333	553470	CALL
18-TM-42 D	18"	6	129	101334	553471	CALL
20-TM-42 D	20"	6	135	101335	553472	CALL
24-TM-42 D	24"	8	156	101336	553473	CALL
30-TM-42 D	30"	10	173	101337	553474	CALL
36-TM-42 D	36"	12	284	101338	553475	CALL
42-TM-42 D	42"	15	343	101339	553476	CALL
48-TM-42 D	48"	18	406	102133	CALL	CALL

All Teeth numbers listed above include two 37 Gage outside teeth.

Call for 60" TriMax<sup>®</sup> part numbers. Special Orders Available upon request.  
Special orders are non-cancelable.

# TRIMAX

## GENERAL PURPOSE AUGERS

# TRIMAX<sup>®</sup> AUGER



### AUGERS | 48" Overall Length, Single Flight

ITEM	DIA	NO. TEETH	LBS	2" HEX PN	2 9/16" ROUND PN	2" ROUND PN
6-TM-48 S	6"	2	49	101340	553090	101519
8-TM-48 S	8"	4	58	101341	553091	101700
9-TM-48 S	9"	4	62	101342	553092	101520
10-TM-48 S	10"	4	69	101343	553093	102045
12-TM-48 S	12"	4	79	101344	553094	101521
14-TM-48 S	14"	6	94	101345	553095	102122
16-TM-48 S	16"	6	100	101346	553096	CALL
18-TM-48 S	18"	6	115	101347	553097	102046
20-TM-48 S	20"	6	120	101348	553098	CALL
24-TM-48 S	24"	8	153	101349	553099	102047
30-TM-48 S	30"	10	171	101350	553100	CALL
36-TM-48 S	36"	12	273	101351	553101	CALL
48-TM-48 S	42"	15	305	101352	553102	CALL
48-TM-48 S	48"	18		101353	553103	CALL

All Teeth numbers listed above include two 37 Gage outside teeth.

### AUGERS | 48" Overall Length, Double Flight

ITEM	DIA	NO. TEETH	LBS	2" HEX PN	2 9/16" ROUND PN	2" ROUND PN
6-TM-48 D	6"	2	58	101354	553480	101612
8-TM-48 D	8"	4	65	101355	553481	101613
9-TM-48 D	9"	4	80	101356	553482	CALL
10-TM-48 D	10"	4	83	101357	553483	102103
12-TM-48 D	12"	4	94	101358	553484	101617
14-TM-48 D	14"	6	108	101359	553485	102130
16-TM-48 D	16"	6	122	101360	553486	CALL
18-TM-48 D	18"	6	135	101361	553487	CALL
20-TM-48 D	20"	6	140	101362	553488	CALL
24-TM-48 D	24"	8	162	101363	553489	CALL
30-TM-48 D	30"	10	180	101364	553490	CALL
36-TM-48 D	36"	12	293	101365	553491	CALL
48-TM-48 D	42"	15	355	101366	553492	CALL
48-TM-48 D	48"	18		101367	553493	CALL

All Teeth numbers listed above include two 37 Gage outside teeth.

Call for 60" TriMax<sup>®</sup> part numbers. Special Orders Available upon request. Special orders are non-cancelable.



# TRIMAX



# STEP ROCK AUGER



Use with Revolution Series Drives: DS-2, DS-3 and DT-5

42" OAL

**CONNECTIONS**

HEX **2"**

**AUGER DIAMETERS**

6" 8" 9" 10" 12" 16" 18" 24"

**CUT DIAMETER**

Cut diameter is 1 1/2" larger than auger diameter.

**DRILLING SOIL CONDITIONS:**



Cast Alloy Steel  
2" Hex Hub →

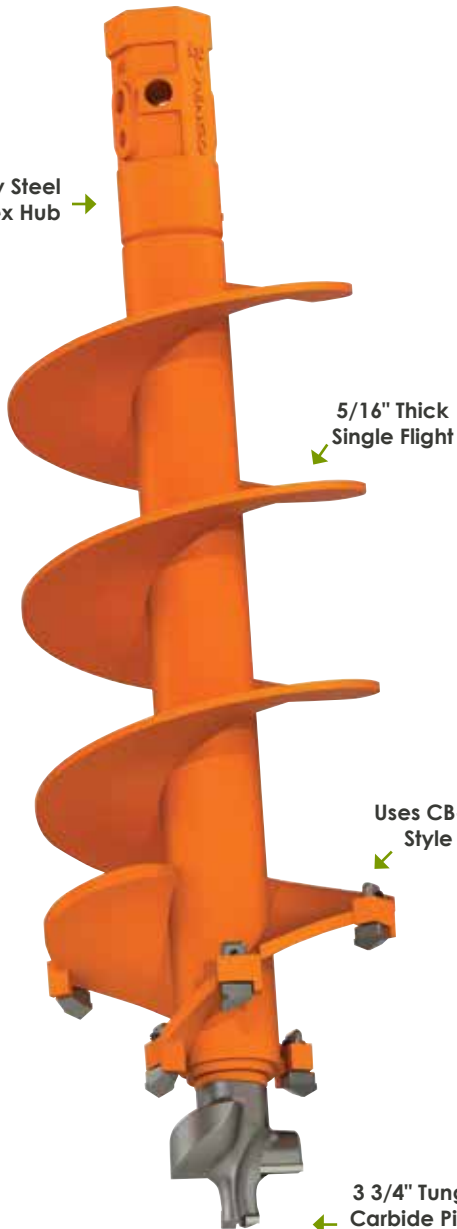

5/16" Thick  
Single Flight

Uses CB-10 Drag  
Style Teeth

3 3/4" Tungsten  
Carbide Pilot Bit  
375-TCH-M



Pengo's General Purpose Step Rock Auger is the perfect tool for compacted or frozen soil or when you need to overcome fractureable rock applications. Featuring drag style carbide teeth and a tungsten carbide pilot bit, our TCH series Pilot Bit is designed with increased carbide coverage to provide greater longevity and increased drilling efficiency.

# STEP ROCK AUGER



## AUGERS | 42" OAL

2" HEX	ITEM	DIA	NO. TEETH	LBS	PN
	6-GPSRA-42	6"	4	50	553443
	8-GPSRA-42	8"	4	56	553444
	9-GPSRA-42	9"	4	65	553442
	10-GPSRA-42	10"	5	69	553446
	12-GPSRA-42	12"	6	80	553447
	16-GPSRA-42	16"	8	110	553449
	18-GPSRA-42	18"	9	125	553450
	24-GPSRA-42	24"	12	150	553452



## PARTS | Pilot Bits



375-TCH-M Pilot
LBS   5.1
PN   132173

**THE NUTS & BOLTS:**  
Included with the 375-TCH-M Pilot Bit.

141R Drive Lug
for use with 375-TCH-M Pilot
LBS   1
PN   151956



## PARTS | Teeth



CB-10 Drag Tooth
LBS   .78
PN   140055

H-10 Holder
Use with CB-10 Tooth
LBS   .3
PN   157024

P-10 ROLL PIN
Use with CB-10 Tooth to secure tooth to shank. 6mm X 20mm
LBS   .1
PN   137610

# SEVERE ROCK RIPPER<sup>®</sup> AUGER



Use with Revolution Series Drives: DS-2, DS-3 and DT-5

42" and 48" OAL

**FACT:** The SRR Auger comes standard with the S-RL08 conical teeth. Replace with SR-76SW Strata<sup>®</sup> conical teeth for increased performance and life-cycle.

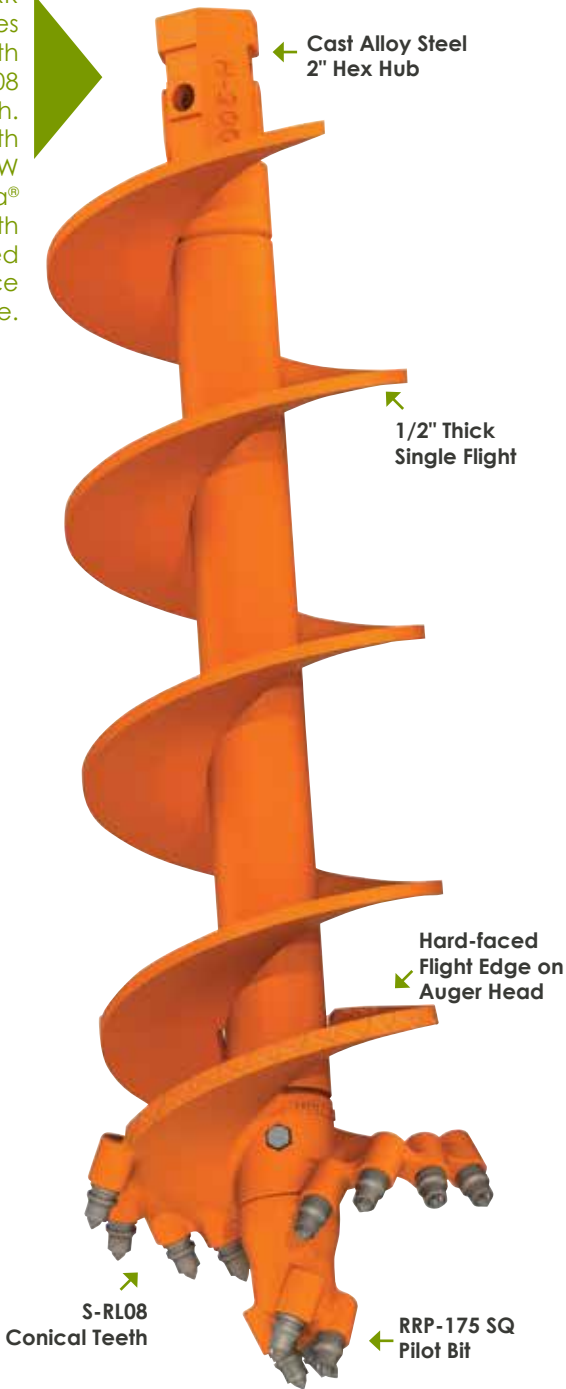

**CONNECTIONS**



**AUGER DIAMETERS**

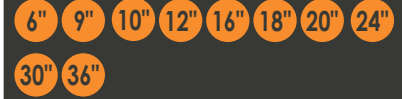

**CUT DIAMETER**

Cut diameter is 1 1/2" larger than auger diameter.

**DRILLING SOIL CONDITIONS:**



Pengo's Severe Rock Ripper<sup>®</sup> (SRR) is specifically designed to handle the most difficult rock applications. Featuring our Rock Ripper<sup>®</sup> Pilot, 1/2" thick hard faced flighting, and carbide conical teeth; the SRR is the most robust tool in the GP line-up. Our SRR can also be equipped with our Strata series of teeth, which provides drilling grade carbide and maximizes both performance and drilling efficiencies.



# GENERAL PURPOSE AUGERS

## SRR<sup>®</sup> AUGER



### AUGERS | 48" OAL

42" OAL

48" OAL

2" HEX

ITEM	DIA	NO. TEETH	LBS	PN
6-SRR	6"	8		157440
9-SRR	8"	10		157441
10-SRR	10"	10		157449
12-SRR	12"	12		157443
14-SRR	14"	14		157444
16-SRR	16"	15		157445
18-SRR	18"	16		157446
20-SRR	20"	17		157447
24-SRR	24"	20		157448
30-SRR	30"	24		CALL
36-SRR	36"	26		CALL

LBS	PN
80	137950
108	137951
	CALL
135	137952
	CALL
170	137953
192	137954
220	137955
285	137956
345	137957
415	137958

### PARTS | Pilot Bits



**RRP 1.75 SQ**  
**LBS | 15**  
**PN | 137208**  
 Use 1.75SQ Adapter **PN | 137203**



**RRP-API**  
**LBS | 18**  
**PN | 157406**

#### THE NUTS & BOLTS:

Included with the RRP 1.75 SQ Pilot.

When purchased individually, this pilot ships with four Strata<sup>®</sup> SR-76SW conical teeth.



Heavy-duty Rock Drilling Pilot Bit will penetrate in your hard rock drilling conditions.

### PARTS | Conical Teeth



**S-RL08**  
 Standard Rock Tooth for hard rock applications  
**LBS | .7**  
**PN | 850032**

#### P-10 Pocket

.86 Shank pocket for PRL-08 and SR-76SW Conical Teeth

**LBS | .8**  
**PN | 990043**



### ACCESSORIES:

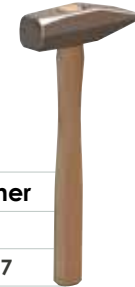

**Soft Hammer**  
**LBS | 3.5**  
**PN | 137737**

STRATA<sup>®</sup> Conical teeth are made with a fragile carbide tip. Pengo<sup>®</sup> strongly recommends using a Soft Hammer when installing STRATA<sup>®</sup> teeth.

Due to the enlarged shoulder of the SR-76SW Strata<sup>®</sup> Tooth, the C30 Puller is recommended to aid in removing the tooth.

#### C30 Puller

**LBS | 3**  
**PN | 134090**

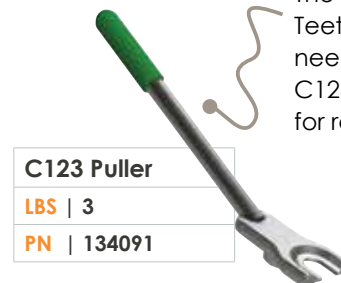

#### C123 Puller

**LBS | 3**  
**PN | 134091**

The S-RL08 Teeth will need the C123 Puller for removal.

Strata<sup>®</sup> Drilling Grade Conical Teeth were developed by Pengo for the Drilling industry. They have been proven to out-perform standard rock teeth.



#### SR-76SW

Drilling Grade Carbide Rock Tooth provides longer tooth life in extreme hard drilling conditions

**LBS | .7**  
**PN | 850035**



# GP AUGER EXTENSIONS



At times there is a need for a little more depth. Couple your Pengo auger with a Pengo extension to get the job done. We offer a wide variety of extensions from fixed to telescoping with round, square, and hex connections. Whatever your need, contact a Pengo sales team member to determine the best option for your job.

# GP AUGER EXTENSIONS

## TELESCOPING EXTENSIONS | for CS AUGERS

ITEM	DIMS	LBS	PN
G-1.00R X 24 GENERAL	1" Round x 24"		557091
G-1.375HX24 GENERAL	1.375" Hex x 24"		557092
LB-1.25SX24 LIT BEAVER	1.25 Square x 24"		557093
GH-.875SX24 GROUND HOG	.875 Square x 24"		557094
PC-1.31R X12 PENG0 COLLAR	2" Pengo Collar x 12"		557095
PC-1.687RX24 PENG0 COLLAR	2" Pengo Collar x 24"		557096
PC-1.687RX36 PENG0 COLLAR	2" Pengo Collar x 36"		557097

## TELESCOPING EXTENSIONS | for GP AUGERS

2" HEX

ITEM	DIMS	LBS	PN
HE20-12 STANDARD	H200 x 12"	22	557142
HE20-24 STANDARD	H200 x 24"	34	557143
HE20-36 STANDARD	H200 x 36"	46	557144
HE20-48 STANDARD	H200 x 48"	58	557145
HE20-60 STANDARD	H200 x 60"	69	557146
HE20-72 STANDARD	H200 x 72"	82	557147

2 9/16" ROUND

ITEM	DIMS	LBS	PN
SA24 X 256 EXT SHAFT	24" X R256	22	134668

## FIXED EXTENSIONS | for GP AUGERS

2" ROUND

ITEM	DIMS	LBS	PN
RE20-12 STD FIXED	R200 x 12"	20	557176
RE20-24 STD FIXED	R200 x 24"	31	557178
RE20-36 STD FIXED	R200 x 36"	40	557174
RE20-48 STD FIXED	R200 x 48"	50	557179
RE20-72 STD FIXED	R200 x 72"	72	557177

2 9/16" ROUND

ITEM	DIMS	LBS	PN
RE25-12 STD FIXED	R256 x 12"	20	134203
RE25-24 STD FIXED	R256 x 24"	31	134204
RE25-36 STD FIXED	R256 x 36"	40	134205
RE25-48 STD FIXED	R256 x 48"	50	134206
RE25-60 STD FIXED	R256 x 60"	61	134207
RE25-72 STD FIXED	R256 x 72"	72	134208



# GP AUGER INTERLOK<sup>®</sup> COUPLER

Innovative coupler system allows the Aggressor<sup>®</sup> auger to be equipped with three different connection sizes.



### HOW IT WORKS:

1. The Coupler is inserted into the Collar by aligning the Coupler Drive Lugs with the Collar openings located on the top ring of the Collar.
2. The Coupler is inserted into the Collar until the shoulder on the Coupler interfaces with the top of the Collar.
3. The auger coupler is rotated in a clockwise manner to engage the Coupler Lugs with the recessed areas in the Collar. "Twist and Lock".
4. Install the locking hardware. Thread the Positive Lock Pin into the Collar Ears. Positive Lock Bolts have a push button that initiates ball action and retraction.



## INTERLOK

U.S. Patent 9,127,513



A solution for dealers and customers that need to adapt auger bits to various types of auger drives.



The InterLok<sup>®</sup> system is a variable geometry auger bit coupler. The coupler allows the auger bit to utilize different coupler connections. The ability to use different connection sizes can eliminate the need for auger bit adapters. The new coupler system also allows for more universal adaptability to different types of auger drives that use various output shaft sizes and shapes.

ITEM	LBS	PN
R-200 INTERLOK HUB	5	154043
R-256 INTERLOK HUB	5	154044
H-200 INTERLOK HUB	5	154045
H-250 INTERLOK HUB	5	154046

# GP AUGER HUBS and HUB ADAPTERS

## REPLACEMENT HUBS

GP AUGERS

ITEM	DIMS	LBS	PN
R-200	2" ROUND CAST	5.2	154080
R-256U	2 9/16" UNIVERSAL	9.5	154115
H-200U	2" HEX UNIVERSAL	10.5	154121

CS AUGERS

ITEM	DIMS	LBS	PN
1" GENERAL	1" Round	1.4	153967
R-200 [PENGO]	2" Cast	5.2	154080
R-256 [ROUND]	2 9/16"	9.5	154115
7/8" GROUND HOG		.6	153964
RH-1375	1 3/8" HEX	.5	133156
RH-812	1 3/16" HEX	.6	153955
RH-1625	1 5/8" HEX	3.1	153958

HH AUGERS

ITEM	DIMS	LBS	PN
1" SQUARE [HH]	HH Auger	1	137298



## HUB ADAPTERS

FEMALE HEX

ITEM	DIMS	LBS	PN
H-200F X R256M	2" Hex Female x 2 9/16" Round Male	13	134211
H-200F X R-200M	2" Hex Female x 2" Round Male	14	557156
H-250F X H-200M	2 1/2" Hex Female x 2" Hex Male	30	132419
H-225F X H-200M	2 1/4" Hex Female x 2" Hex Male	20	557159

FEMALE ROUND

ITEM	DIMS	LBS	PN
R-200F X H-200M	2" Round Female x 2" Hex Male	13	132804
R-200F X H-225M	2" Round Female x 2 1/4" Hex Male	13	132805
R-200F X R-256M	2" Round Female x 2 9/16" Round Male	15	134210
R-256F X H-250M	2 9/16" Round Female x 2 1/2" Hex Male	21	133906
R-256F X R-200M	2 9/16" Round Female x 2" Round Male	13	132068
R-256F X S-200M	2 9/16" Round Female x 2" Square Male	19	557155
R-256XH-200M	2 9/16" Round Female x 2" Hex Male	18	557153





# GP AUGER REPLACEMENT HEADS

## CS HEADS

ITEM	DIA	NO. TEETH	LBS	PN
4-CSA	4"		3.8	553165
6-CSA	6"	1	3.3	553170
7-CSA	7"	1	3.3	553175
8-CSA	8"	2	4.5	553180
9-CSA	9"	2	4.8	553185
10-CSA	10"	2	4.8	553190
12-CSA	12"	2	5.0	553195
16-CSA	6"	5	8.9	553198
18-CSA	18"	2	9.3	553200

### CS Head Kits

The CS-Auger (CSA) Head Kits are for the replacement, repair or rebuild of your CS Auger. These kits include the SB-25 Pilot Bit Assembly, Pilot Bit Drive Lug, CS Shank and 35 Dirt Fas-N-Lok Teeth. These kits provide durable cutting to any Pengo or other branded CS auger.



## CS SHANK PLATES

ITEM	DIA	LBS	PN
6/7-CS	6"/7"	1.4	154510
8-CS	8"	2.2	154520
9/10-CS	9"/10"	2.5	154530
12-CS	12"	2.5	154540
18-CS-1	18"	2.9	154550
18-CS-2	18"	4.5	154560

### CS Shank Plates

The CS shank plates restore augers with worn tooth and holders or you may use them to upgrade any auger that has serrated edges. The shank plate welds to the underside of the augers bottom plate. This is the plate only, not teeth or pilot are included with the CS shank plate.



## CS SHANK PLATES

ITEM	DIA	LBS	PN
6-SC-CSA	6"	1.4	153300
7-SC-CSA	7"	1.6	153301
8-SC-CSA	8"	2.8	153302
9-SC-CSA	9"	3.2	153303
10-SC-CSA	10"	4.3	153304
12-SC-CSA	12"	5.9	153305

### CS Head Plates

The CS head plates will upgrade any brand of auger. Use the head plate for repair or rebuild of any CS auger.



# GP AUGER REPLACEMENT HEADS

## AGGRESSOR® HEADS

ITEM	DIA	LBS	PN
HEAD AUG [6-AR] CAST	6"	3.4	137692
HEAD AUG [9-AR] CAST	9"	5	137693
HEAD AUG [12-AR] CAST	12"	8	137694
HEAD AUG [15-AR] CAST	15"	9.3	137695
HEAD AUG [18-AR] CAST	18"	10.1	137696
HEAD AUG [24-AR] CAST	24"	12.6	137697



## AGGRESSOR®

Use the Pengo Aggressor Cast heads to replace or repair your current auger. Simply remove the teeth and pilot and follow the instructions below.

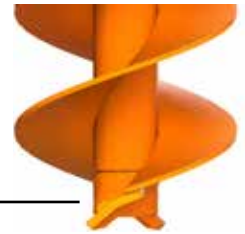

There must be at least 2" of clearance between weld seam and front edge of shank.



**STEP 1**  
Torch off old shanks and pilot adapter, angle torch to remove shanks from bottom side of flight. Leave as much flight as possible.



**STEP 2**  
Grind flight edges. Flight edges should be parallel and in-line with each other.

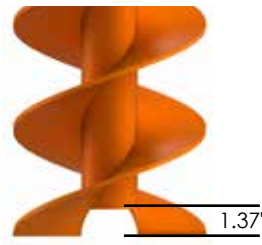

**STEP 3**  
Torch and grind out center shaft flush. End of flight should be approximately 1 3/8" beyond end of center shaft.

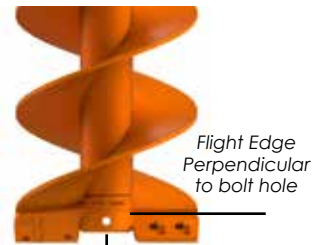

**STEP 4**  
Install cast head and weld all around.

Flight Edge Perpendicular to bolt hole

## TRIMAX® HEADS

ITEM	DIA	NO. TEETH	LBS	PN
TMOBH-6	6"	2	12	135813
TMOBH-8	8"	4	17	135814
TMOBH-9	9"	4	18	135815
TMOBH-10	10"	4	19	135816
TMOBH-12	12"	4	21	135817
TMOBH-14	14"	6	22	135818
TMOBH-16	16"	6	24	135819
TMOBH-18	18"	6	25	135820
TMOBH-20	20"	6	27	135821
TMOBH-24	24"	8	32	135822
TMOBH-30	30"	10	40	135823
TMOBH-36	36"	12	48	135824
TMOBH-42	42"	16	48	135825
TMOBH-48	48"	18	48	135826

For those who want to build their own auger or simply repair an auger, we offer the ever popular TriMax® Weld-On Boring Heads. These heads feature the patented TriFlow® bit and Fas-N-Lok® dirt teeth, 37 Gage on the outside and 5T30 Carbide on the inside.

Once you weld on the TriMax® head to any auger flight of equal diameter you will have the ability to drill in dirt, clay, and light rock.

Each TriMax® Boring Head kit contains the boring head, pilot bit, teeth and hardware.

## TRIMAX®

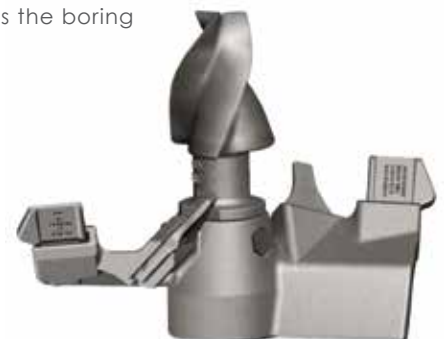

# GP AUGER DRIVE CS-1



SINGLE SPEED DRIVE UNIT | PN 623010

use Pengo Aggressor® TriMax® Severe Rock Ripper® Augers

**REFERENCE SPEED CHART**

Flow GPM (Liter)	Theoretical
5	26
10	52
15	78

**REFERENCE TORQUE CHART**

Pressure (psi)	THEORETICAL Torque (ft/lb)
1200	709
1400	828
1600	946
1800	1064
2000	1183
2200	1301
2400	1419
2600	1538
2800	1656
3000	1774

Speed and torque specifications are based on theoretical values and are provided for comparative purposes only.

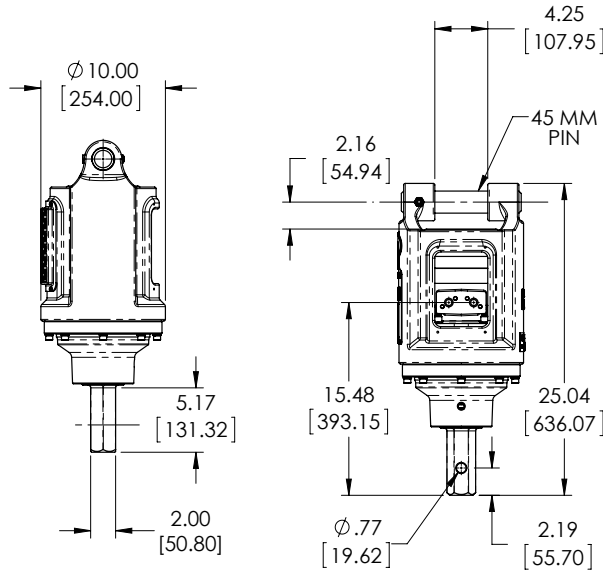

**45MM Link Arm**

LBS | 7

PN | 623064



**45MM Pin**

LBS | 1

PN | 620024



**Does Not Require a Case Drain**

Lightweight and compact



Protective Vents Allow for Hydraulic Motor Cooling

2" Hex Output Shaft

## MOUNT for CS-1

This CS-1 Drive and Mount are sold as a unit. Couple your Aggressor®, TriMax® or Severe Rock Ripper® with this unit for a complete General Purpose drive package.



**CS-1 Drive and Mount**

LBS | 300

PN | 623066

**HYDRAULIC MOTOR INFORMATION**

Displacement	12.1 cu/in (198cc)
Motor Type	Single Speed Bi-Directional
Motor Output Shaft	1 1/4" Spline 14T
Motor Mount	SAE - A 2 Bolt
Motor Ports	7/8-14 UNF-2B O-Ring
Cross Over Pressure Relief	NA

**PLANETARY GEARBOX INFORMATION**

Gearbox Type	Planetary Single Stage
Reduction Ratio	3.69:1
Output Shaft	2" Hex
Internal Oil Capacity	25 oz.

**GENERAL INFORMATION**

Min/Max Flow (gpm)	5/15
Max Pressure (psi)	3000
Max Dia. Auger Bit	24"
Weight	130 lbs.

# GP AUGER DRIVE CS-2



SINGLE SPEED DRIVE UNIT | PN 623011

use Pengo Aggressor® TriMax® Severe Rock Ripper® Augers

## Does Not Require a Case Drain

Lightweight  
and  
compact



Protective Vents Allow for Hydraulic Motor Cooling

2" Hex Output Shaft

REFERENCE SPEED CHART	
Flow GPM (Liter)	RPM
10	41
15	61
20	81
25	102

REFERENCE TORQUE CHART	
Pressure (psi)	THEORETICAL Torque (ft/lb)
1200	903
1400	1054
1600	1204
1800	1355
2000	1505
2200	1656
2400	1807
2600	1957
2800	2108
3000	2258

Speed and torque specifications are based on theoretical values and are provided for comparative purposes only.

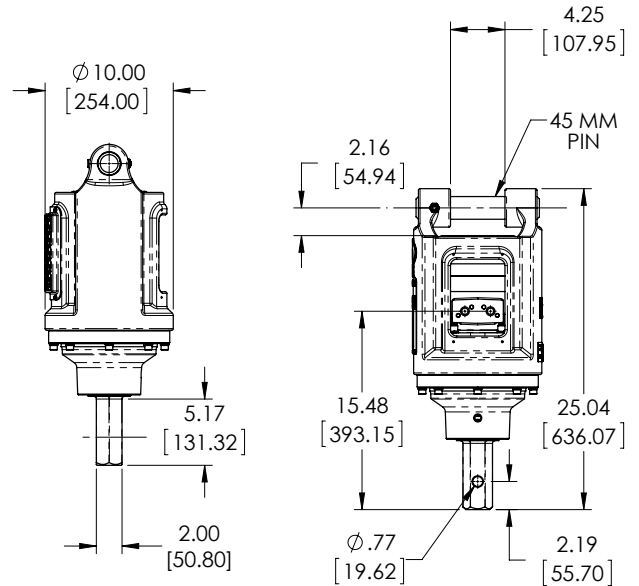

### 45MM Link Arm

LBS | 7

PN | 623064



### 45MM Pin

LBS | 1

PN | 620024



### HYDRAULIC MOTOR INFORMATION

Displacement	15.4 cu/in (252cc)
Motor Type	Single Speed Bi-Directional
Motor Output Shaft	1 1/4" Spline 14T
Motor Mount	SAE - A 2 Bolt
Motor Ports	7/8-14 UNF-2B O-Ring
Cross Over Pressure Relief	NA

### PLANETARY GEARBOX INFORMATION

Gearbox Type	Planetary Single Stage
Reduction Ratio	3.69:1
Output Shaft	2" Hex
Internal Oil Capacity	25 oz.

### GENERAL INFORMATION

Min/Max Flow (gpm)	5/25
Max Pressure (psi)	3000
Max Dia. Auger Bit	30"
Weight	130 lbs.

## MOUNT for CS-2

This CS-2 Drive and Mount are sold as a unit. Couple your Aggressor®, TriMax® or Severe Rock Ripper® with this unit for a complete General Purpose drive package.

### CS-2 Drive and Mount

LBS | 300

PN | 623067



# GP AUGER DRIVE CS-3



SINGLE SPEED DRIVE UNIT | PN 623012

use Pengo Aggressor® TriMax® Severe Rock Ripper® Augers

**Does Not Require a Case Drain**

Lightweight and compact

Protective Vents Allow for Hydraulic Motor Cooling

2" Hex Output Shaft



**REFERENCE SPEED CHART**

Flow GPM (Liter)	RPM
15	51
20	68
25	85
30	103

**REFERENCE TORQUE CHART**

Pressure (psi)	THEORETICAL Torque (ft/lb)
1200	1075
1400	1254
1600	1434
1800	1613
2000	1792
2200	1971
2400	2151
2600	2330
2800	2509
3000	2689

Speed and torque specifications are based on theoretical values and are provided for comparative purposes only.

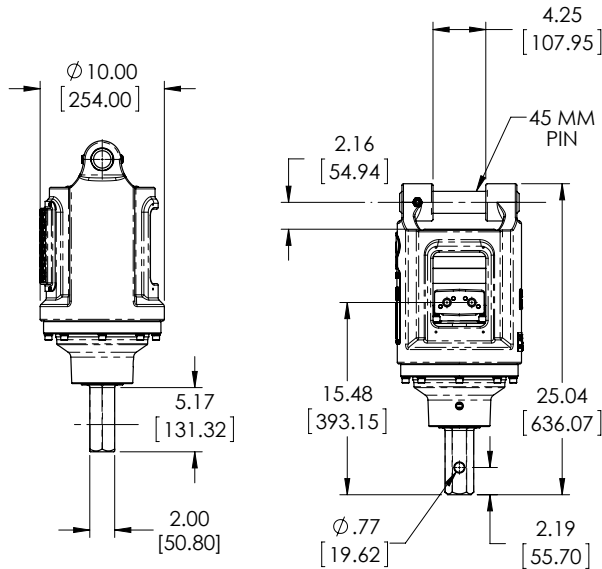

**45MM Link Arm**

LBS | 7

PN | 623064



**45MM Pin**

LBS | 1

PN | 620024



## MOUNT for CS-3

This CS-3 Drive and Mount are sold as a unit. Couple your Aggressor®, TriMax® or Severe Rock Ripper® with this unit for a complete General Purpose drive package.



**CS-3 Drive and Mount**

LBS | 300

PN | 623068

**HYDRAULIC MOTOR INFORMATION**

Displacement	18.3 cu/in (300cc)
Motor Type	Single Speed Bi-Directional
Motor Output Shaft	1 1/4" Spline 14T
Motor Mount	SAE - A 2 Bolt
Motor Ports	7/8-14 UNF-2B O-Ring

**PLANETARY GEARBOX INFORMATION**

Gearbox Type	Planetary Single Stage
Reduction Ratio	3.69:1
Output Shaft	2" Hex
Internal Oil Capacity	25 oz.

**GENERAL INFORMATION**

Min/Max Flow (gpm)	5/30
Max Pressure (psi)	3000
Max Dia. Auger Bit	36"
Weight	130 lbs.

# GP AUGER DRIVE CS-4



SINGLE SPEED DRIVE UNIT | PN 623018

use Pengo Aggressor® TriMax® Severe Rock Ripper® Augers

## Does Not Require a Case Drain

Lightweight  
and  
compact



Protective Vents Allow for Hydraulic Motor Cooling

2" Hex Output Shaft

REFERENCE SPEED CHART	
Flow GPM (Liter)	RPM
20	52
25	65
30	78
35	91

REFERENCE TORQUE CHART	
Pressure (psi)	THEORETICAL Torque (ft/lb)
1200	1416
1400	1652
1600	1888
1800	2124
2000	2360
2200	2596
2400	2832
2600	3068
2800	3304
3000	3540

Speed and torque specifications are based on theoretical values and are provided for comparative purposes only.

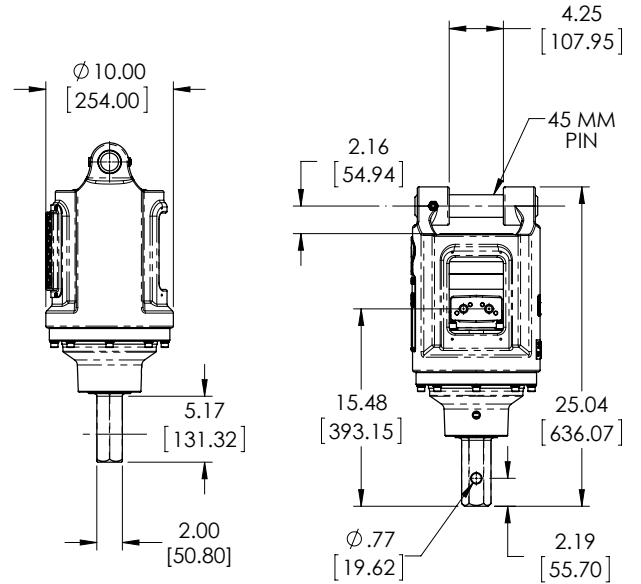

### 45MM Link Arm

LBS | 7

PN | 623064



### 45MM Pin

LBS | 1

PN | 620024



### HYDRAULIC MOTOR INFORMATION

Displacement	24.1 cu/in (395cc)
Motor Type	Single Speed Bi-Directional
Motor Output Shaft	1 1/4" Spline 14T
Motor Mount	SAE - A 2 Bolt
Motor Ports	7/8-14 UNF-2B O-Ring
Cross Over Pressure Relief	NA

### PLANETARY GEARBOX INFORMATION

Gearbox Type	Planetary Single Stage
Reduction Ratio	3.69:1
Output Shaft	2" Hex
Internal Oil Capacity	25 oz.

### GENERAL INFORMATION

Min/Max Flow (gpm)	5/35
Max Pressure (psi)	3000
Max Dia. Auger Bit	36"
Weight	130 lbs.

## MOUNT for CS-4

This CS-4 Drive and Mount are sold as a unit. Couple your Aggressor®, TriMax® or Severe Rock Ripper® with this unit for a complete General Purpose drive package.

### CS-4 Drive and Mount

LBS | 300

PN | 623069



---

# PENGO<sup>®</sup> WARRANTY

---

## PENGO LIMITED WARRANTY

Products manufactured by Pengo wear and are expendable in their function. Wear and tear and occasional breakage must, therefore, be expected

Pengo products are warranted from defects in material and workmanship for a period of Sixty (60) Days from the date of invoice. Pengo will either replace or credit the defective part at it's option. Any labor and/or material required to remove or install parts is excluded under this Limited Warranty. Products that have been misused, misapplied, hard-faced, improperly welded, or otherwise installed contrary to instructions and specifications are not covered by this Limited Warranty.

Pengo reserves the right to make design, specification and prices changes without notice and obligations to the affect of such changes.

Pengo makes no other warranty. All other warranties, whether express, implied or statutory, such as warranties of merchantability of fitness for a particular purpose, are hereby excluded and disclaimed to the extent that they exceed the warranties expressly granted in this limited warranty. In no event shall Pengo be liable for consequential or incidental damages. Whether direct or indirect, claimed by the customer and/or any third parties.

## RETURNS AND CLAIMS

1. Pengo reserves the right to determine whether products claimed to be defective shall be inspected by our personnel in the field or returned to the factory. If judged by Pengo to be defective in material or workmanship, the product will be replaced or a credit issued at the option of Pengo.
2. Upon notification of defect, Pengo's Inside Sales Department will issue a Return Goods Authorization number (RGA). All returns for replacement or credit MUST be accompanied by a RGA number. Products returned without a RGA number will be rejected and returned to the sender freight collect.
3. All returns must be shipped "prepaid". Products shipped "collect" will be refused. Proof of purchase such as invoice number must accompany returns.
4. Slow moving dealer inventory may be returned once per calendar year. The net value cannot exceed 5% of the previous year's purchases. A 20% re-stocking charge will apply to the net value or returned products. All returns must be of current manufacture and in un-used condition. Rusty or custom painted products will not be accepted for return.

PENGO GENERAL PURPOSE AUGERS

800.599.0211

GPO33116

Division of  
**IES** | INTERNATIONAL  
EQUIPMENT  
SOLUTIONS