

Herbiflex – 4

CONTENTS	Page
Description	1
Safety.....	2
Operator protection	3
Preparing for spraying	3
Before spraying for the first time.....	4
Mixing, filling and calibration	6
To start spraying	11
To stop spraying	11
After spraying	12
Storage.....	14
Optional extras	14
Troubleshooting	15
HERBIFLEX-4 Extra	16
Parts List / diagram HERBIFLEX-4 (Basic).....	17/18
Parts List / <i>Micropak</i> 5 litre backpack and optional extras	19

DESCRIPTION

The HERBIFLEX-4 is a hand-held, shrouded, spinning disc, Controlled Droplet Application (CDA) sprayer. It is powered by four torch (D-cell/R20) batteries, with one set of good quality batteries giving over 30 hours spraying time. It is designed to apply herbicides in adjustable narrow bands of between 10 and 75 cm at low volumes (10 to 30 litres/hectare). A governed electric motor spins the atomiser disc at a constant 2,800 rpm to produce uniform spray droplets of around 200 micron; large enough to minimise any risk of spray drift. Liquid is fed by gravity through colour coded feed nozzles.

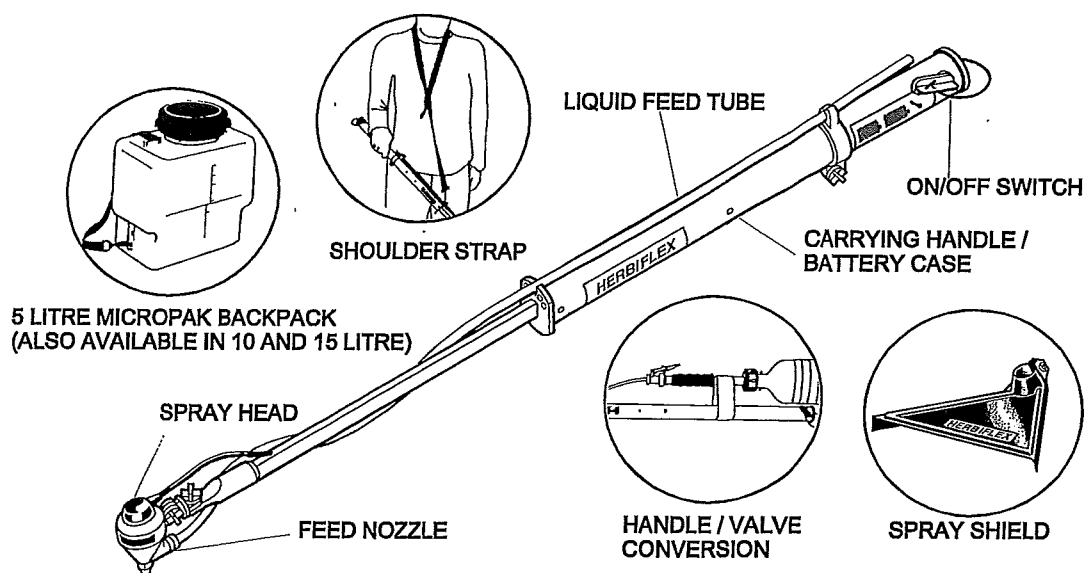

The HERBIFLEX-4 can be used to apply bands of herbicides around buildings, fence lines, borders and pathways as well as for treatment between crop rows. The weight of the machine ready to spray, with the *Micropak* 5 litre backpack, is 7 kg.

Specially designed Micron *Micropak* backpacks and a shoulder strap are available for use with the HERBIFLEX-4. Other optional extras include an atomiser cone housing (B 120) which allows a wider band to be sprayed and a spray shield (for use with the standard A90 atomiser cone housing only).

The sprayer can also be supplied with a valve/handle conversion, as the HERBIFLEX-4 Extra, which allows Micron spray bottles to be fitted directly to the sprayer.

SAFETY

Using agrochemicals is a hazardous process. Operators should comply with all relevant legislation and/or regulations governing the use of agrochemicals and should use appropriate personal protective equipment (see 'OPERATOR PROTECTION'). **Never** use the HERBIFLEX-4 in potentially explosive atmospheres or spray flammable liquid through it.

The HERBIFLEX-4 can be used with most conventional herbicides, as well as specific CDA formulations (only available in some countries) to provide a closed transfer system to improve operator safety.

Always read the product label carefully to discover:-

- ◆ approved applications
- ◆ maximum dose rates
- ◆ maximum number of treatments
- ◆ operator protection required
- ◆ necessary environmental protection measures

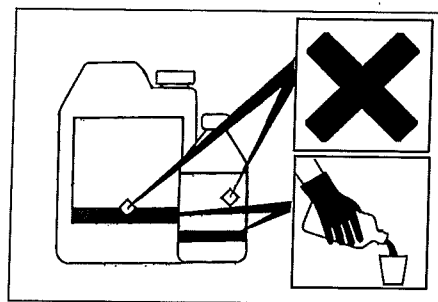

N.B. 'Dose rate' refers to the amount of chemical product applied per hectare.

Never eat, drink, or smoke when working with agrochemicals. After using agrochemicals or handling equipment wash your hands thoroughly. Keep people (especially children) and animals out of areas being sprayed.

Always store agrochemicals safely to protect people and animals, and to safeguard the environment (take special care to avoid water pollution). See spraying sections for guidelines on safe use of the HERBIFLEX-4 in operation.

OPERATOR PROTECTION

Always wear the protective clothing items listed on the product label for mixing and filling. The **minimum** protective clothing required for **spraying** with the HERBI-FLEX-4 is:

- ◆ rubber gloves and boots
- ◆ boots/shoes and long trousers
- ◆ eye protection
- ◆ long sleeved shirt



Note:

- a) Acoustic information: the sound pressure level at the operator's ear does not exceed 70 dB(A).
- b) Vibration: the weighted RMS acceleration value at the hands when using this machine does not exceed 2.5 m/sec².

PREPARING FOR SPRAYING

The sprayer is delivered in a collapsed form. To assemble ready for spraying:

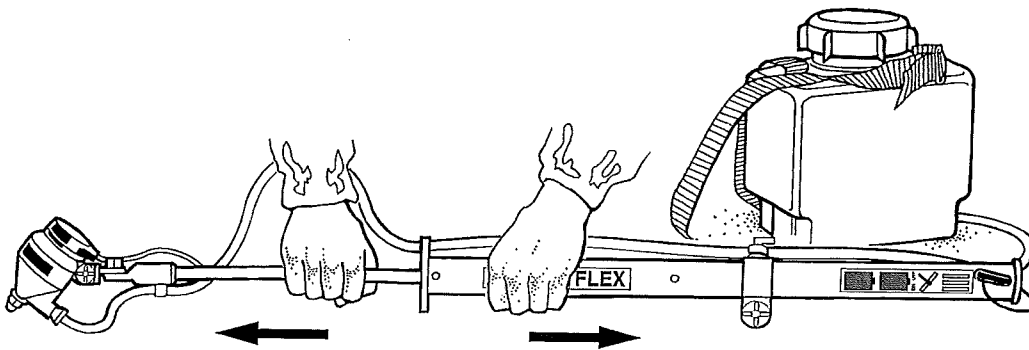

- 1) Extend the sprayer and securely connect the feed tube to the flow valve. Instructions on assembling Micron *Micropak* backpacks are contained in the tank. The shoulder strap (if supplied) should be connected to the battery case end cap.

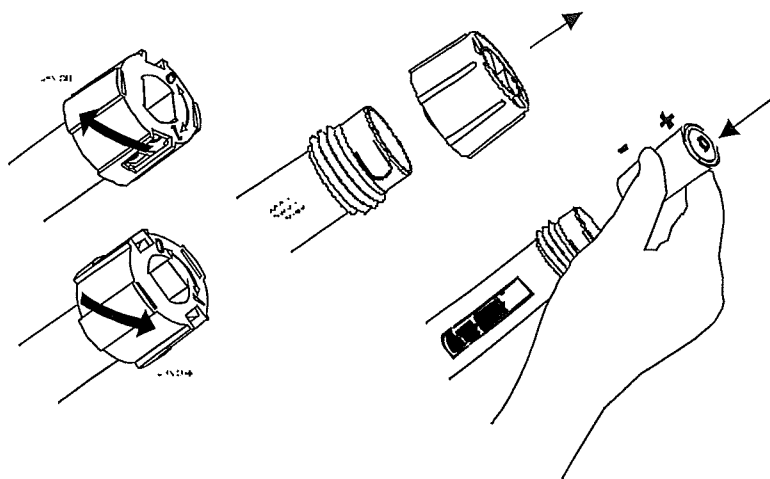

2) Remove the switch end piece as shown on the label.

3) Insert four batteries (D-cell/R20) negative, i.e. flat, end first.

BEFORE SPRAYING FOR THE FIRST TIME

Before spraying for the first time use water and liquid detergent **only** to familiarise yourself with the sprayer and check the spray pattern produced.

Put around half a litre of water in backpack or bottle and add a small amount (one to two ml) of liquid detergent such as household washing up liquid. The detergent is important to reduce the surface tension in the liquid feed tube and helps ensure an even flow. With the sprayer in the spraying position, check for leaks.

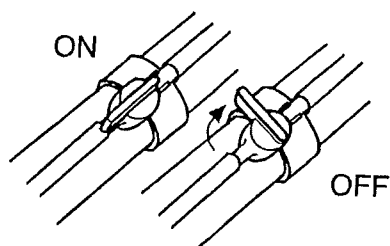

Switch on the sprayer and then open the flow control valve. Again check for leaks.

When spraying, the spray head should be held 5-7 cm above the ground or top of weed canopy with the lance at an angle of 35-40° to the ground. Spray on one spot for around 10 seconds, preferably on a clean dry surface e.g. concrete where you will be able to see the spray pattern produced.

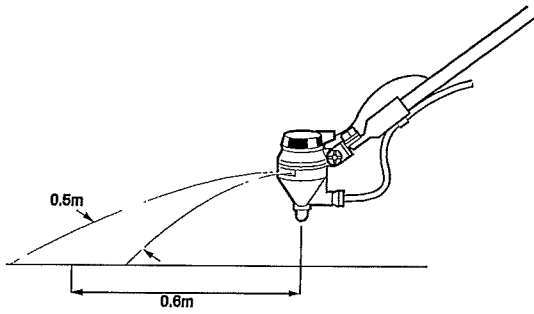

If the spray head is horizontal the spray should project forward about 0.6 m and produce a pattern or band around 0.5 m wide using the standard atomiser cone housing (A 90).

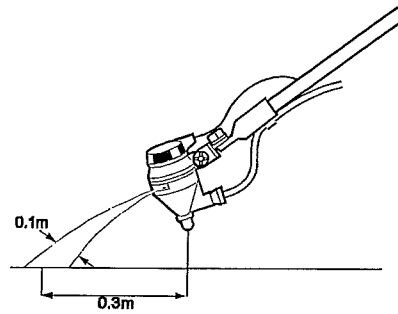

If the head is angled downwards the band width will be reduced. The angle of the spray head should not exceed 45° otherwise dripping will result.

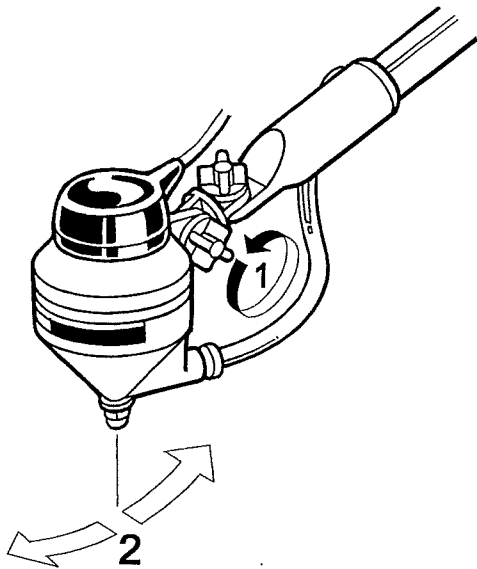

Changing the angle of the spray head will adjust the band width produced. To change the angle of the spray head slacken the vertical adjustment nut (1), alter the angle of the head (2), re-tighten the nut and check the new band width produced.

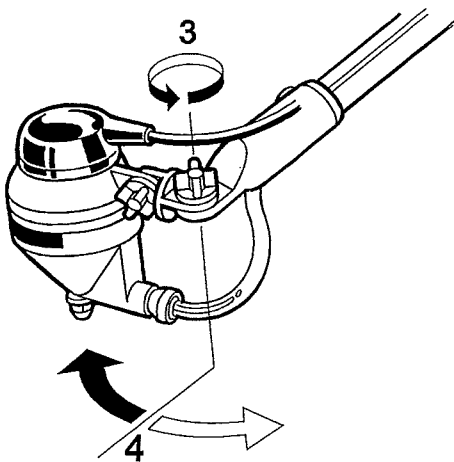

The head of the HERBIFLEX-4 can also be turned sideways in order to spray narrow lines or adjust the placement of the spray pattern produced. To do this slacken the horizontal adjustment nut (3), rotate the head (4) and re-tighten to lock the position.

MIXING, FILLING AND CALIBRATION

Mixing and filling is generally the most hazardous process in the spraying operation. **Always** follow the label instructions. **Always** use a filter (fitted in the Micron *Micropak* backpacks) and use a funnel if filling a container with a small neck. **Only** mix enough spray for the area to be treated thereby avoiding the need for disposal of unused spray mix.

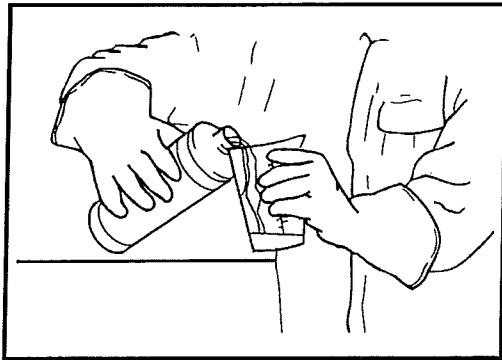

Always wear gloves when handling agrochemicals and equipment.

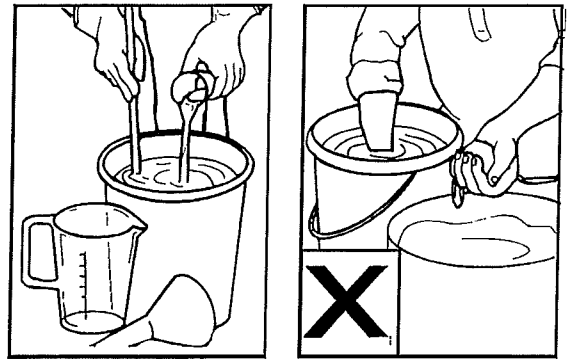

Always use the correct equipment when mixing and measuring.

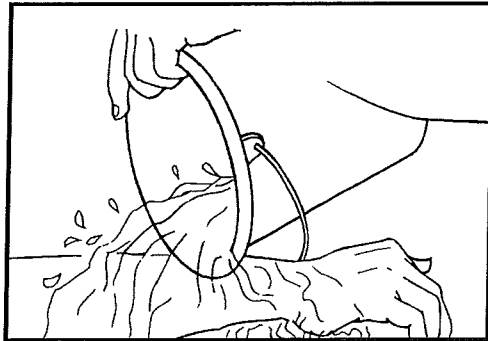

Always wash off any skin contamination

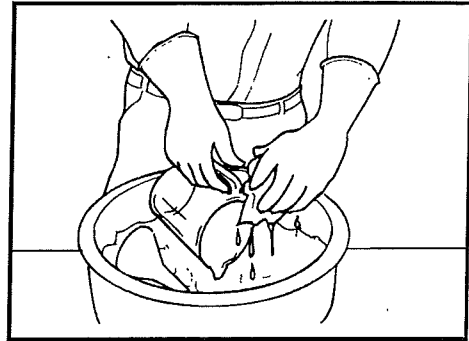

Always clean all equipment after use.

With the HERBIFLEX-4 herbicides are usually applied in around 20 litres total spray volume per hectare. The exception is glyphosate which can be applied at volumes as low as 10 litres per hectare. These are lower volumes than recommended for high volume application with knapsack sprayers. Use the minimum dose rate recommended on the label for the intended treatment and add water to make up to the volume required for application with the HERBIFLEX-4.

For example, if the label recommends applying a minimum of 2 litres of product made up to 200 litres of water per hectare with a knapsack sprayer, use 2 litres of product made up to 20 litres for application with the HERBIFLEX-4, i.e. a spray mix concentration of 10%.

Do not use herbicide concentrations greater than the maximum recommended on the label (unless specific training or recommendations have been given) if the label:

- a) specifically prohibits use of 'Reduced Volumes' i.e. increased concentrations;
- b) has a statutory requirement for use of personal protective equipment when using the diluted product at high volumes (N.B. this will appear in the statutory box on the label); or
- c) carries one of the following hazard ratings: 'very toxic', 'toxic' or 'corrosive' or carries the warning 'risk of serious damage to the eyes' e.g. paraquat (Gramoxone) which is classified as toxic should not therefore be used through the HERBIFLEX-4 at concentrations greater than recommended on the label.

Micron do not generally recommend using spray mixes more than ten times the maximum concentration recommended for high volume application with knapsack sprayers. The safest product and lowest dose rate appropriate for the treatment should be used at all times.

To prepare the spray mix first read the product label to determine the quantity of product to be applied per hectare e.g. 2 litres of glyphosate per hectare. Then determine the total spray volume to be applied per hectare with the Herbi-4 i.e. 10 or 20 litres per hectare. Calculate the ratio of product in water e.g. 2 litres glyphosate + 8 litres water = 10 litre mix = 1: 4. Use this ratio to prepare the correct dose for the spray tank or bottle e.g. with a 5 litre backpack mix 1 litre glyphosate with 4 litre of water.

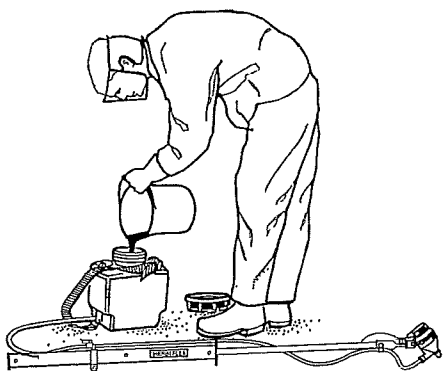

Half fill the tank with clean water and check for leaks

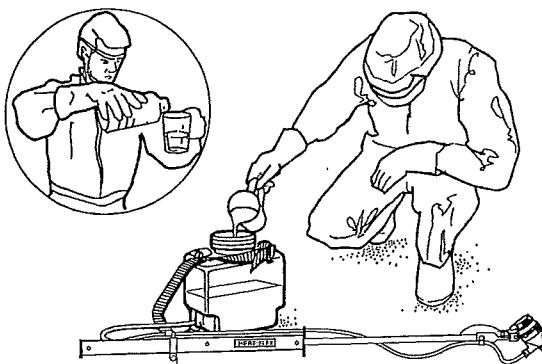

Measure out the exact amount of product and add to the tank

Never use leaking equipment. Take care to avoid spillage when filling or lifting the tank.

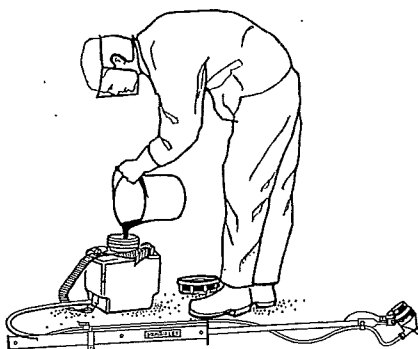

Fill the tank with water

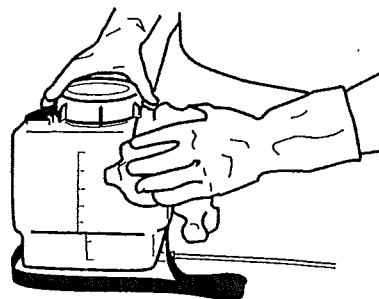

Wipe the tank with a dry cloth.

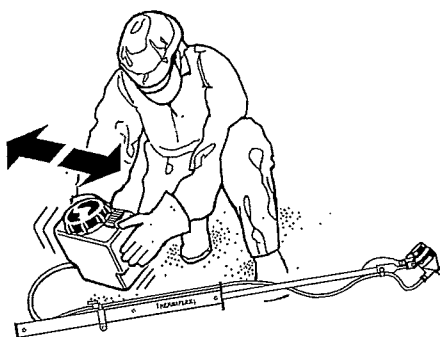

Mix well by gently shaking the tank.



Place the tank on the operator's back.

Examples of mixing spray - for 1 hectare

a) glyphosate (360 g/l):	2 litres
add water:	+8 litres
Total volume:	10 litres

i.e. 1 part glyphosate : 4 parts water
e.g. 1 litre of glyphosate + 4 litres of water in 5 litre tank.

b) 2,4-D (500 g/l):	3 litres
add water:	+17 litres
Total volume:	20 litres

i.e. 3 parts 2,4-D : 17 parts water
e.g. 750 ml 2,4-D + 4.25 litres in water in 5 litre tank

Never use leaking equipment. Take care to avoid spillage of the spray mix.

CALIBRATION

The formula below gives the relationship between swath (i.e. band) width, flow rate, walking speed and total spray volume:

$$\text{Flow rate (ml/min)} = 6 \times \text{total spray volume (l/ha)} \times \text{walking speed (m/s)} \times \text{band width (m)}$$

To help calibrate the HERBIFLEX-4 a calculator disc is provided with the sprayer. This is used as below:

1. Decide the total spray volume application rate to be used. A CDA rate may be indicated on the label of the product. If not, as a general guide, use 10 l/ha (total spray volume) for glyphosate and 20 l/ha (total spray volume) for other herbicides.

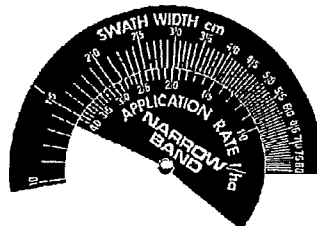
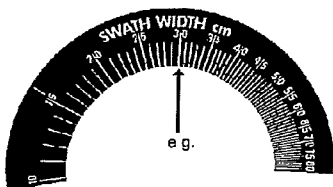

2. Decide the swath (band) width you wish to use (e.g. 30 cm) and set the angle of the head accordingly (see 'BEFORE SPRAYING FOR THE FIRST TIME').

3. On the calculator disc align the swath (band) width (in cm) with the total volume application rate (e.g. 20 l/ha) as determined in 1. above.

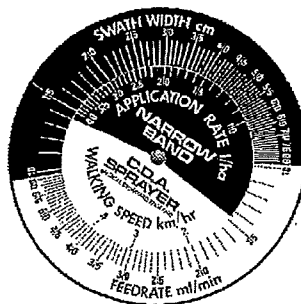
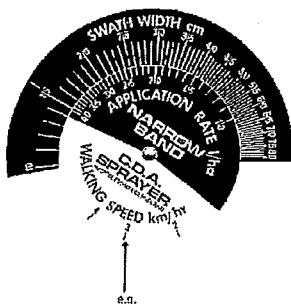







4. Having fixed the swath (band) width and volume application rate select the preferred walking speed (2km/hr = Slow, 3km/hr = Medium, 4 km/hr = Fast)·N.B. 1 m/s = 3.6 km/hr.

5. Read off the feed rate required to give the correct volume application rate. (e.g. 30 ml/min with 30 cm swath (band) width and walking speed of 3 km/hr to apply at a volume of 20 l/ha).

Unless using the atomiser cone housing B120 for wider swaths (see 'OPTIONAL EXTRAS') the flow rate used should not exceed 45 ml/min

6. Fit the feed nozzle which is likely to give this feed rate using the table below as a guide:

		Increased Flow rate 					
							
Feed nozzle		White	Brown	Blue	Yellow*	Orange*	Red*
Flow rate	Thin liquids	30	45	60*	Do not use	Do not use	Do not use
(ml/min)	Thick liquids	10-15	15-25	25-35	35-45	45-55*	55+*

(* Supplied for use with the atomiser cone housing B120 only - do not use with the atomiser cone housing A90 as this will result in flooding of the cone.)

7. Measure the flow rate which this feed nozzle gives using the actual spray liquid to be used.

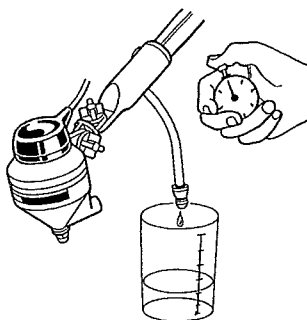

The actual flow rate should be checked holding the HERBIFLEX-4 in the spraying position (see 'TO START SPRAYING'). Remove the feed nozzle from the atomiser cone housing and allow the liquid to flow into a suitable container (such as the 50 ml measuring cup provided with the sprayer).

If the sprayer is new it may be noticed that with the white or brown feed nozzle fitted, air trapped in the liquid feed tube reduces the flow rate. If this occurs, clear the air by gently tapping the tube and, if necessary, flushing it through with a strong soap solution to reduce the surface tension in it. Once a steady flow is established measure the volume dispensed in one minute. If necessary fit a different feed nozzle and re-measure the flow rate.

Read off from the calculator the actual walking speed which is needed to apply the given volume application rate with the flow rate measured. It is preferable to walk more slowly to achieve the required spray volume than to use higher flow rates.

e.g.	Volume Application Rate (l/ha)	Band Width (cm)	Flow Rate (ml/min)	Nozzle	Walking Speed (km/hr)
Glyphosate	10	45	30	White	4
Other herbicides	20	45	45	Brown	3
	20	45	30	White	2

TO START SPRAYING

Before spraying for the first time check the operation of the sprayer using water and a little detergent only. (see 'BEFORE SPRAYING FOR THE FIRST TIME').

Check the wind speed and direction (below 5 kph is safest). Take special care to avoid drift by keeping the spray head as low as possible. **Never** spray into the wind and avoid walking into the spray.

N.B. To help aid the balance of the sprayer, while using the 2 1/2 L Bottle, a Shoulder strap is provided.

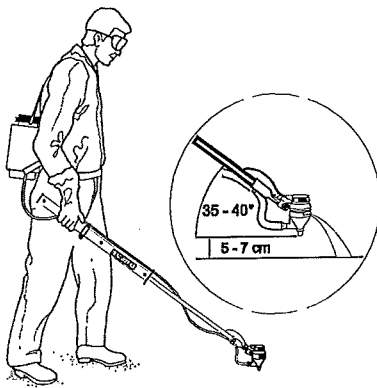

Hold the spray head 5-7 cm above the ground or weed foliage at an angle of 35° to 40° to the ground. Switch on the sprayer and listen to check that the atomiser disc starts spinning; then open the flow valve. There may be a slight delay before spray is emitted while liquid flows down the tube to the feed nozzle.

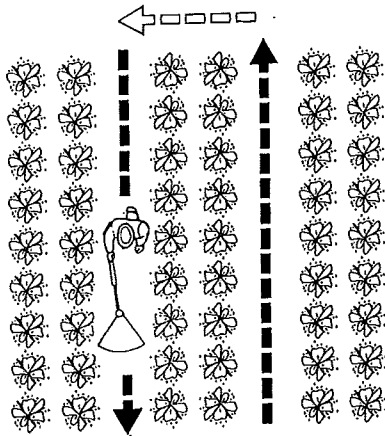

Start walking immediately the spray liquid is emitted. N.B. the machine will not spray if the spray head is above the level of liquid in the container. It is best to hold the HERBI-FLEX-4 slightly to one side so as to avoid walking over the treated area. **Always** keep the spray head away from the body to avoid direct contamination by the spray.

TO STOP SPRAYING

Close the flow valve and wait for a few moments until the spray liquid in the bottom of the atomiser cone is sprayed out and then switch off the sprayer. When the atomiser disc has stopped spinning lift the spray head so that it is above the level of liquid in the tank and the sprayer is at an angle of 45° and then open the flow control valve to drain any remaining liquid in the feed tube back into the tank. **Do not** raise the spray head until the atomiser disc has stopped spinning. Then close the flow valve. This isolates the liquid in the backpack and means it can be disconnected from the sprayer.

AFTER SPRAYING

1. Dispose of any surplus spray mix according to the product approval. Store products safely, locked up and out of the reach of children.



2. It is **essential** to clean the sprayer and bottle or backpack thoroughly using water and detergent after use. **Never** immerse the spray head in water or under a tap, since this will destroy the electric motor.

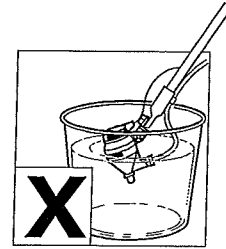

A water and detergent mix should be put in the bottle, swilled around, and then sprayed out onto the treated area or an area of waste ground. The sprayer and bottle should be wiped down externally using a cloth.

3. Periodically remove the atomiser cone housing and remove and clean the atomiser disc.

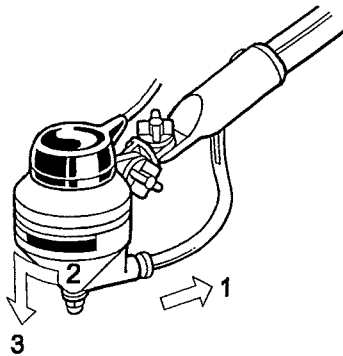

To do this first remove the feed nozzle by pulling it out of the bottom of the atomiser cone housing (1). Then remove the atomiser cone housing by rotating it an eighth of a turn clockwise (as viewed from above) to unlock the bayonet keyhole fitting (2) and pull it away from the bottom of the motor housing (3).

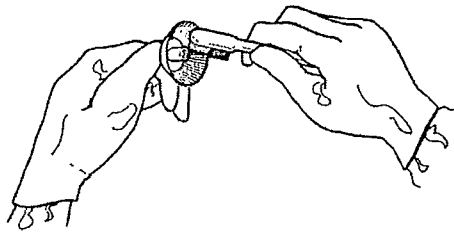

The atomiser disc can be removed from the atomiser cone housing and cleaned in soapy water using a soft brush.

TO REFIT THE ATOMISER DISC

When refitting the atomiser disc it is important to ensure that it is correctly located in the atomiser cone housing and motor housing to avoid damage.

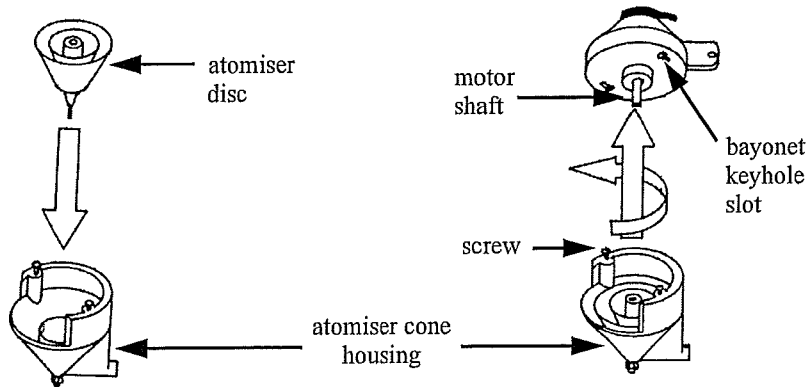

First, lower the atomiser disc into the atomiser cone housing ensuring that the disc shaft seats on the ball in the bottom of the atomiser cone assembly.

Then fit the motor housing, taking care to ensure that the motor drive shaft is correctly inserted into the slot on the top of the atomiser disc. Push the screws into the bayonet keyhole slots in the motor housing and twist to lock the assembly together.

Check that the atomiser disc is correctly fitted by shaking the spray head. If the disc can be heard rattling this means that it is fitted correctly and will spin freely.

Refit the feed nozzle, ensuring that the sealing o-ring is in place and in good condition.

4. After working with agrochemicals, or handling spraying equipment, **always** thoroughly wash hands and exposed skin. All protective clothing should be washed separately from other clothing and stored. Contaminated gloves should be washed inside and out.

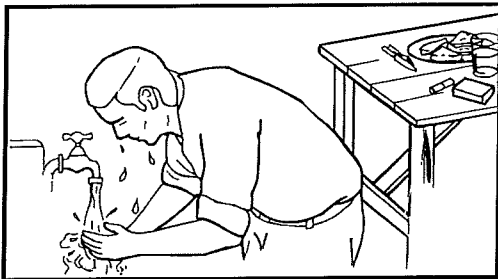

STORAGE

Before storing the HERBIFLEX-4 for long periods disassemble the sprayer by removing the four screws in the battery case and clean all electrical contacts with a wire brush or similar. Reassemble and with the sprayer in the collapsed position i.e. batteries removed, store in a dry place away from direct sunlight. Batteries should be stored in a dry place away from direct sunlight.

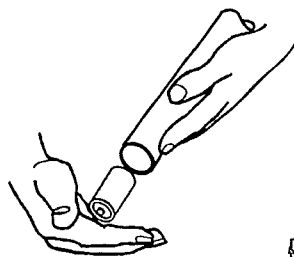

remove batteries

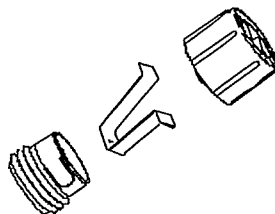

clean switch contacts

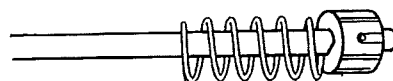

check spring

OPTIONAL EXTRAS

Spray shield

In some instances where it is essential to minimise any spray drift a spray shield can be used. This should only be used with the standard atomiser cone housing A90.

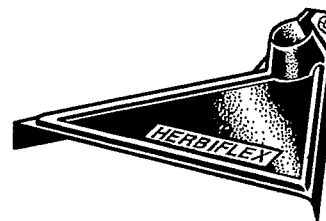

To fit the spray shield, remove the head adjustment wingnut and screw. Slip the shield over the spray head so that it sits around the top of the motor housing. Fit the screw, washers and wingnut provided with the spray shield to secure it and set the angle of the spray head.

Atomiser cone B120 (for wider swaths)

If wider swaths (up to 75 cm) are needed an atomiser cone housing with a wider opening (B120) should be used. This is supplied with a set of feed nozzles (yellow, orange and red) which give the higher flow rates needed for treating using wider swaths. (see 'MIXING, FILLING AND CALIBRATION').

This should be fitted as described in 'AFTER SPRAYING - TO REFIT THE ATOMISER DISC.'

TROUBLESHOOTING

A) Atomiser disc spins but does not spray or sprays irregularly. Check:

- the feed nozzle. If the feed nozzle is blocked remove and soak in soapy water.
Never blow through the nozzle with your mouth.
- that the feed nozzle gives a flow rate within the operating range
- the atomiser disc is clean and undamaged. Clean or replace.
- the flow valve for blockage. Clean if necessary.

B) Atomiser disc fails to spin or spins unevenly. Check:

- that the batteries are fitted correctly.
- the condition of the batteries. Replace if necessary.
- that electrical terminals and contact points are clean and that electrical wires are not broken or corroded.
- the motor for corrosion or obvious signs of wear. Replace if necessary.
- the atomiser disc and atomiser cone housing are fitted correctly (see 'AFTER SPRAYING - TO REFIT THE ATOMISER DISC').

N.B. Battery condition can be checked with a torch (or a torch light bulb and electrical wire).

C) Spray liquid spills from the atomiser cone during spraying:

- angle of the spray head to the ground is too great - reduce the angle.
- flow rate too high - fit feed nozzle with lower flow rate and reduce walking speed accordingly.

HERBIFLEX-4 EXTRA

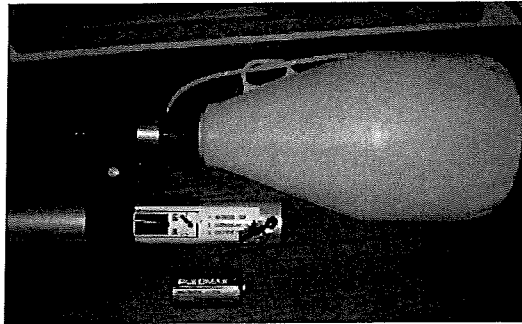

To fit the bottle to the Handle/Valve, fill the bottle to the required level and place it on a level surface. Fit the Handle/Valve into the bottle ensuring that the bottle handle is in line with the flow control valve. Tighten the bottle securing cap and pass the air bleed tube through the bottle handle. This is important to ensure that the air bleed system functions correctly.

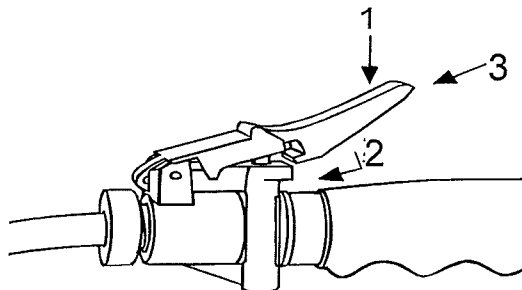

Press lever down (1) for treating small areas. Press down and forward (2) for continuous spraying. To stop flow, pull back lever and release. N.B. for safety, valve can be locked in off position by pushing lever forward (3)

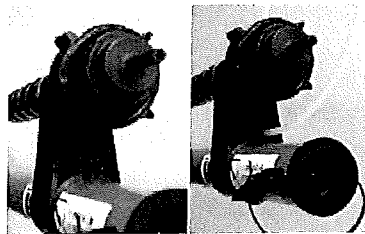

When using the backpack connector the airbled tube must be fitted to the bracket as shown

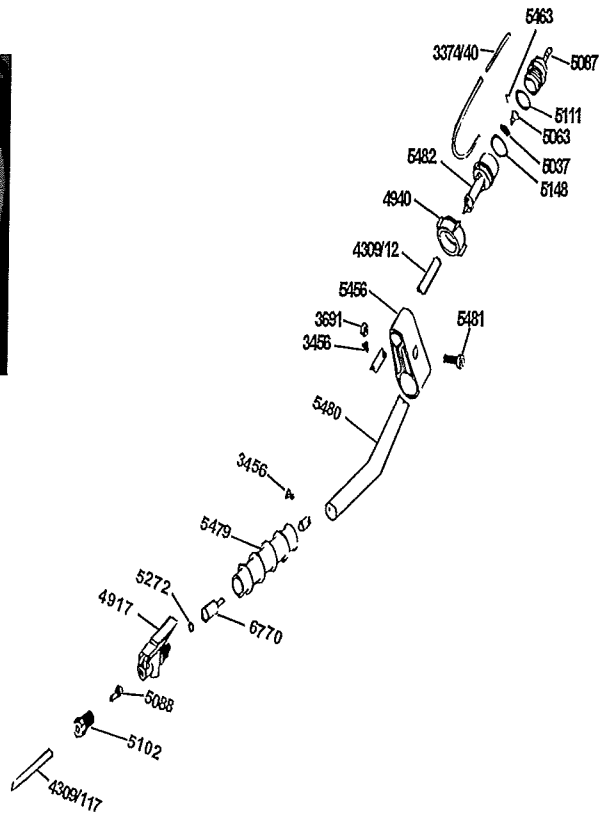

PART NO.	DESCRIPTION
3374 /40	TUBE, (NYLON) 3/16" O.D.
3456	SCREW, NO. 6 X 1/4 " S/T (B)
3691	NUT, 6MM
4309/19	TUBE, (PVC) 3/16" I.D. - 0.19M
4309/102	TUBE, (PVC) 3/16" I.D. - 1.02M
4917	VALVE, TRIGGER
4940	BOTTLE SECURING CAP
5037	FILTER GAUZE
5063	DEFLECTOR, AIR BLEED
5087	BACKPACK CONNECTOR
5088	VALVE/HOSE CONNECTOR
5102	NUT, UNION
5111	'O' RING (BS 215) - NITRILE 70
5148	'O' RING (BS 125) - VITON
5272	'O' RING (BS 108)
5456	HANDLE BRACKET
5463	PIN, BRASS, 1MM X 10MM
5477	CABLE TIE
5479	GRIP, PVC
5481	SCREW, M6 X 25 POSI PAN
5482	BOTTLE HOLDER
5483	HANDLE, ALUMINIUM
6770	VALVE/HANDLE ADAPTOR
ACCESSORIES/OPTIONAL EXTRAS	
	BOTTLE, PET, 1 LITRE
4390	BOTTLE, 2 1/2 LITRE + CAP

HERBIFLEX-4 (BASIC) PARTS LIST

PART NO.	DESCRIPTION	QTY
4309/110	TUBE, 5MM ID X 8MM OD - 1.10M, PVC CLEAR	1
4447	SPRING HOLDING PIN	1
4629/107	WIRE, 0.5MM FLAT TWIN - 1.07M	1
4646	SCREW, NO. 6 X 3/8" S/T POZI FLANGE/HEAD AB	2
4747	CLIP, 'P'	1
4896A	ATOMISER CONE HOUSING, A90 (C/W 2 X 5027)	1
4897	MOTOR HOUSING	1
4900	MOTOR COVER	1
4901	EXTENSION TUBE PIECE, HEX.	1
4908A	FEED NOZZLE, WHITE + 'O' RING (5151)	1
4910A	ATOMISER BOTTOM CONE ASSEMBLY	1
4911	DEFLECTOR	1
4916	MOTOR TERMINAL COVER, PVC	1
4921	NUT, M5, DOME, NYLON	1
4930A	FEED NOZZLE, BLUE + 'O' RING (5151)	1
4939	SCREW, NO. 4 X 1/2" S/T, POZI, PAN/HEAD, AB, S/S	4
4943	WASHER, 5.0MM X 11 X 1, FLAT, NYLON	1
4960	WASHER, 4.BA, FLAT, BRASS	2
5049A	FEED NOZZLE, BROWN + 'O' RING (5151)	1
5075	KNUCKLE JOINT	1
5076A	ATOMISER DISC ASSEMBLY	1
5107C	SHOULDER STRAP	1
5151	'O' RING, BS 011, VITON	1
5316	'O' RING, 38 X 1.5, NITRILE 70	1
5317	'O' RING, BS 110, VITON	1
5363	SPRING, BATTERY CASE	1
5375	CENTRE CONNECTOR	1
5376	BATTERY CASE END CAP	1
5399	SCREW, NO. 6 X 3/8" S/T POZI PAN/HEAD B	7
5447	BATTERY CASE	1
5486B	MOTOR, 2,800 RPM, WITH DRIVE SHAFT	1
5487	MOTOR SPACER	1
5776A	TAP	1
5778	HOSE CONNECTOR, 6MM	1
5779	UNION NUT	1
5780	VALVE CLAMP	1
5784	EXTENSION TUBE	1
5956	SCREW, M5 X 12, POZI, PAN, PT	1
6029	CLIP, HOSE, 11.9MM, SELF TIGHTENING	1
6180	LABEL, HERBIFLEX	1
7464	PLUG, SWITCH	1
7465	SLEEVE, SWITCH	1
7495	CONNECTOR, SWITCH	1
7632	LABEL, BATTERY, NEW SCREW SWITCH	1
ACCESSORIES (not shown)		
5137A	MEASURING CUP, 50ML + CAP	1
5264	CALCULATOR, HERBAFLEX	1

PARTS DIAGRAM - HERBIFLEX-4 AND MICROPAK 5 LITRE BACK-

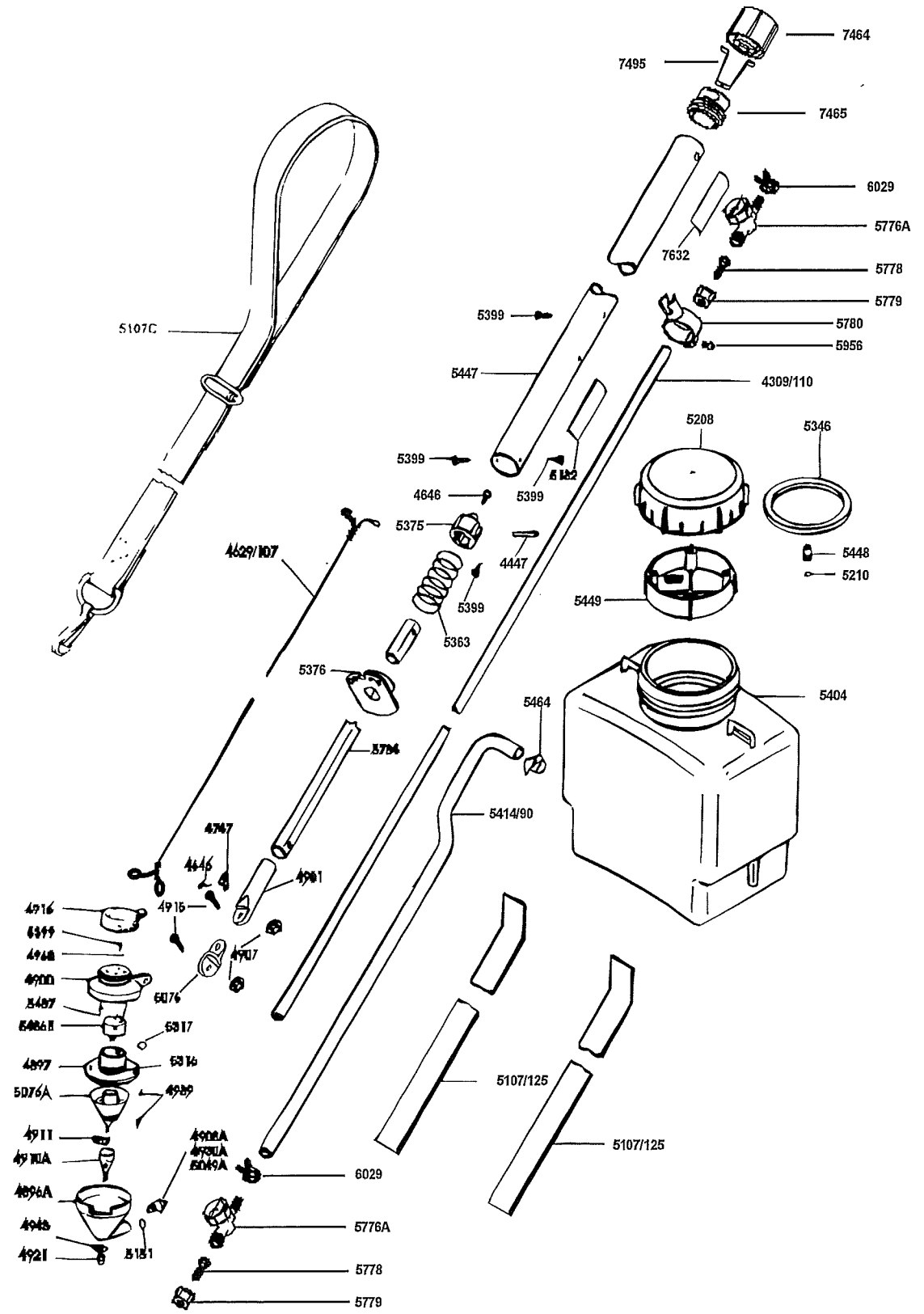

OPTIONAL EXTRAS (not shown)

PART NO.	DESCRIPTION
5074A	ATOMISER CONE HOUSING, B120 (C/W 2X 5027)
5140A	FEED NOZZLE, YELLOW + 'O'RING (5151)
5141A	FEED NOZZLE, ORANGE + 'O'RING (5151)
5142A	FEED NOZZLE, RED + 'O'RING (5151)
6495A	SPRAY SHIELD (FOR USE WITH ATOMISER CONE HOUSING A90)
5107C	SHOULDER STRAP
5404A	<i>MICROPAK</i> BACKPACK, 5 LITRE COMPLETE
5207A	<i>MICROPAK</i> BACKPACK, 10 LITRE COMPLETE
5505A	<i>MICROPAK</i> BACKPACK, 15 LITRE COMPLETE

MICROPAK 5 LITRE BACKPACK PARTS LIST

PART NO.	DESCRIPTION	QTY.
5172	TAP, IN-LINE SYPHON	1
5208A	CAP, COMPLETE	1
5208	CAP, BLACK	1
5210	BALL, 3/16" DIA, POLYPROYLENE	1
5346	SEAL, CORK	1
5404	BACKPACK, 5 LITRE	1
5107/125	STRAP, 5 LITRE BACKPACK	2
5413	CLIP, HOSE, SIZE CC, NYLON	1
5414/90	TUBE, 8MM, ID X 12MM OD - 0.9M	1
5448	AIR BLEED VALVE BODY	1
5449	FILTER BOWL	1
5464	CLIP, HOSE, NO 12, WINGSCREW	1

DECLARATION OF CONFORMITY

Name of manufacturer or supplier: Micron Sprayers Ltd.

Full postal address: Bromyard Industrial Estate,
BROMYARD, Herefordshire

Country of origin: England

Post code: HR7 4HS

Description of Product: Battery powered, hand-held
agricultural spraying
machine.

Name and model number of machine: HERBIFLEX-4

Place of Issue: Bromyard, England

Name of authorised representative: G. S. Povey

Position of authorised Representative: Joint Managing Director

DECLARATION:

I declare that as the authorised Representative, the above information in relation to the supply/manufacture of this product is in conformity with the requirements of the Machinery Directive 2006/42/EC and complies with the relevant essential health and safety requirements.

Signature of authorised Representative:

