

PROPLANT™

AUTOMATIC SEED RATE CONTROLLER



REFERENCE MANUAL



MICRO-TRAK®
SYSTEMS, INC.

PROPLANT™

AUTOMATIC SEED RATE CONTROLLER

REFERENCE MANUAL

The ProPlant is an electronic monitoring and control system that can help you achieve maximum yields and operate more cost-effectively by providing accurate control of seed rates plus the ability to vary seed rates on-the-go, via either VRA or the console keys - to match field conditions. The ProPlant has been designed for easy installation and operation. However, since each installation will vary depending on your equipment, please take time to familiarize yourself with this manual and the actual components before beginning. Following the procedures described in this manual will ensure proper performance and help avoid problems or questions once you are in the field.

This manual may be used for either English or Metric measurement. Please read the manual carefully and follow the instructions as they apply to your usage.

If you do encounter a problem that cannot be corrected by reviewing this manual, consult your dealer or distributor, or contact a Micro-Trak technician for assistance.

Toll Free in U.S. or Canada: (800) 328-9613 or (507) 257-3600

Fax: 507-257-3001

E-mail: trakmail@micro-trak.com

Web: www.micro-trak.com



MICRO-TRAK®
SYSTEMS, INC.

P.O. Box 99
111 East LeRay Avenue
Eagle Lake, MN 56024-0099

© Copyright 2007
Micro-Trak Systems, Inc.
Printed in the U.S.A.

Micro-Trak® Warranty

Micro-Trak (herein "Seller") warrants to the original purchaser (herein "Buyer") that, if any product or part of the product (herein "part") proves to be defective in material or workmanship, upon inspection and examination by Seller, within one (1) year from the original date-of-purchase, and is returned to Seller with dated proof-of-purchase, transportation prepaid, within thirty (30) days after such defect is discovered, Seller will, at their option and sole discretion, either repair or replace said part, except that the warranty for expendable parts, including but not limited to, light bulbs and batteries shall be thirty (30) days from the original date-of-purchase. Said warranty is valid only when the part has been installed, operated and maintained in strict accordance with the procedures outlined in the manual. Any damage or failure to said part resulting from abuse, misuse, neglect, accidental or improper installation or maintenance, unauthorized modification, use with other products or attributable to acts of God, as determined solely by the Seller, will invalidate the warranty. Said part will not be considered defective if it substantially fulfills the performance specification. Buyer shall be responsible for all maintenance services, if any, all in strict accordance with the procedures outlined in the manual. The warranty does not include labor, installation, replacement parts or repairs, delivery of replacement parts or repairs or time and travel. Said warranty is nontransferable.

THE FOREGOING WARRANTY IS EXCLUSIVE AND IN LIEU OF ALL OTHER WARRANTIES OF MERCHANTABILITY, FITNESS FOR PURPOSE AND OF ANY OTHER TYPE, WHETHER EXPRESS OR IMPLIED. The Seller's liability, whether in contract, in tort, under any warranty, in negligence or otherwise, shall not exceed the return of the amount of the purchase price paid by the Buyer, and under no circumstance shall the Seller be liable for special, indirect or consequential damages. Seller neither assumes nor authorizes anyone to assume for it any other obligation or liability in connection with said part. No action, regardless of form, arising out of the transactions under this agreement may be brought by the Buyer more than one (1) year after the cause of action has occurred.

Seller agrees to extend the term of the foregoing warranty period should the Buyer return completed warranty registration information, with dated proof-of-purchase, to the Seller within one (1) year from the original date-of-purchase. All conditions and limitations of said foregoing warranty, except the term of said foregoing warranty, shall apply. Said term shall be extended to a total of three (3) years from the original date-of purchase on display consoles and network communication modules, as defined by Seller, and said term shall be extended to a total of two (2) years from the original date-of-purchase on all other parts, except that the warranty for expendable parts, including but not limited to, light bulbs and batteries shall be thirty (30) days from the original date-of-purchase, and except that the warranty for parts manufactured by someone other than the Seller, including but not limited to, shut-off and control valves, DGPS receivers, memory cards and drives, mapping software, flowmeters and pressure sensors shall be one (1) year from the original date-of-purchase.

Buyer accepts these terms and warranty limitations unless the product is returned to Seller, via proper distribution channels and approved return authorization, with dated proof-of-purchase, transportation prepaid, within fifteen (15) days from the date-of-purchase for refund of the purchase price.

Units under warranty should be sent prepaid, with dated proof-of-purchase, within 30 days of discovering defect, to the address below:

MAIL AND UPS:

**Micro-Trak Systems, Inc.
Attn: Service Department
P.O. Box 99
111 East LeRay Avenue
Eagle Lake, MN 56024-0099**

Extended Warranty Option

It's simple! Just complete the enclosed registration card(s) for this product and mail it in and we'll extend your warranty for up to three years*, at no additional charge.

MAIL IN YOUR REGISTRATION CARD(S) TODAY!

Registration Card information is for internal use only.

* Some limitations apply. See warranty statement for details.

At Micro-Trak Systems, we believe a product that delivers quality and performance at a low cost is what is needed to help today's operator and the operator of the future compete in the world market.

It is our goal to provide operators with a line of electronic equipment that will help build and maintain an efficient and profitable operation that can be passed on to future generations.

We thank you for your purchase and hope that we can be of service to you in the future.

Micro-Trak Systems, Inc.

Table of Contents

Table of Contents	4
Component Parts and Assembly Hardware (single and multiple drive).....	5-6
Component Parts - Hydraulic Planter Drive Kit.....	7
ProPlant Single Drive Mounted System Layout.....	8
ProPlant Single Drive Mounted Wiring Diagram.....	9
ProPlant Single Drive Drawn System Layout.....	10
ProPlant Single Drive Drawn Wiring Diagram.....	11
ProPlant Multi Drive Mounted System Layout.....	12
ProPlant Multi Drive Mounted Wiring Diagram.....	14
ProPlant Multi Drive Drawn System Layout	14
ProPlant Multi Drive Drawn Wiring Diagram	15
Installation	16-27
Required Tools.....	16
Mounting the Display Console.....	16
Electrical Installation	16
Magnetic Speed Sensor Installation.....	17
Magnet Installation.....	17
Connecting the Speed Sensor Cable	18
Speed Sensor Options	18
Standard Remote Run/Hold Sensor and Connection	19
Care and Maintenance of your ProPlant.....	19
Calculating Ratio.....	20
Calculating your Flow Cal.....	20
Installing Planter Drive	21-22
Calculating your Hydraulic Oil Needs	22
Connecting Planter Drive Assembly.....	22
Single Drive Closed Center Configuration.....	23
Single Drive Open Center Configuration.....	24
Dual Drive Closed Center Configuration	25
Dual Drive Open Center Configuration.....	26
Multi Drive Closed Center Configuration.....	27
Multi Drive Open Center Configuration.....	28
Console Functions	29
Calibration	30-32
English/Metric Selection	30
Entering Calibration Values	30-32
Radar or GPS Speed Sensor Calibration.....	31
Exiting Calibration.....	32
Factory-loaded Calibration Values.....	32
“Special” Calibration.....	33
Operation	34-36
Manual Operation	34
Automatic Operation	35
Data Displayed in Rotary Switch Positions	35
Resetting System Counters.....	36
Clearing Counters.....	36
Troubleshooting.....	37-40
Messages/Warnings.....	37
General	38
Checking Individual Components.....	39-40
Troubleshooting Console Inputs and Outputs	40
Appendices	41-46
Appendix A: Fine Tuning Speed/Distance Calibration Value	42
Appendix B: Radar Adapter Cables.....	43
Appendix C: Conversion Chart	44
Appendix D: Replacement Parts List.....	45
Appendix E: Variable Rate Application (VRA)	46

Component Parts and Assembly Hardware - For a drawn single drive kit

If you received a mounted kit, the extension cables are included.

Before beginning installation, check the carton contents for the following items:

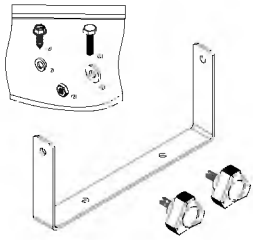

Console Mount Kit
P/N 13774



ProPlant Console
P/N 17289



Reference Manual
P/N 17329

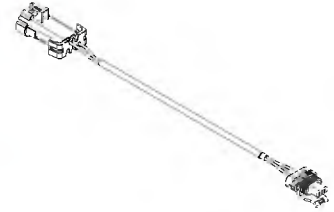

20' Section Harness (one section)
P/N 17358

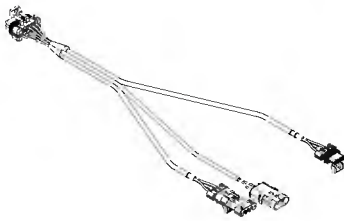

20' Flow, Servo, Run/Hold,
Branch Harness (one section)
P/N 17359

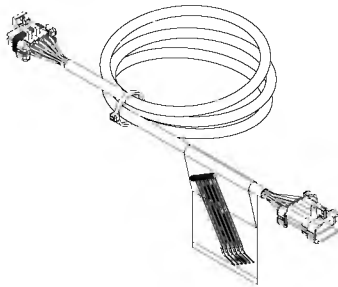

25' 10-Pin M/P Extension Cable
(1) P/N 13224

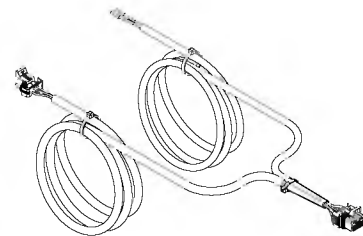

15' Power/Section Console
Harness P/N 17339

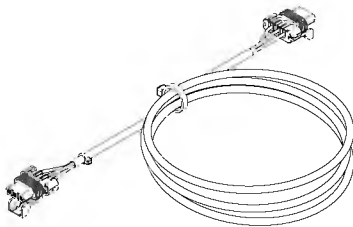

3' 3-pin M/P Speed
Adapter Cable
P/N 14324

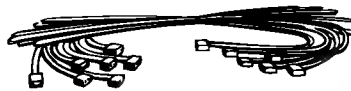

14" Nylon Cable Ties
P/N 12910

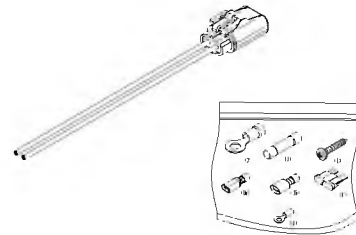

Terminal Kit w/ Fuse Holder
P/N 13270

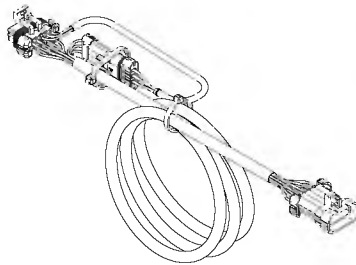

15' Flow, Servo
Run/Hold Console Harness
P/N 17360

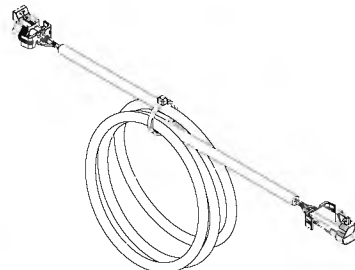

25' 5-pin M/P Extension Cable
P/N 14486

Component Parts and Assembly Hardware - For a drawn MULTIPLE drive kit

If you received a mounted kit, the extension cables are included.

Before beginning installation, check the carton contents for the following items:

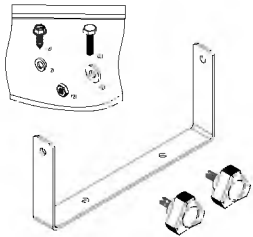

Console Mount Kit
P/N 13774



ProPlant Console
P/N 17289

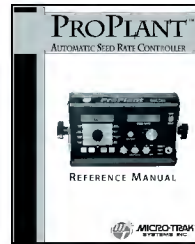

Reference Manual
P/N 17329

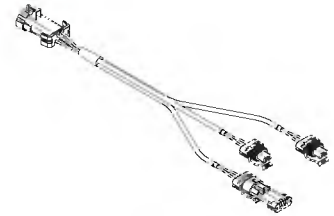

Section Branch Harness
(Sections 1-3)
P/N 17307

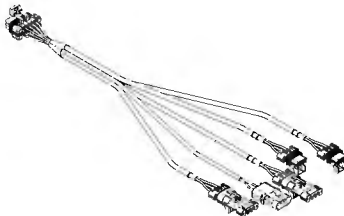

20' Flow, Servo, Run/Hold
Branch Harness (Sections 1-3)
P/N 17308

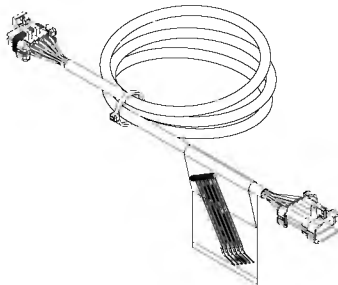

25' 10-Pin M/P Extension Cable
(1) P/N 13224

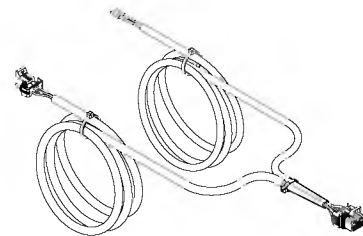

15' Power/Section Console
Harness P/N 17339

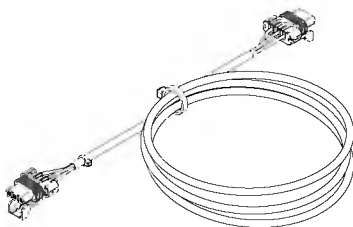

3' 3-pin M/P Speed
Adapter Cable
P/N 14324

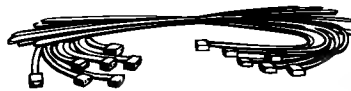

14' Nylon Cable Ties
P/N 12910

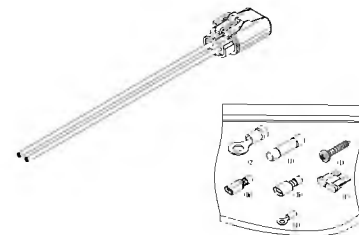

Terminal Kit w/ Fuse Holder
P/N 13270

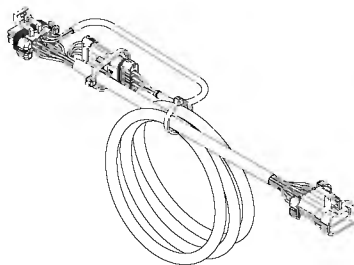

15' Flow, Servo
Run/Hold Console Harness
P/N 17360

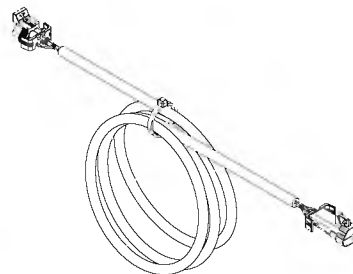

25' 5-pin M/P Extension Cable
P/N 14486

Component Parts - Hydraulic Planter Drive Kit

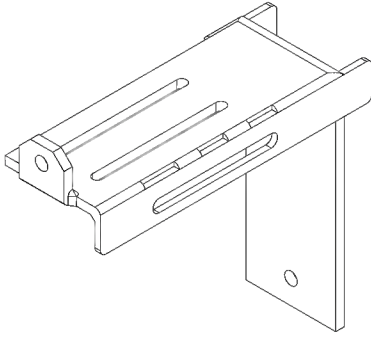

Tool Bar Bracket
P/N 17320

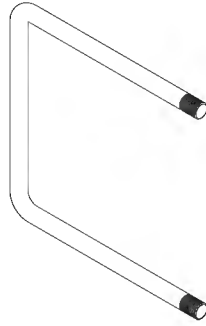

U-Bolt
P/N 17351

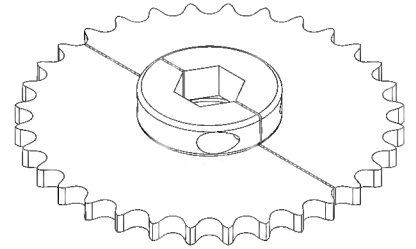

Sprocket 32 Tooth Split
P/N 17388

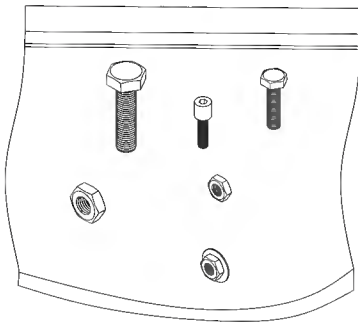

Bolt Fastener Kit
P/N 17395

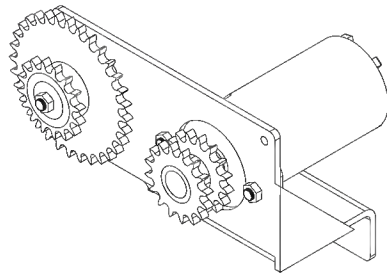

4.9 CID Motor with Motor
Bracket and Sprockets
P/N 21497

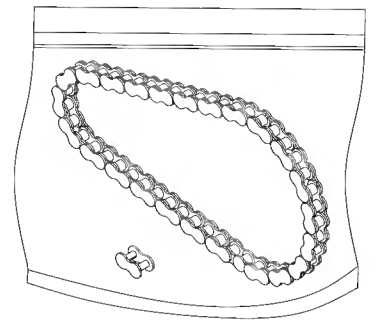

#40 Chain Kit
P/N 17396

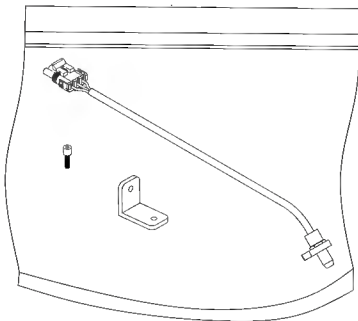

Gear Tooth Sensor Kit
P/N 17397

old style w/ plastic sensor

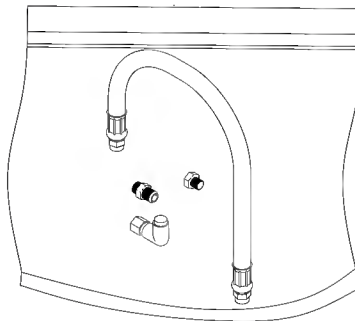

Primary Drive Fitting Kit
P/N 17399

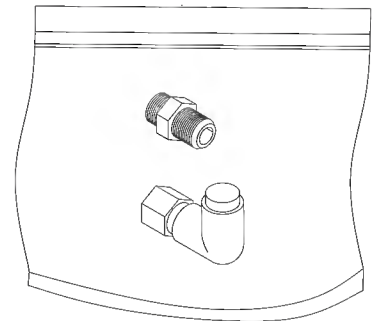

Secondary Drive Fitting Kit
P/N 17398

part # 17922
gear tooth sensor kit w/ metal sensor

part # 17917
lead only w/ metal sensor

ProPlant Single-Drive Mounted System Layout

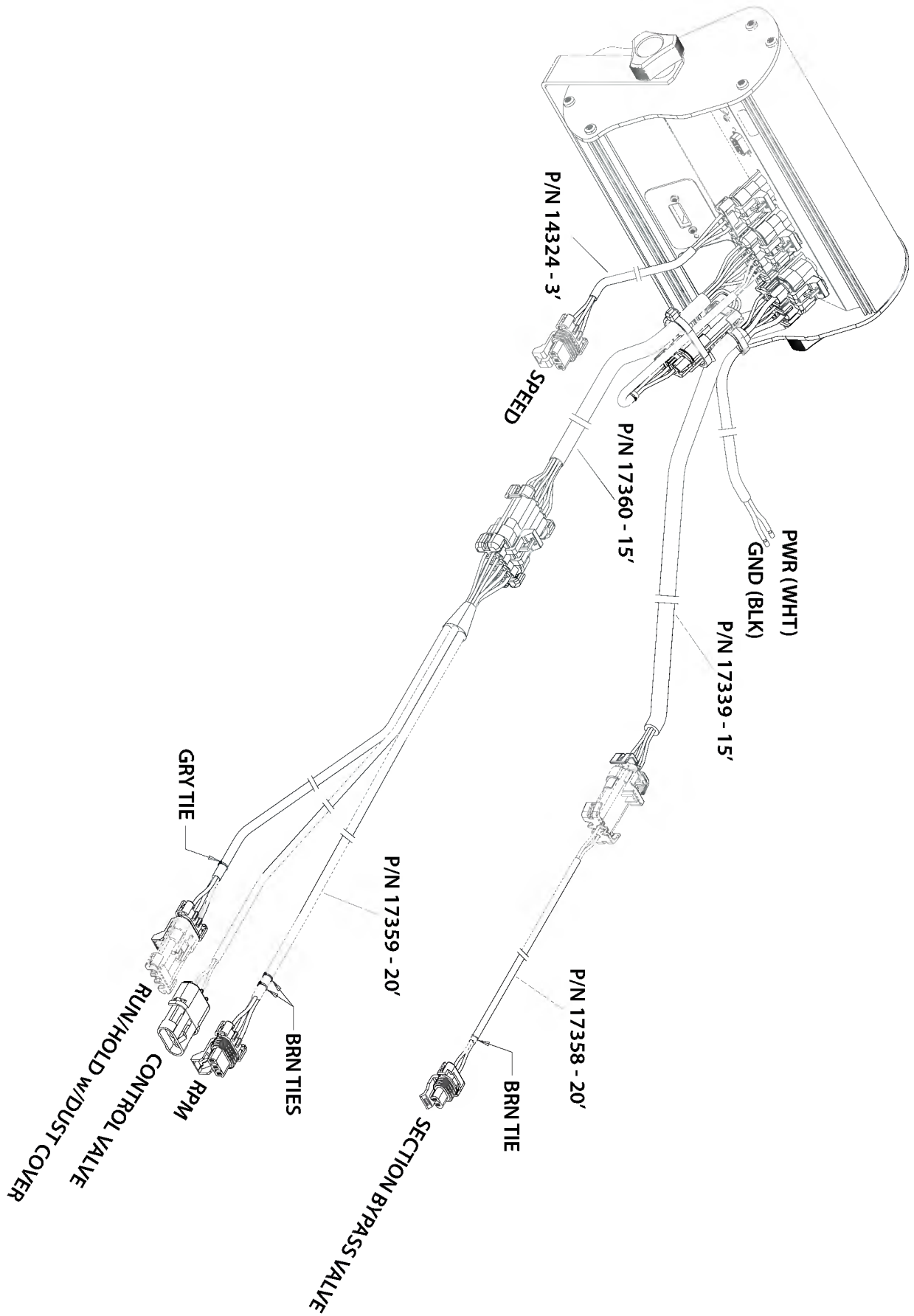

ProPlant Single-Drive Drawn System Layout

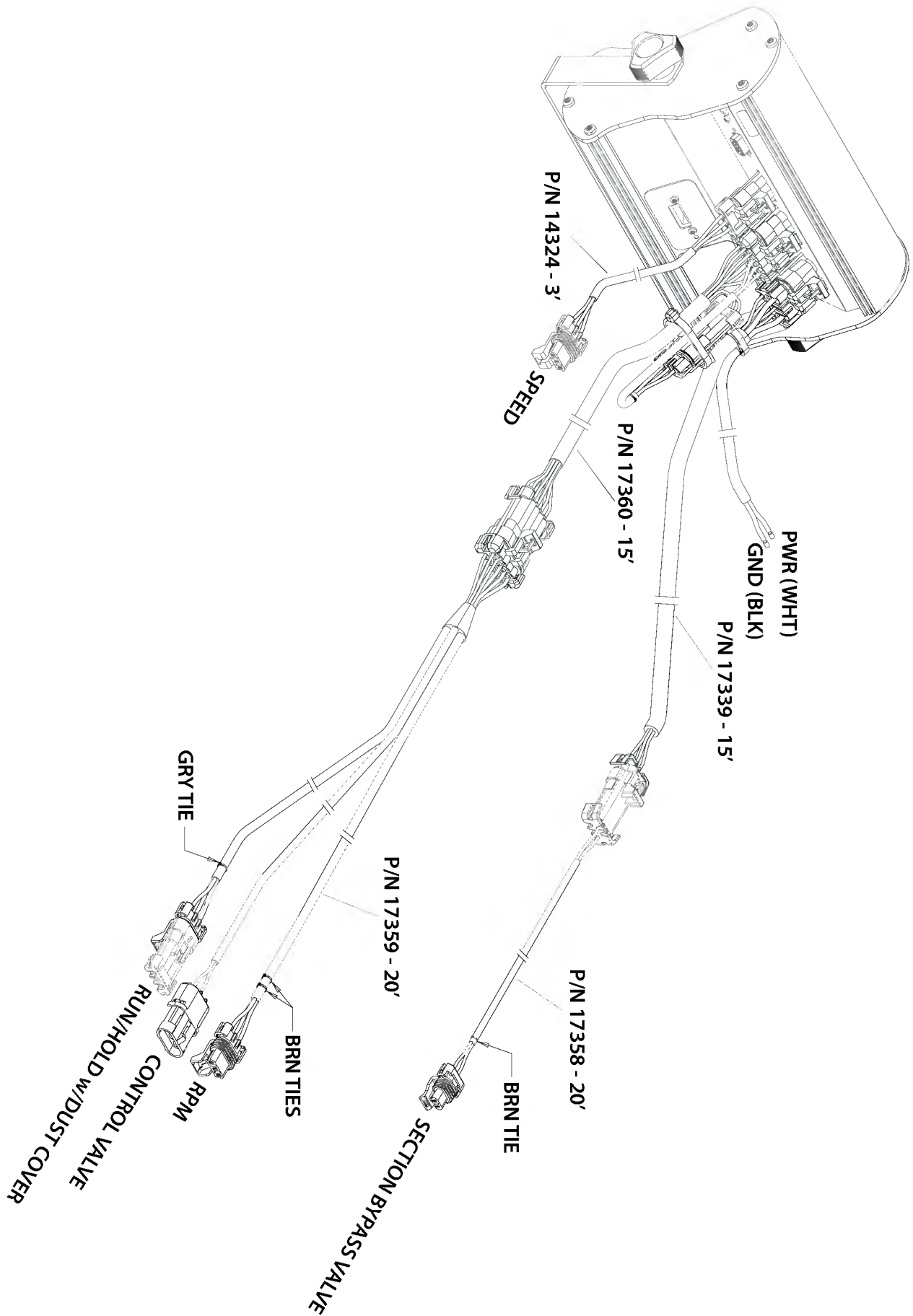

ProPlant Multi-Drive Mounted System Layout

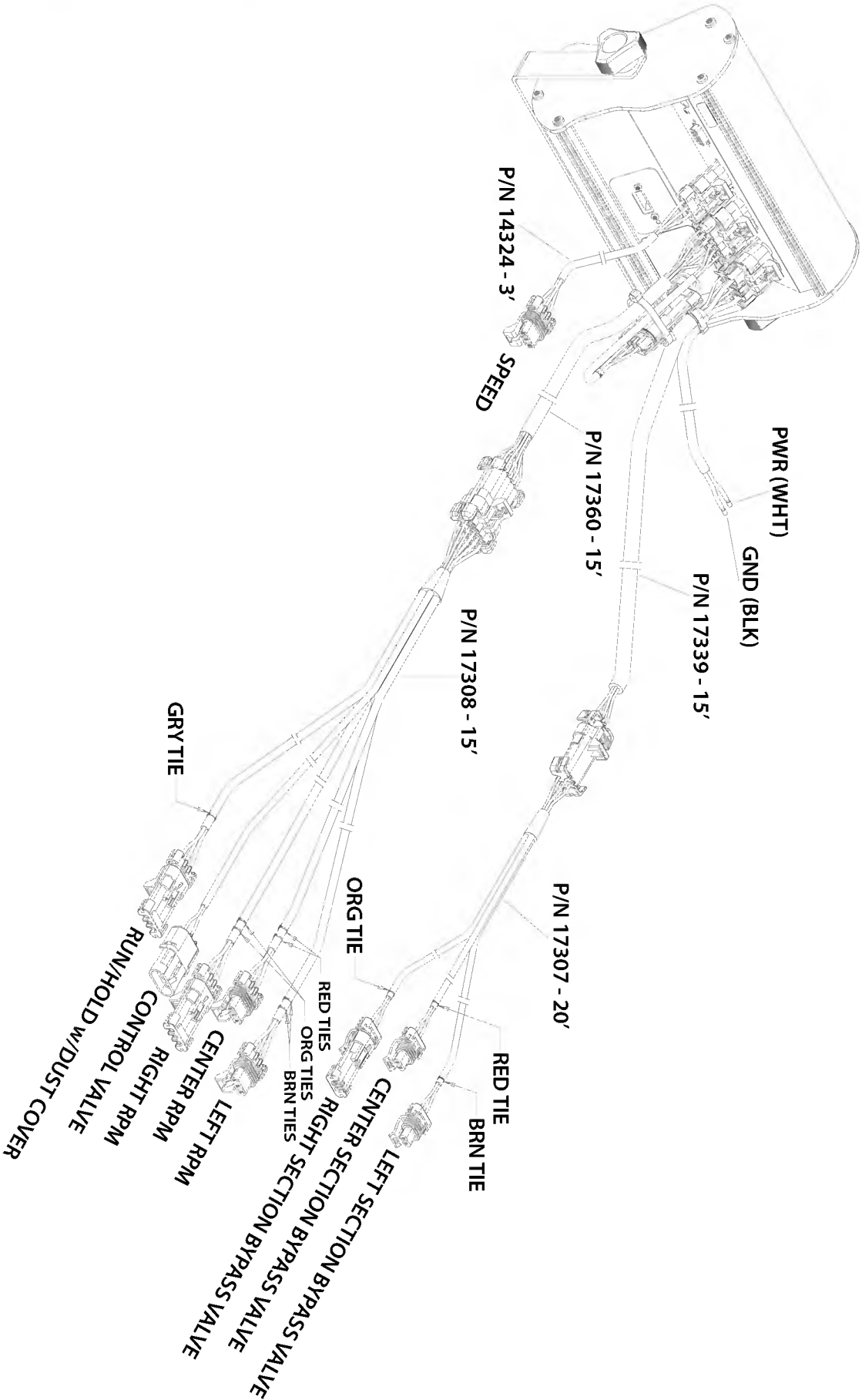

ProPlant Multiple-Drive Drawn System Diagram

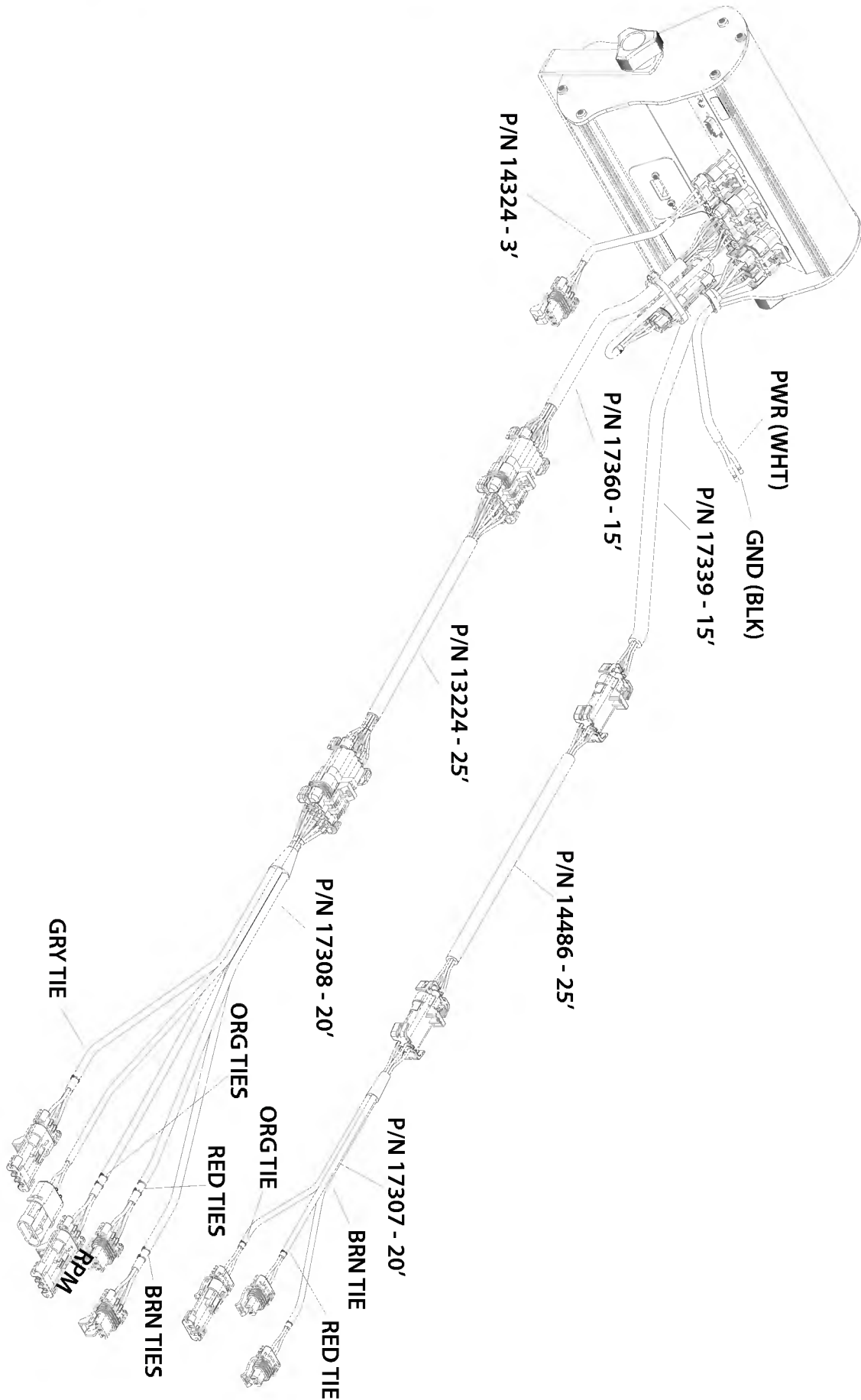

Installation

Mounting the Display Console

Select a mounting location which seems most workable, and that best fits your needs. It should be convenient to reach and highly visible to the operator. **DO NOT INSTALL IN A POSITION THAT OBSTRUCTS THE VIEW OF THE ROAD OR WORK AREA.** Whenever possible, avoid locations that expose the console to direct sunlight, high temperature, strong chemicals or rain.

Place the mounting bracket in the selected location, mark holes, drill 1/4" (7mm) holes and mount bracket with bolts, lockwashers and nuts provided. (If bolts are not practical, use self-tapping screws.) *See Illustration 1.*

Insert the console in the "U" bracket and install the console knobs through the bracket, placing a rubber washer over the threaded stud. Position console to proper viewing angle and tighten the knobs securely.

Tools Needed to Install ProPlant

- Screwdrivers
- Set of Wrenches
- Electric Drill and Bits
- Center Punch
- Pliers
- Wire Cutter
- Hammer
- 12-Volt Test Light

Illustration 1

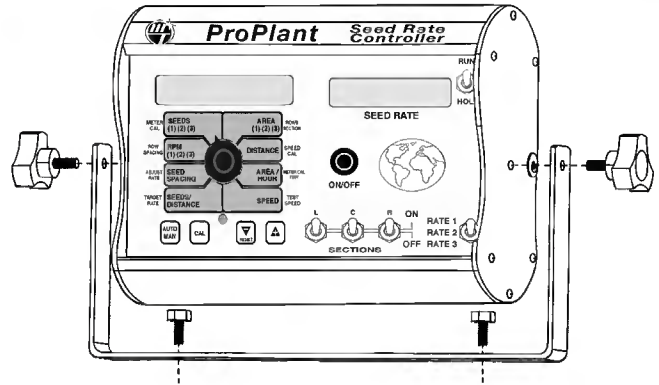

Electrical Installation

The ProPlant must be connected to a 12-volt DC electrical system. Power is connected directly to the battery. The ProPlant has an ON/OFF switch on the console to turn the power off when the system is not being used.

Locate the power cable harness and connect to the mating connector on the console. Connect the blue chassis ground wire to a good frame ground. *See Illustration 2.* Make sure there is good metal-to-metal contact. Route the power cable from the console to the battery. Cut off excess length. In routing cable to battery, avoid areas where the cable may be subjected to abrasion or excessive heat. Install the in-line fuse provided with the kit on the white wire, as illustrated, to protect the circuit. Connect the ORANGE wire (hot) from the fuse holder to the positive battery terminal. Attach the BLACK wire (ground) to a screw or bolt on the equipment frame. *See Illustration 2.* Be sure there is good metal-to-metal contact.

Your ProPlant is equipped with a non-volatile electronic memory which does not require a constant supply of power to retain daily totals or calibration values. The advantage with this type of memory is that it conserves battery power and will not discharge the vehicle's battery when equipment is not in use.

Illustration 2

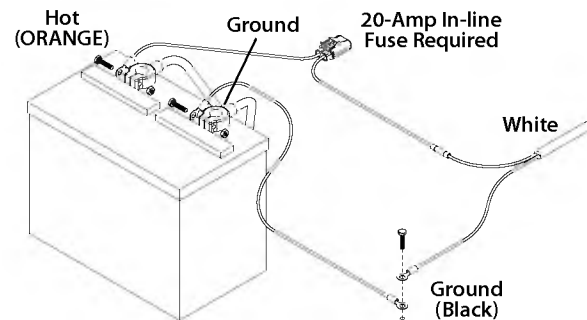

NOTE: For negative ground systems only.

Installation (cont)

Magnetic Speed Sensor Installation

Please Note: If you have purchased an Astro 5 GPS Speed Sensor or a Vansco radar speed sensor, disregard the following section on magnetic speed sensors and install the speed sensor as described in the instructions included with the unit.

Locations where the sensor may be installed:

1. Non-driven wheel on vehicle. This is less susceptible to errors resulting from wheel slip.
2. Vehicle drive shaft. This type of mounting is recommended for trucks, four-wheel drive tractors or other equipment that has poor or no access to a non-driven wheel.

Locate the following parts:

- Speed sensor cable (Green body)
- Mounting "L" bracket
- Magnets
- Cable ties

The magnets are attached to a wheel hub or drive shaft and the speed sensor is mounted directly over the magnet. When the wheel or drive shaft begins turning, a speed impulse is sent to the ProPlant console every time a magnet passes by the tip of the speed sensor. For the speed sensor to operate properly, the spacing between the magnets and the tip of the sensor must always remain constant. Before permanently mounting any parts, be sure that the location you have selected will meet the requirements shown in *Illustration 3*.

NOTE: Observe magnet polarities (See Magnet Installation Section).

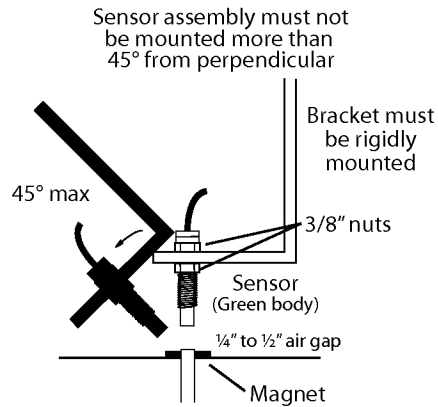

Illustration 3

Magnet Installation

Please read the following information about magnet spacing and polarity.

The number of magnets that must be used depends on the size of your tire and where you mount the sensor. On ATV, tractor or implement wheels the general rule of thumb is one magnet for each wheel bolt (minimum of two, and always an even number). For drive shafts or small wheels, two magnets are usually adequate.

To determine the number of magnets required, measure the distance traveled of one revolution of the sensor equipped wheel in inches (centimeters).

Refer to the tables to determine the minimum number of magnets required for the measured distance.

English or Turf (inches)

Wheel Circumference	40	80	120	160	200
Number of Magnets	2	4	6	8	10

Metric (cm)

Wheel Circumference	100	200	300	400	500
Number of Magnets	2	4	6	8	10

Illustration 4C

NOTE: Magnets may be attached mechanically or adhered with epoxy or other high quality adhesive. When using adhesive, thoroughly clean the area of dirt and oil.

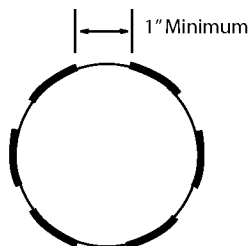

Always use an even number of magnets, and always alternate the polarities of the magnets as you go around the wheel hub or drive shaft.

The magnets provided by Micro-Trak are marked with a dashed line on the SOUTH pole side of the magnet.

See Illustration 4A.

To install, mount the first magnet with the SOUTH pole side (dashed line) facing toward the hub or shaft. Mount the second magnet with the NORTH pole side facing toward the hub or shaft. **See Illustration 4B.**

For proper operation, the magnets must be evenly spaced around the wheel or drive shaft. The magnets must be at least 1" apart. **See Illustration 4C.**

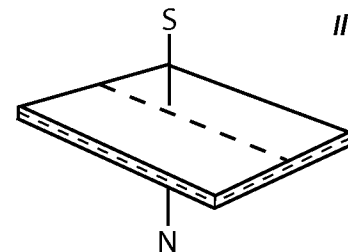
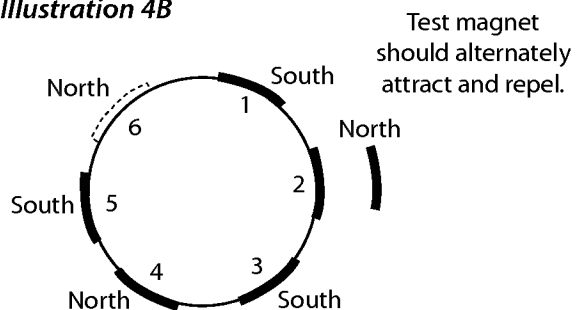

Illustration 4A

Illustration 4B



Installation (cont)

Connecting the Speed Sensor Cable

The speed sensor cable has a GREEN sensor body and mates with the 3-pin connector which is marked with a YELLOW cable tie. See *ProPlant Wiring Diagram on pages 9, 11, 13, or 15.*

The optional RPM sensor uses the same type of connector as the speed sensor. The RPM sensor body is black and connects to the main harness 3-pin connector with a red tie. See *ProPlant Wiring Diagram on pages 9, 11, 13, or 15.*

SENSOR IDENTIFICATION CHART

SENSOR	SENSOR BODY COLOR	CONNECTOR TIE COLOR
Speed	Green	Yellow
RPM	Black	Brown
Run/Hold	Black	Gray

Speed Sensor Options

The ProPlant may be interfaced with a variety of speed sensing equipment. Several options are listed below.

Astro Series or other GPS Speed Sensor Interfaces

The ProPlant may also be used with most GPS speed sensors that output a pulsed signal, such as the Micro-Trak Astro II and 5, SkyTrak or Dickey-John GPS speed sensors. An adapter cable may be required.



Astro 5 GPS Speed Sensor

Vansco™ Radar Speed Sensor

The Vansco radar speed sensor uses a microwave (radar) signal to deliver a reliable, accurate speed signal for electronic equipment. It features state-of-the-art electronic design/manufacturing, rugged housing and complete testing and certification.

Radar Interface

The ProPlant may also be interfaced with most popular radar ground speed sensors. An adapter cable is required for proper interface.

SEE APPENDIX FOR LIST OF ADAPTER CABLES FOR RADAR.



Vansco Radar Speed Sensor

Contact a Micro-Trak sales representative for details on any of these products, or call Micro-Trak Systems, Inc. at 1-800-328-9613.

Installation (cont)

Standard Run/Hold Sensor and Connection

Remote Run/Hold

The run/hold sensor cable has a BLACK body and mates with the main harness cable having a GRAY cable tie near the 3-pin M/P connector. Make certain that you install the correct sensor cable and connect it to the correct connector on the main harness.

- The basic idea is to attach a magnet to a lever or some part of the equipment that moves when the implement is raised and lowered. The Hall-effect Run/Hold sensor is sensitive only to the south pole of the magnet. Install the magnet with the dashed line facing the sensor. When the magnet is away from the sensor, the console will be in HOLD and the area and distance counting functions will be disabled. NOTE: The run/hold kit includes a 5' sensor cable and 10' extension. You may require additional extension cables which are available in 5 ft. (1.5 m), 10 ft. (3 m), 15 ft. (4.5 m), 20 ft. (6 m) and 25 ft. (7.6 m) lengths.
- You may also use a toggle or other type switch. Simply cut the black jumper wire in the dust cover and splice on an appropriate length of wire to reach your switch. Do not connect to a switch with power.

When switch is closed, console is in RUN. When the switch is open, the console is in HOLD.

Lift Wheel Mounting

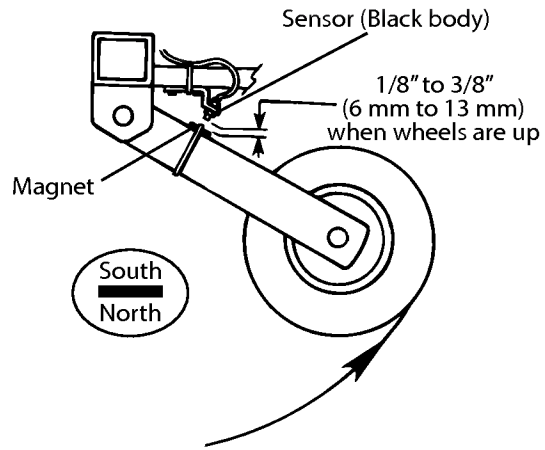

Hydraulic Cylinder Mounting

Remote Run sensor on hydraulic cylinder. Magnet and sensor are in line when equipment is lowered and operating.

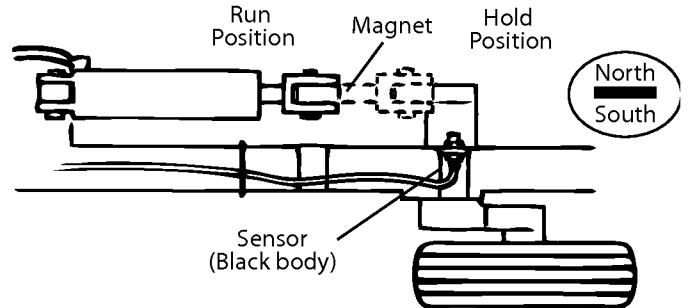

Care & Maintenance of your ProPlant™ Console

- Store the console in a cool dry location if it will not be used for an extended period of time, such as during the off-season.
- As with any electronic equipment, use care in cleaning so that water or other liquids do not enter the case.

Installation (cont)

Calculating Planter Drive Ratio

The value for Driven or Drive Sprocket refers to the number of teeth on the sprocket.

To calculate Ratio for a single stage chain drive, use the following equation:

(Driven Sprocket ÷ Drive Sprocket)

EXAMPLE: $32 \div 16 = 2.000$

This means the Drive Sprocket will need to make 2 complete revolutions in order for the Driven Sprocket to make 1 revolution.

To calculate Ratio for a two stage chain drive, use the following equation:

(First Stage Driven Sprocket ÷ First Stage Drive Sprocket) x (Second Stage Driven Sprocket ÷ Second Stage Drive Sprocket)

EXAMPLE: $(32 \div 16) \times (28 \div 16) = 3.500$

In the above example, the First Stage Drive Sprocket will need to make 3.5 complete revolutions in order for the Second Stage Driven Sprocket to make 1 revolution.

To calculate Ratio for a three stage chain drive; use the following equation:

(First Stage Driven Sprocket ÷ First Stage Drive Sprocket) x (Second Stage Driven Sprocket ÷ Second Stage Drive Sprocket) x (Third Stage Driven Sprocket ÷ Third Stage Drive Sprocket)

EXAMPLE: $(32 \div 16) \times (28 \div 16) \times (24 \div 18) = 4.666$

In the above example, the First Stage Drive Sprocket will need to make 4.666 complete revolutions in order for the Third Stage Driven Sprocket to make 1 revolution.

Enter your calculated Ratio in the Ratio setting of "Special Cal".

Calculating your Flow Cal for a Planter Drive

1. Rows equals the number of rows the drive is running.
ROWS = _____
2. How many seeds are dispensed per revolution of your Seed Meter Disc?
SMD = _____
3. What is the Ratio of hydraulic motor revolutions to seed meter revolutions?
RATIO = _____ to 1
4. How many teeth are there on your Motor Sensor Sprocket?
MSS = _____

$1000 \text{ Seeds} \div \text{ROWS} = \text{Seeds per Row}$
 $\text{Seeds per Row} \div \text{SMD} = \text{Seed Meter Revolutions}$
 $\text{Seed Meter Revolutions} \times \text{RATIO} = \text{Motor Revolution}$
 $\text{Motor Revolution} \times \text{MSS} = \text{Pulses per 1000 Seeds (Flow Cal)}$

EXAMPLE:

ROWS = 12

SMD = 30

RATIO = 4.0

MSS = 16

$1000 \text{ Seeds} \div 12 = 83.333$

$83.333 \div 30 = 2.777$

$2.777 \times \text{Ratio} = 11.111$

$11.111 \times 16 = 177.8$

177.8 = Flow Cal or Pulses per 1000 Seeds.

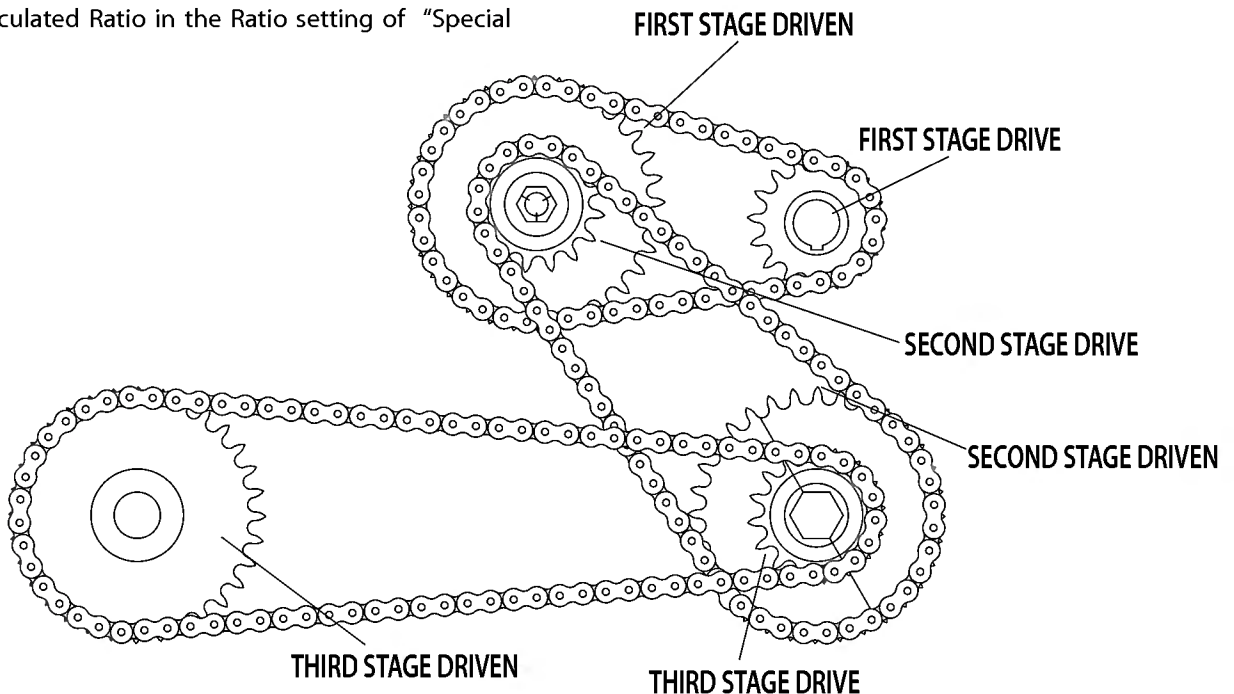

Installation (cont)

Installing the Planter Drive

1. Choose a location between row units for the tool bar mount bracket approximately five inches to the left of a hex shaft hanger bearing to the center of the tool bar mount bracket. Mount the bracket to the tool bar using the supplied 1/2" U-bolt making sure the bracket is square with the tool bar. It is important to mount the drive assembly as close as possible to a hex shaft hanger bearing.
2. Mount the motor bracket assembly to the tool bar bracket using the four 3/8" by 1 1/4" flange bolts. Slide the motor bracket towards the tool bar as far as it will go and tighten the flange bolts.
NOTE: Skip step 3 if you are installing a secondary drive assembly.
3. Mount the hydraulic flow control valve to the motor bracket using the two 5/16" by 2 3/4" bolts and 5/16" flange nuts. Be sure the output of the control valve is pointed away from the tool bar.
4. Install the split sprocket on the hex shaft. Align the hex shaft sprocket with the outside idler sprocket and tighten.
5. Cut a piece of chain to 23 1/2" and install on inside motor sprocket and idler sprocket using one of the supplied connector links. Tighten chain by loosening idler sprocket and sliding down and retighten.
6. The length of chain required between the outside idler sprocket and hex shaft sprocket varies by planter manufacturer and model, so you will need to measure to determine the length. Cut to length and install using the supplied connector link.
7. Loosen the four 3/8" flange bolts installed in step 2.
8. Locate the full threaded 1/2" by 3" bolt, 1/2" jam nut and 1/2" flat washer. Install the flat washer on the bolt and insert through the tab on the back of the tool bar bracket, thread the jam nut on and then thread bolt into the motor bracket. Use this bolt to adjust the chain between the idler and the hex shaft and tighten the four 3/8" flange bolts.
9. Locate the four SAE #8 male x JIC #8 male straight adapters and two 90 degree swivel nut elbows and install in both the "P" pressure and "T" tank ports on the valve mounted on top of the hydraulic motor. The other two adapters go in the input and output ports on the control valve. Install the elbows on the "P" port on valve and output port on control valve.
10. Locate the 1/2" hose assembly and install between the "P" port and output port.
11. Locate the SAE #8 male plug and install in the bypass port of the control valve unless the drive assembly is connected to an open center hydraulic system.
12. Install the sensor bracket to the motor bracket near the motor sprocket using one of two 1/4" by 3/4" bolts and flange nuts.13. Install gear tooth sensor to sensor bracket using the remaining 1/4" by 3/4" bolt and flange nut and adjust so that the sensor is pointed directly at the center of the motor shaft and 1/16" away from the tip of the sprocket teeth.

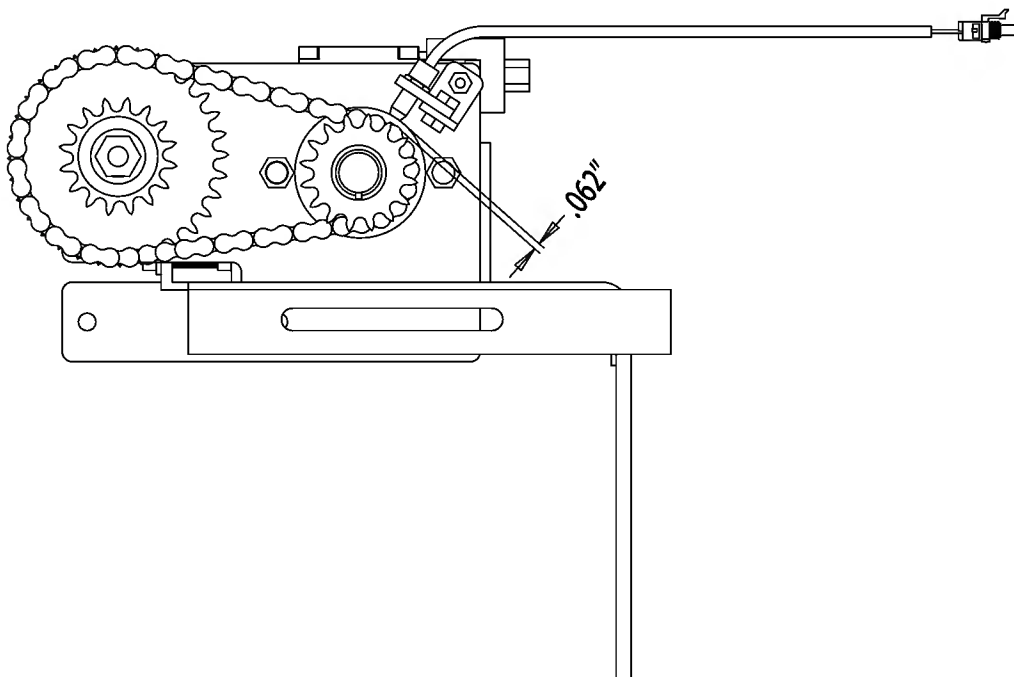

Installation (cont)

Installing the Planter Drive (cont)

Calculate your Hydraulic Oil Needs

1. What is your Maximum Planting Speed in miles per hour?

MPS = _____

2. What is the closest Desired Seed Spacing in inches?

DSS = _____

3. How many seeds are dispensed per revolution of your Seed Meter Disc?

SMD = _____

4. What is the Ratio of hydraulic motor revolutions to seed meter revolutions?

Ratio = _____ to 1

5. What is the Displacement in Cubic Inches of the hydraulic motor on your planter drive assembly?

CID = _____

EXAMPLE:

MPS = 5

DSS = 6.5

SMD = 30

Ratio = 5.333

CID = 4.9

- $(\text{MPS} \times 5280) \times 12 = \text{Inches traveled per hour}$
 $(5 \times 5280) \times 12 = 316800 \text{ inches traveled per hour}$
- $\text{Inches traveled per hour} \div \text{DSS} = \text{Seeds per hour}$
 $316800 \div 6.5 = 48738.46 \text{ seeds per hour}$
- $\text{Seeds per hour} \div \text{SMD} = \text{Seed meter revolutions per hour}$
 $48738.46 \div 30 = 1624.6 \text{ seed meter revolutions per hour}$
- $\text{Seed meter revolutions per hour} \div 60 = \text{Seed meter revolutions per minute}$
 $1624.6 \div 60 = 27 \text{ seed meter revolutions per minute}$
- $\text{Seed meter revolutions per minute} \times \text{Ratio} = \text{Hydraulic motor revolutions per minute}$
 $27 \times 5.333 = 144.4 \text{ hydraulic motor revolutions per minute}$

NOTE: the minimum recommended motor RPM is 30.

- $\text{Hydraulic motor revolutions per minute} \times \text{CID} = \text{Cubic inches of hydraulic oil per minute}$
 $144.4 \times 4.9 = 707.6 \text{ cubic inches of hydraulic oil per minute}$
- $\text{Cubic inches of hydraulic oil per minute} \div 231 = \text{Gallons of hydraulic oil per minute}$
 $707.6 \div 231 = 3 \text{ gallons of hydraulic oil per minute}$

Connecting the Planter Drive Assembly to the Hydraulic System

Determine your hydraulic system type before proceeding.

Is it an:

- Open Center System?
- Closed Center System?
- Pressure Compensating
- Closed Center Load Sensing?

From a hose connectivity standpoint, there are just **TWO VARIATIONS** in plumbing and are referred to here as either Open Center or Closed Center configurations.

NOTE: See the illustrations on the following pages for hydraulic hose plumbing detail for opened and closed center hydraulic systems as well as single, dual and multi-drive configurations.

The hose end fitting required to mate with the supplied adapters is a #8 JIC 37 degree female.

The recommended hydraulic hose size is 1/2" for both the pressure and return hoses.

Be sure to route hoses away from pinch points and leave enough excess length to accommodate folding and unfolding.

Whether you have an open or closed hydraulic system be sure to turn the oil flow down to about 20% more than calculated because the excess oil flow means excess heat.

See how to calculate your hydraulic oil needs at the top of this page.

Single Drive Closed Center Configuration

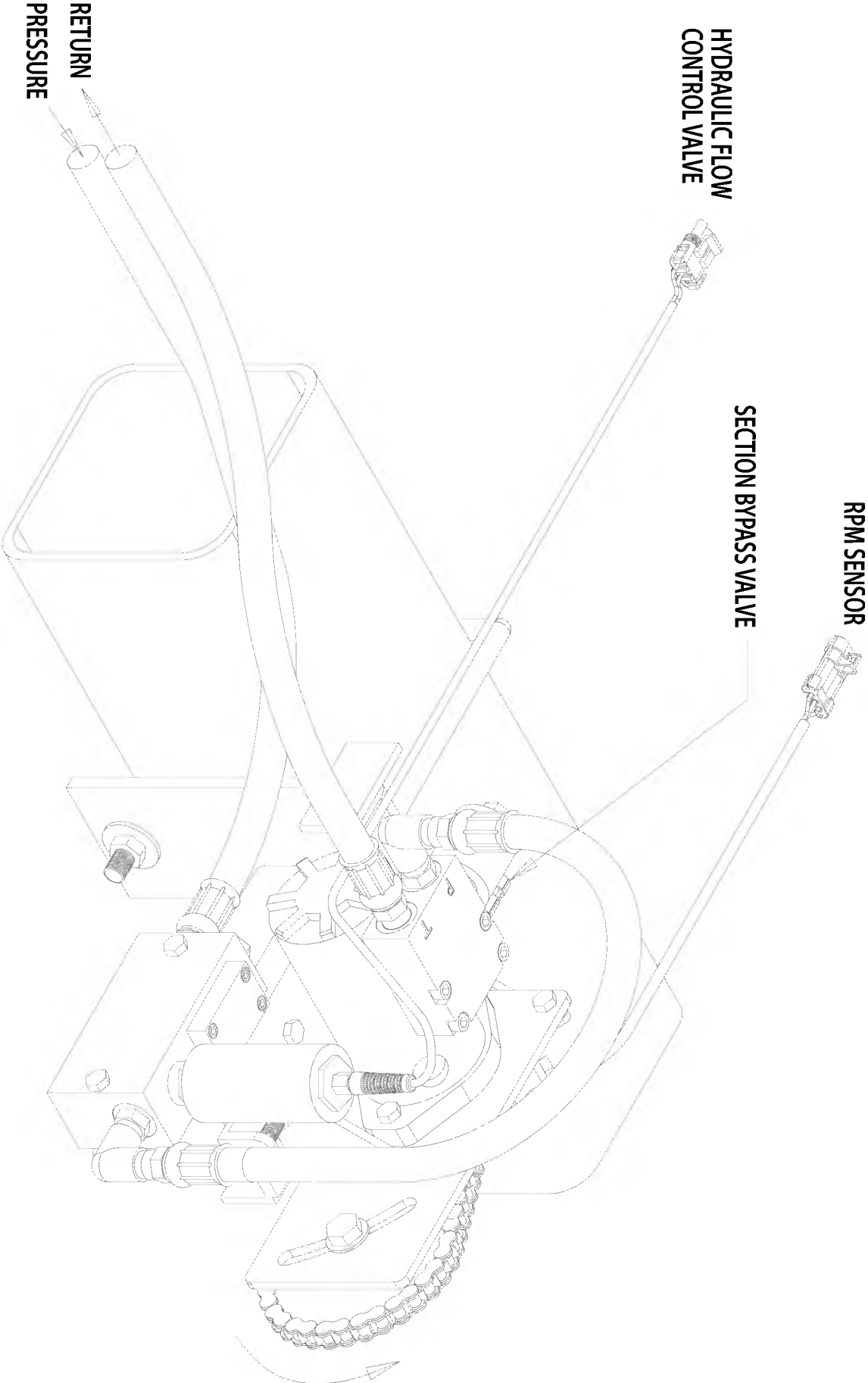

Single Drive Open Center Configuration

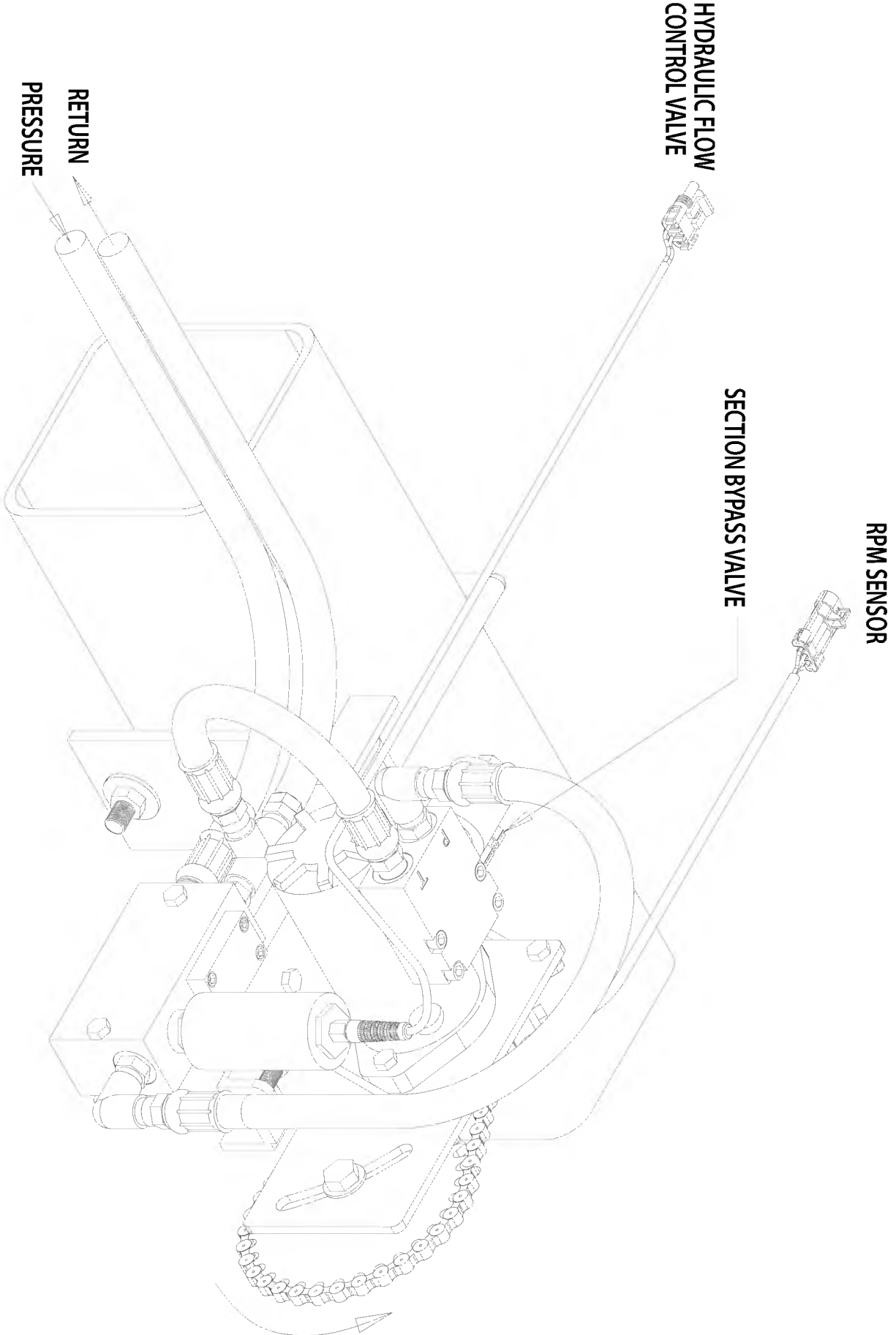

Dual Drive Closed Center Configuration

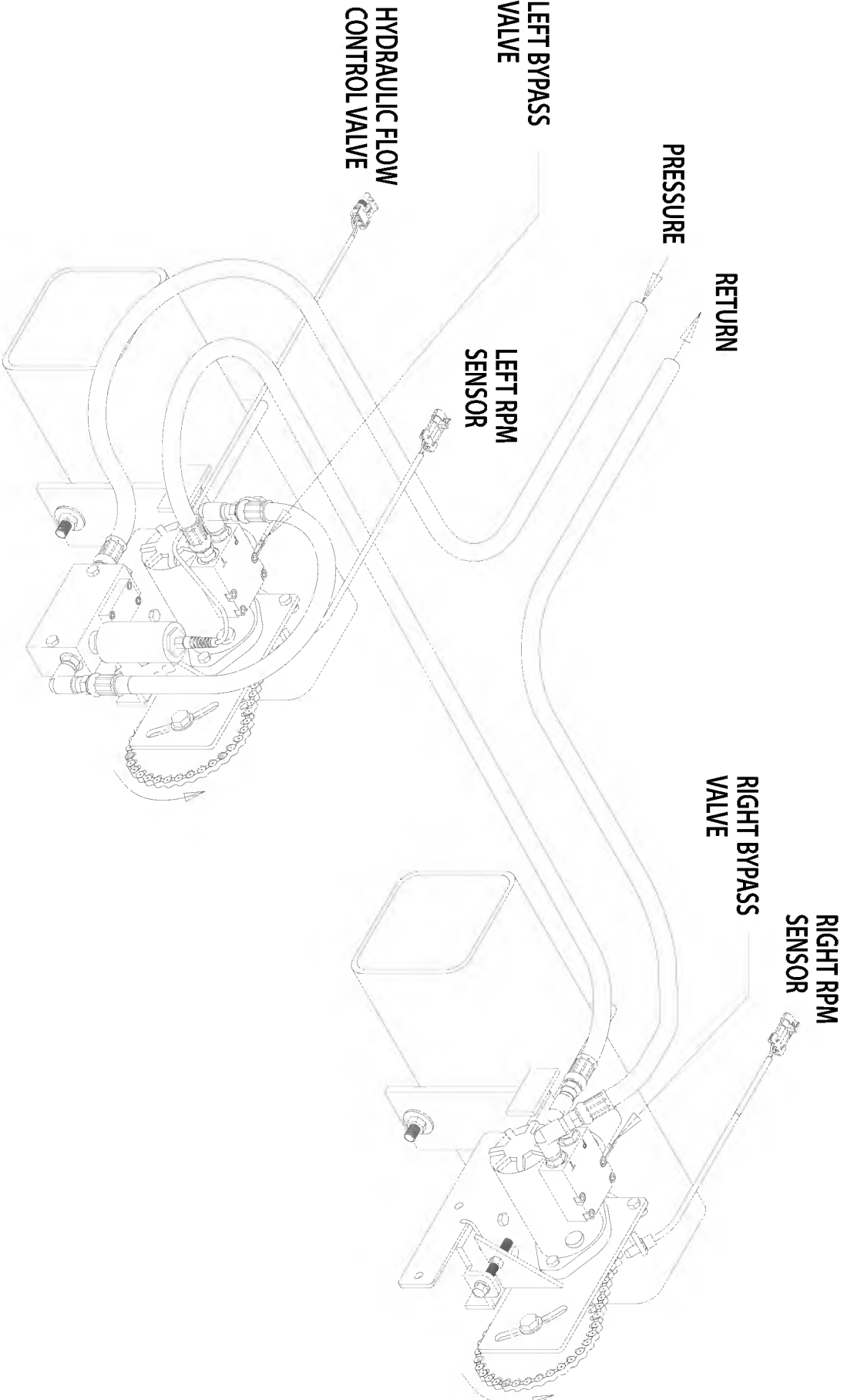

Dual Drive Open Center Configuration

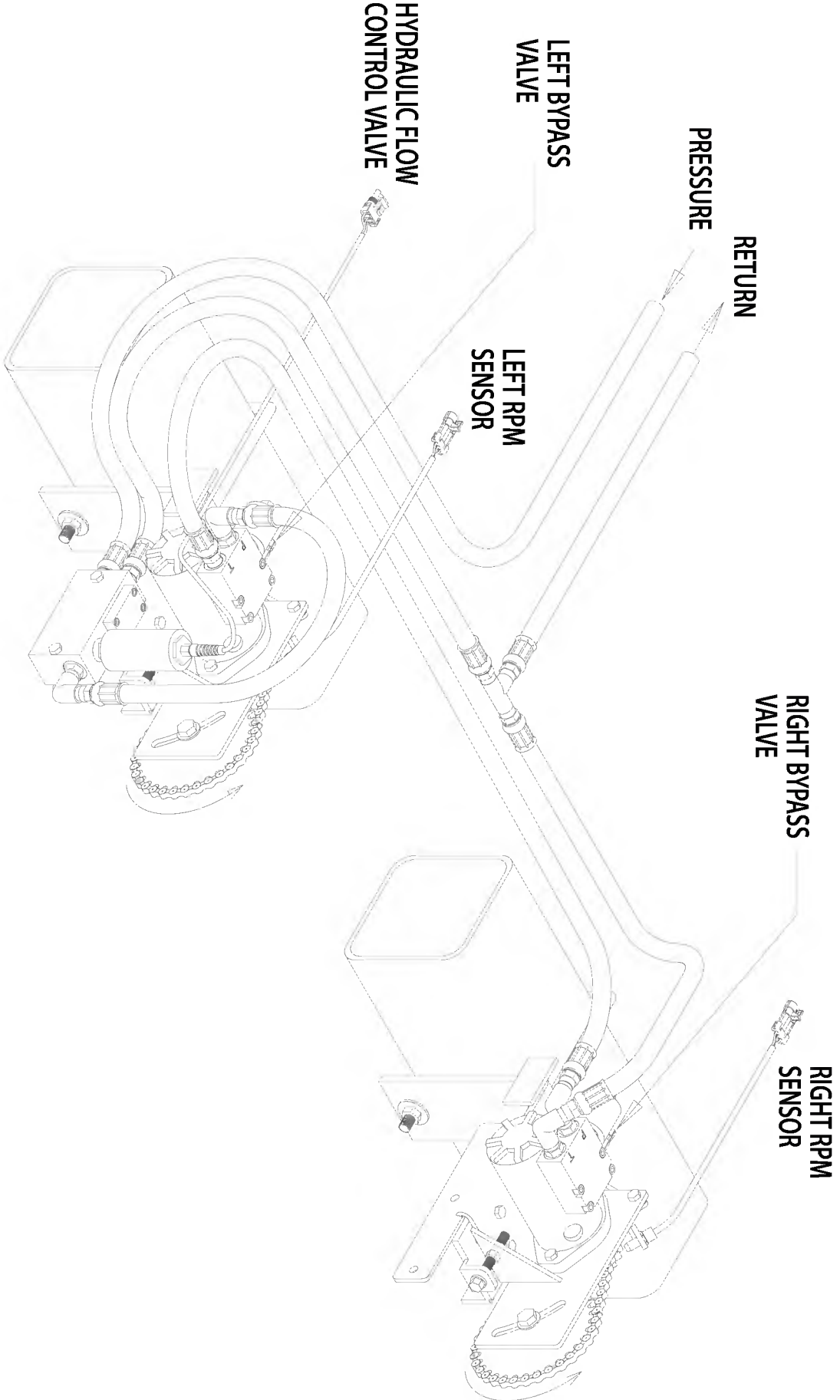

Multi- Drive Closed Center Configuration

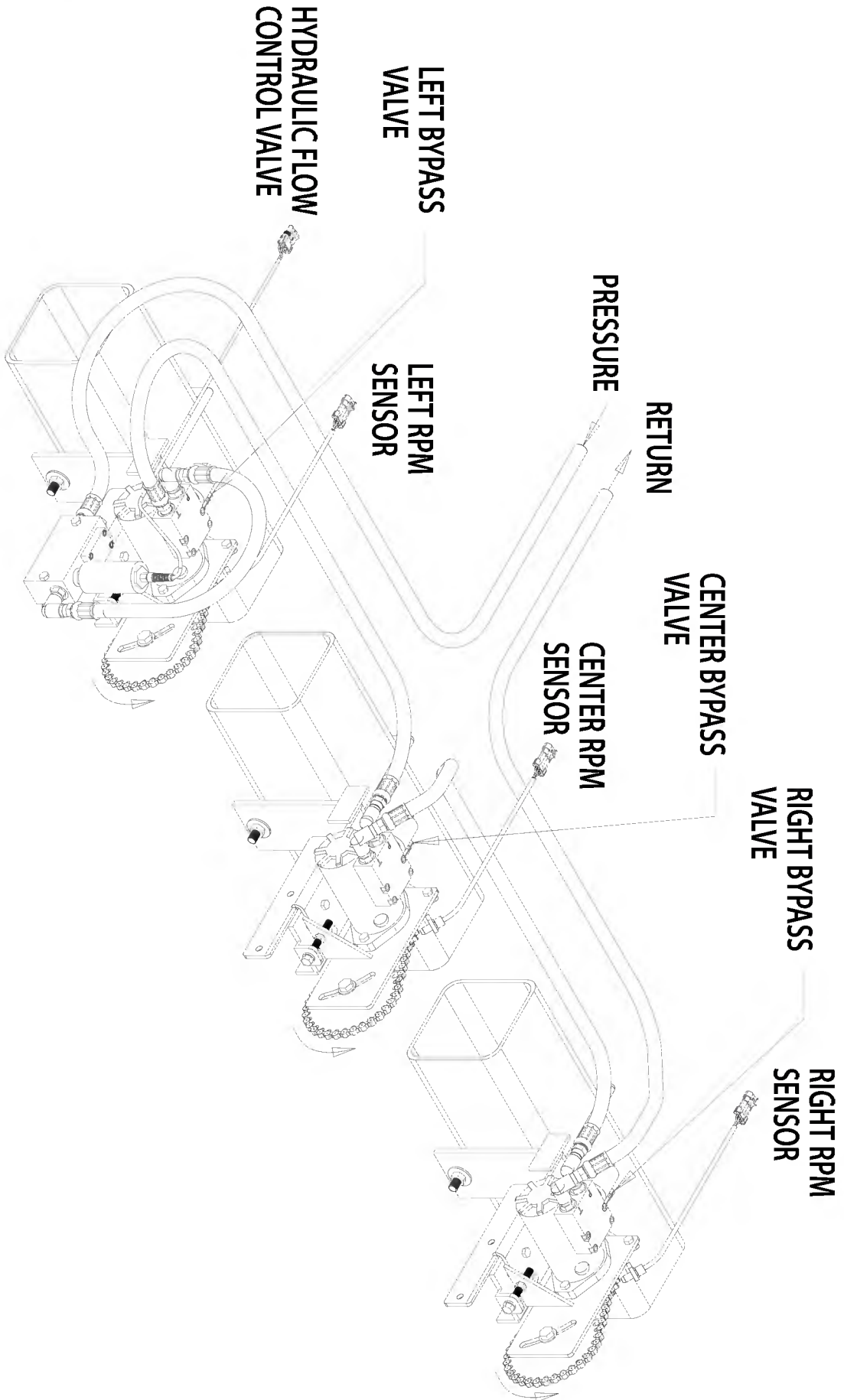

Multi- Drive Open Center Configuration

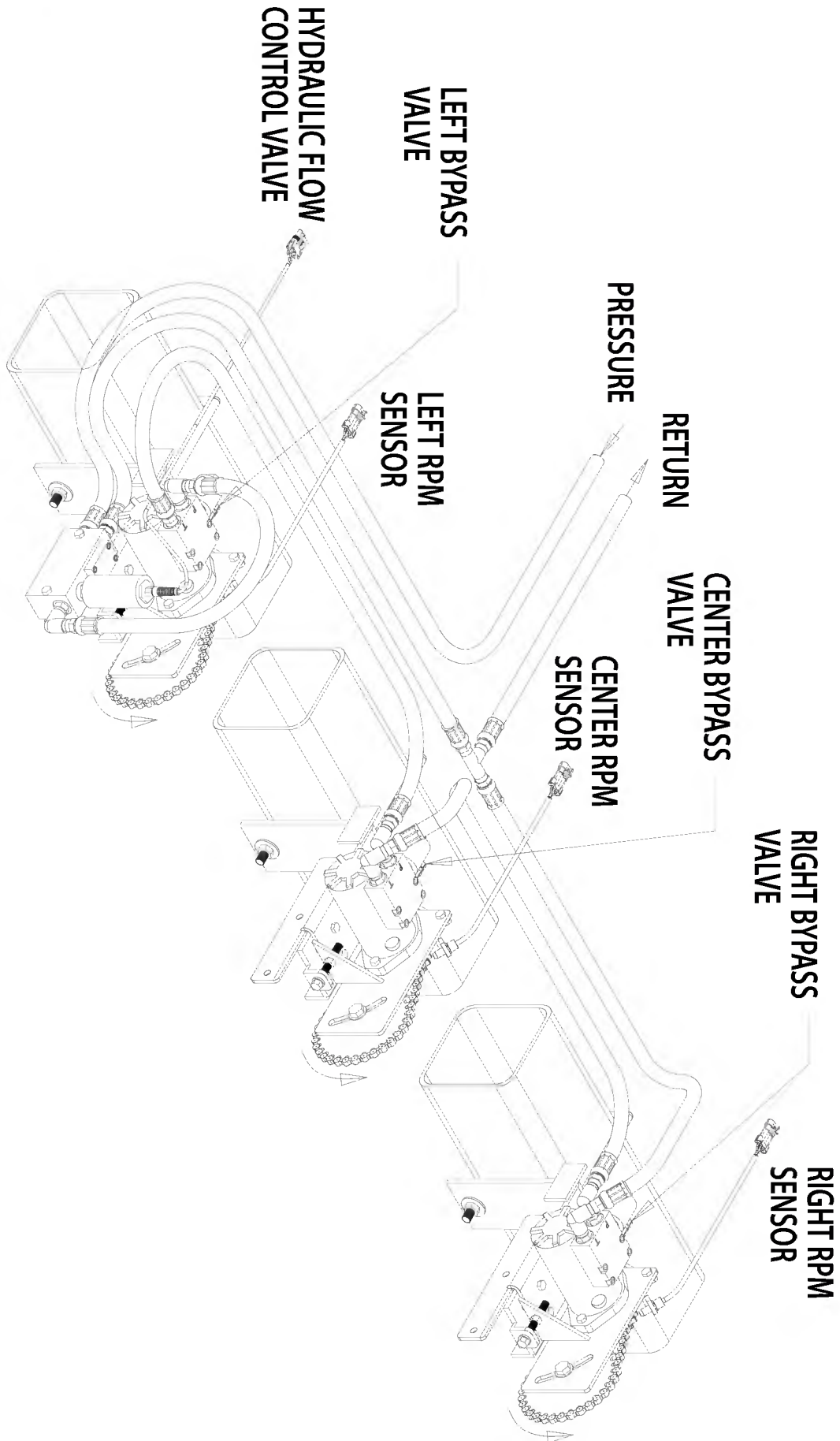

ProPlant™ Console Functions

The ProPlant features two large, easy-to-read liquid crystal displays and a lighted panel for night use. The right-hand display always shows the application rate and the left-hand display shows data selected by the rotary switch. Press the On/Off button to turn console on or off.

SEEDS (1) (2) (3): Displays theoretical number of seeds planted since seed counter was last reset. Value in display represents 1000's of seeds. 3 sets of counters, select set you want via the "+" key.

RPM: Display RPM for the selected hydraulic motor.

SEED SPACING: Calculated distance between seeds in inches or centimeters.

SEEDS/DISTANCE: Calculated seeds per foot, number of seed in 12 inches or seeds per meter.

Calibration Positions

METERCAL: Seeds dispensed per revolution of seed meter.

ROW SPACING: Inches or centimeters between rows.

ADJUST RATE: Enter an amount of change in seed rate desired for on-the-go rate adjustment to target rate when in Auto. (thousands of seeds per acre (hectare))

TARGET RATE: Enter desired Target rate, thousands of seeds per acre or hectare.

AREA (1) (2) (3): Keeps a running count of the total acres (hectares) worked. 3 counters may be reset independently. (Note: SEEDS and AREA counters work in pairs, if AREA counter 1 is reset, it also resets SEEDS counter 1).

DISTANCE: Displays distance traveled in feet (meters). May be reset.

AREA/HOUR: Displays current work rate in acres per hour (hectares per hour).

SPEED: Displays ground speed in miles per hour (kilometers per hour).

Calibration Positions

ROWS/SECTION: Number of rows per section.

SPEED CAL: Used in calibration mode to enter the speed calibration number in inches (cm) per pulse.

METER CAL TEST: In this switch position, the value displayed represents

the number of seeds dispensed in 5 revolutions of the seed meter, and can not be adjusted.

TEST SPEED: Used in calibration mode to enter a test speed in miles per hour (kilometers per hour).

RUN/HOLD SWITCH: Selecting the RUN position will turn on all active sections for AUTO or MANUAL control operation. (Section switches must be in the up (ON) position.) Selecting the HOLD position will shut off all active section valves. (Section switches may remain in the up (ON) position.) The HOLD position is the master hold for the system. It will override a RUN condition from any remote run/hold switches connected to the system.

SECTION SWITCHES: The console accumulates area based on the calibrated section widths. When an individual section is turned OFF, the respective width is subtracted from the total width to accumulate area based on the new active planting width. If a section switch is ON (up), its respective hydraulic motor should be on. If a section switch is OFF (down), its respective hydraulic motor should be off. No hydraulic motor should be ON if the Run/Hold switch is in HOLD, or in RUN and AUTO while speed is zero.

RATE (1) (2) (3): The operator can select one of three pre-programmed "Rates-on-the-go" while in Auto.

NOTE: When you "DELTA" the target rate, the display will momentarily show you the new target rate and then resume showing the actual seed rate.

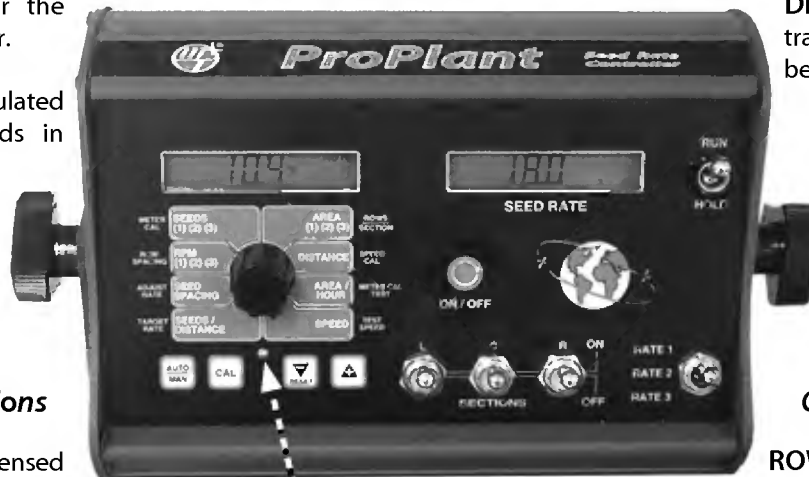



WARNING LIGHT: Indicates over or under application of plus or minus 10% from the Target Rate. Also lit when in CAL.

Key Functions:





ON / OFF

ON/OFF: Press to turn the console ON or OFF. Left-hand display shows hours of operation for 1 second, then software part number for 1.5 seconds, then version number before beginning normal operation.

AUTO/MAN: Key changes operation from automatic control to manual.

CAL: This key is used to enter & exit the calibration mode.

PROGRAM KEYS: Used to increment and decrement the different calibration values.

- RESET when not in CAL, clears the selected counter when held for two seconds.
- When in CAL, the "+" key increases and the "-" decreases the value displayed.

Calibration - Loading Default Calibration Values

English or Metric?

The ProPlant is capable of displaying information in American English or standard Metric measurement. The ProPlant is shipped from the factory programmed for English. **NOTE:** The following procedures will also load factory default calibration values. To simply change units without loading defaults, see the “Special Calibration” section.

METRIC

- You must be in HOLD or have all sections OFF to enter Cal. To activate the Metric mode, turn power OFF and place the rotary switch at “AREA.” Hold down both the “CAL” and “-” keys and turn power ON. See Illustration 11. The console will display LOAd. Once LOAd is displayed, release the two keys. To “lock-in” Metric mode you must enter and exit calibration. Press and hold the CAL key until “CAL” icon appears on the display. The console is now in calibration and Metric mode is selected. Exit CAL by pressing and holding the “CAL” key until CAL disappears from the display (approximately 1 second). **NOTE:** You must exit CAL to lock in Metric units.

ENGLISH

- You must be in HOLD or have all sections OFF to enter Cal. To activate the English mode, turn power OFF and place the rotary switch in the VOLUME position. Hold down both the “CAL” and “-” keys and turn power ON. The console will display LOAd. Once LOAd is displayed, release the two keys. To “lock-in” English mode you must enter and exit calibration. Press and hold the CAL key until “CAL” lights on the display. The console is now in calibration and English mode is selected. Exit CAL by pressing and holding the “CAL” key until CAL disappears from the display (approximately 1 second). **NOTE:** You must exit CAL to lock in English units.

Entering Calibration Values

To enter or change any of the system’s calibration values, you must enter calibration mode. To enter calibration mode, STOP the vehicle, turn all sections OFF or put the console in HOLD and press and hold the CAL button until the “CAL” icon appears (approximately one second). (**NOTE: Calibration may be entered while moving, but it is not recommended to attempt calibration while the vehicle is moving.**) The console will remain in calibration mode, with the RED warning light illuminated until you exit calibration or turn power OFF.

Once in calibration mode, you may change any one, all, or none of the values, in any order.* To select a calibration position, simply turn the rotary selector to the desired position. Calibration positions are identified by the WHITE labeling on each side of the rotary selector. All values are entered and adjusted using the “+” and “-” buttons on the front panel.

*Test speed must be last.

Hold the “CAL” key again for 1 second to exit calibration. “CAL” will disappear from the display. **NOTE:** You must exit CAL to save changes.

Illustration 5

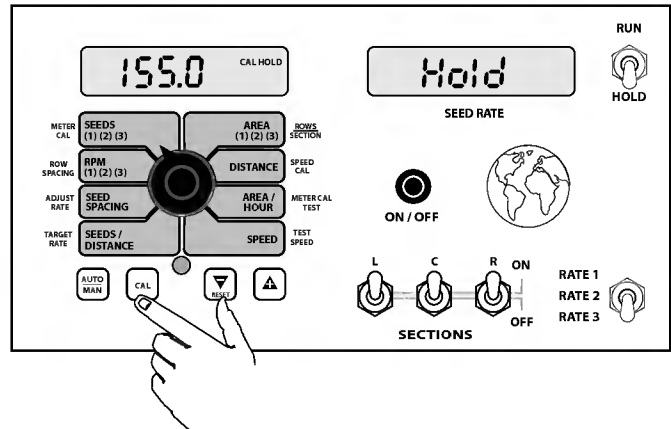

NOTE: In metric, the SPEED CAL will display 2 decimal places, in English it will display 3 places. Also, changing from English to Metric mode may change or alter any previously entered calibration values. After switching measurement modes, confirm that all calibration values are correct.

Illustration 6

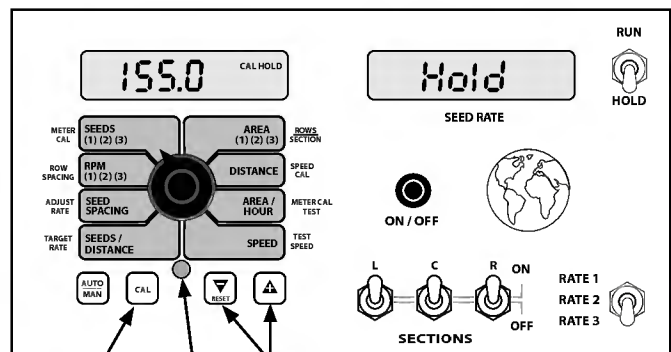

Press to enter or exit calibration mode.

Press to increase or decrease values.

Red warning light will be lit when in CAL.

Calibration (cont)

Entering Calibration Values (cont)

ROWS/SECTION: Enter the number of rows per section to match the actual. Toggle all three section switches ON. The value displayed is for the left section (Section 1). Adjust displayed value to match actual number of rows for section 1. Turn off the left section switch, the displayed value now is for the center section (Section 2). Now toggle off the center section switch, the display value is for the right section (Section 3). If your planter is configured as a single or dual section system, be sure to enter "0" for unused sections.

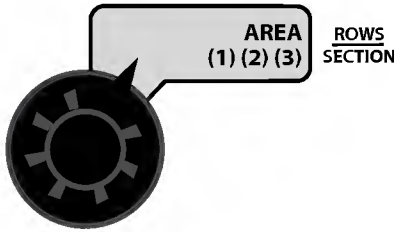

SPEED CAL: This position is used to calibrate the speed sensor for accurate speed and distance measurement. When this position is selected, the display will show the SPEED CAL value along with "CAL" on the display. See Illustration 7. In English units, the SPEED CAL number is displayed in inches, in metric it is displayed in centimeters.

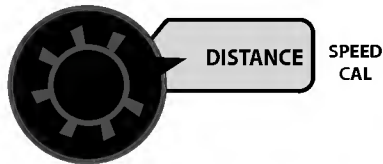

SPEED CAL FOR RADAR OR GPS SPEED SENSORS

See the following table for SPEED CAL numbers to enter for various radar models or GPS speed sensors. To fine tune the SPEED CAL number, see Appendix A on page 41.

Illustration 7

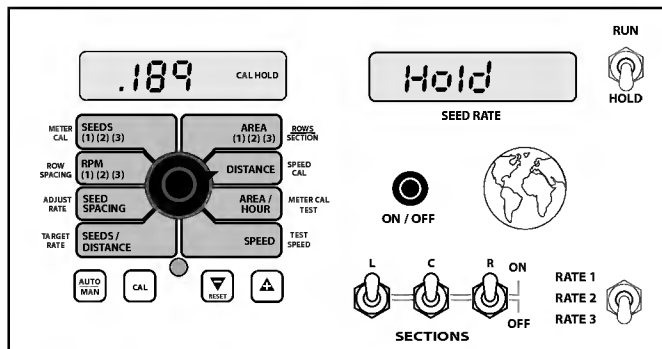

Radar Speed Sensor Calibration

Radars	English Cal # in.	Metric Cal # in.	Hz/ MPH
Vansco	.150	.38	58.90
Raven	.148	.38	59.80
Magnavox	.154	.39	57.40
Dickey-john (NOTE: Dickey-john radars may be factory calibrated for any of these four settings).	.149	.38	58.94
	.199	.50	44.21
	.319	.81	27.64
	.518	1.32	17.034

METER CAL TEST: Do not attempt to run the Meter Cal Test until all other calibration variables for both Special Cal and Standard Cal are complete. The value displayed in the Meter Cal Test position represents the Meter Cal value times 5. If the Meter Cal is set to 32, then the Meter Cal Test



value is 160 and is not adjustable. There are two methods for verifying the Meter Cal Test, the first is catch the seeds dispensed over the test period where the value displayed is the number of seeds you should expect to collect in one test cycle. The second method is to simply count revolutions of the seed meter of the test period; a successful test would result in 5 complete revolutions over the test period, The Rate the Meter Cal Test is run at is equal to a planting speed of 2.5 miles per hour, and the Seed Rate is equal to the Seed Rate setting selected, Rate 1, Rate 2 or Rate 3.

DANGER ALERT: Before proceeding to the next step be sure everyone is clear of the planter drive mechanism because the next step will start the drive motor.

To run the Meter Cal Test, toggle the Run/Hold switch to the Run position. The test will run until complete unless the Run/Hold switch is toggled to Hold at which time the test will terminate. It is a good idea to run the Meter Cal Test multiple times to positively verify results.

If the test is a success, you have successfully calibrated your ProPlant drive assembly, if not check the following settings:

1. In Special Cal, check the Ratio and Motor Cal settings for accuracy.
2. In Standard Cal, check the Meter Cal and Target Rate. The Target Rate selected needs to coincide with the Seed Meter setting.
3. Also be sure your hydraulic motor drive is running smoothly at the Target Rate selected for the test at 2.5 miles per hour. To verify this, see Test Speed.

GPS Speed Sensor Calibration

GPS Speed	English Cal # in.	Metric Cal # in.	Hz/MPH
Astro II & 5	.189	.48	46.56
SkyTrak	1.50	.38	58.94
Dickey-john	.210	.53	42.00
John Deere (In-cab spd signal)	.197	.50	44.70

Calibration (cont)

Entering Calibration Values (cont)

TEST SPEED: Test speed is a built-in ground speed simulator that is used in performing pre-field checks. When a typical operating speed is entered, the ProPlant will respond as if you were actually driving that speed. It allows you to simulate your seeding application, while remaining stationary, to make

certain that all of the equipment is operating properly and that your planter can actually perform the intended application. Test speed will not accumulate Distance or Area measurements. (The CAL indicator flashes to remind the user that TEST SPEED mode is active.) Hold the “+” button until the required speed is displayed. To exit Test Speed mode, exit CAL.

TARGET RATE: Enter your desired seed rate in thousands of seeds per acre or hectare. This is the seed rate that the console will lock onto when operating in AUTO. Example, if a value “32.5” is entered, the actual seed rate will be 32,500 seeds per acre or hectare. Locate the Rate switch in the lower right corner of the ProPlant console. A target seed rate can be entered for Rate 1, Rate 2 and Rate 3 for on-the-go rate change via the Rate toggle switch.

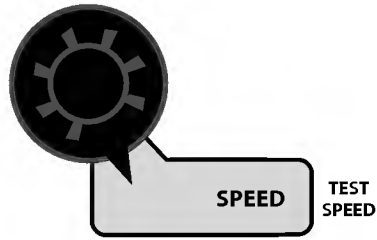

ADJUST RATE: Enter the value for the desired amount of change in thousands of seeds per acre (thousands of seeds/hectare) to be used for making on-the-go seed rate adjustments when operating in AUTO. For example, if a value “1.0” is entered, you will be able to increase or decrease your target seed rate in one thousand seed increments during operation in AUTO. To disable this feature, simply enter “.0”.



ROW SPACING: Adjust this value to match the spacing between rows. The default setting is 30 inches. The range is between 5.0 to 60.0 inches or 10.0 to 150 centimeters (metric).

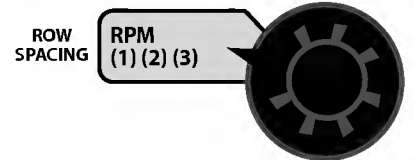

METER CAL: The meter cal value is the number of seeds dispensed per revolution of the seed meter disc or finger pick up.

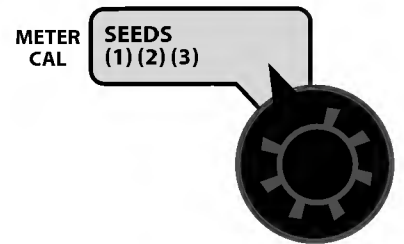

EXITING CALIBRATION: Upon completion of the calibration process, exit calibration by pressing and holding the CAL button until the RED warning light turns off (one second). Basic calibration is now complete. BEFORE beginning application, confirm that the system is set up to do the job that you want it to. **NOTE: You must exit CAL to save any changes.**

Factory-Loaded Calibration Values

Calibration Factor	Default Values	
	English	Metric
Speed Cal	.189 (in./edge)	48 (cm/edge)
Meter Cal	30 Seeds/Rev	30 Seeds/Rev
Row Spacing	30 Inch	50 cm
Section 1 (L) Rows	8 Rows	8 Rows
Section 2 (C) Rows	0 Rows	0 Rows
Section 3 (R) Rows	0 Rows	0 Rows
Target Rate 1	18.0 k SPA	40.0 k SPH
Target Rate 2	28.0 k SPA	70.0 k SPH
Target Rate 3	32.0 k SPA	80.0 k SPH
Adjust Rate 1	1.00 k SPA	10.0 k SPH

“Special” Cal	Default Values	
	English	Metric
Units	Eng	MEt
Valve Polarity	By-Pass	By-Pass
Control Speed	-1	-1
Startup Time	0 (Off)	0 (Off)
Auto Shut-off	Off	Off
Motor Cal	16 Pulse/Rev	16 Pulse/Rev
Ratio	4.000	4.000

“Special” Calibration

The “Special” calibration mode is used to set up system parameters that rarely need to be changed or adjusted. To enter Special Cal, put the system in HOLD, turn the console OFF, press and hold both the AUTO/MAN button and CAL button while turning console ON. The console will display SPEC for 2 seconds to show that the console is in the Special Calibration mode. Release the AUTO/MAN and CAL buttons. The CAL icon and Warn LED will turn on. The desired Special Calibration parameter(s) can then be accessed with the rotary switch per the illustration below. To exit Special Calibration, press and hold the CAL button for 2 seconds. The console will store any changes and revert to normal operation. **NOTE: You must exit Special Calibration to save changes.**

“Special” Cal

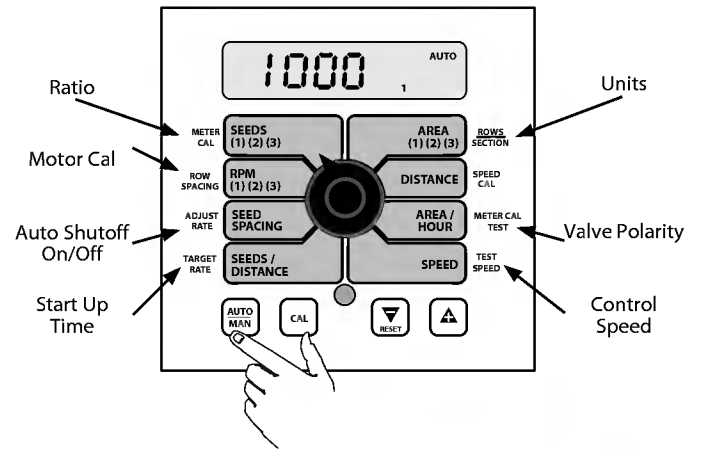

UNITS: Choose the system of units desired. Use the “+” and “-” buttons to choose between EnG (American English Units), or MET (Metric).

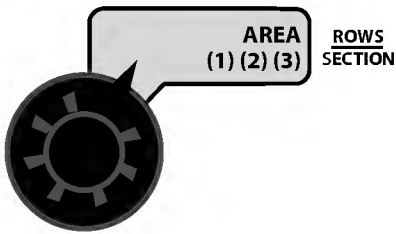

MOTOR CAL: Set this value to the number of pulses from the hydraulic motor per revolution. This is factory set to 16 and generally represents the number of teeth on the motor sprocket.

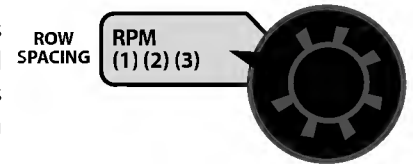

VALVE POLARITY: If the hydraulic motor RPM increases when the console is in Manual and the “-” button is pressed, change the valve polarity from Inline to Bypass or vice versa.



Auto Shutoff ON/OFF: When Auto Shutoff is enabled (ON), the hydraulic flow control valve will run towards minimum flow for 4 seconds anytime the system is put in Hold - or all sections are turned off, or if in auto mode and speed goes to zero.



CONTROL SPEED: This setting is factory defaulted to -1 and can be adjusted from -5 to 3. If the Control Valve is causing the Target Seed Rate to be unstable then reduce the valve control speed.

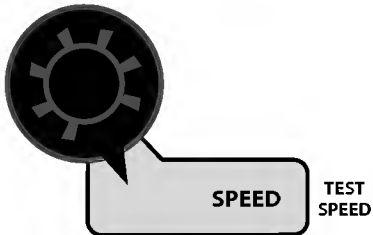

START UP: Start up time comes factory set to 0 and can be adjusted to 2048. This value represents the number of milliseconds the control valve will run each time the system is toggled from Hold to Auto. This setting should be set to 0 unless the Auto Shutoff is set to ON. Then increase the start up time to reduce the time to reach Target Seed Rate.



RATIO: Set this value to the ratio of hydraulic motor revolution to seed meter. It is factory set to 4.000. The value for Driven or Drive Sprocket refers to the number of teeth on the sprocket. See next page for “Calculating Ratio”.

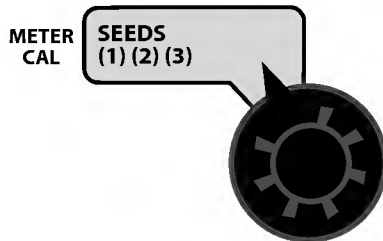

To exit Special Calibration, press and hold the CAL button for 2 seconds. The console will store any changes and revert to normal operation. **NOTE: You must exit Special Calibration to save changes.**

Operation

Make sure your system is properly calibrated before beginning your seeding operation. We also recommend completion of the Meter Cal Test described on page 31 prior to beginning any field operations.

Press the ON/OFF button to turn the console on. After displaying the hours of operation software part number then software revision number will be displayed.

The ProPlant can be operated in Manual (MAN) or Automatic (AUTO) mode. In either mode, the right-hand display will always show the Application Rate (except when in HOLD or when displaying error messages, see Troubleshooting section starting on page 36). The left hand display will show data as selected by the rotary switch.

Manual Operation

The manual mode is used when the operator wants to manually control the seed rate using the "+" and "-" keys. The seed rate (seeds/acre or seeds/hect) will vary depending on ground speed. Use the AUTO/MAN button to select MANUAL mode ("MAN" icon will be displayed).

IN HOLD: If the console is in HOLD, or if all Section Switches are OFF, the "+" and "-" buttons will not adjust the control valve.

IN RUN, WITH SPEED SIGNAL: If the system is in RUN, with at least one section switch ON and there is a speed signal, the "+" and "-" buttons can be used to adjust the control valve with the rotary switch in any position except SEEDS, AREA, DISTANCE or RPM and the seed rate can be monitored on the right-hand display.

IN RUN, NO SPEED SIGNAL: If there is no speed signal, "no SPEED" will flash in the right-hand display and the Seed Rate will be invalid. The "+" and "-" buttons will adjust the control valve if the rotary switch is in the SEED SPACING, SEEDS/DISTANCE, SPEED OR AREA/HOUR positions,

RPM INPUTS: Turn the rotary switch to RPM and select the RPM input of interest by pressing the "+" button, notice the

Turn rotary dial to display desired readout.

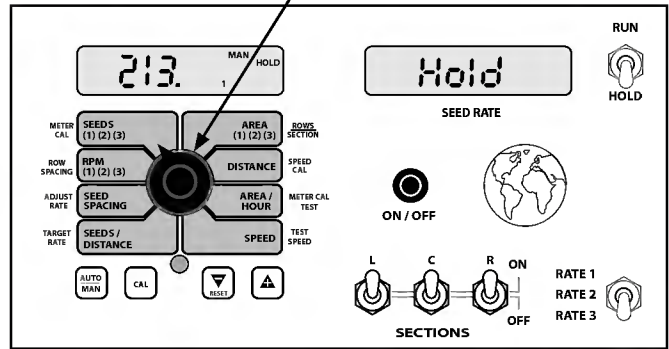

number change in the right display each time you press the "+" button. 1 represents the Left RPM input, 2 represents the Center and 3 the Right. Alternately you could toggle on only the Section switch whose input is in question and its associated number would be on by default if the console is in Run. The following test can be performed in either Run or Hold, if performed in Hold the Hold message will be replaced by ShAFt Err when you do the jumper wire test. left input is identified by two Brown cable ties, Center input has two Red cable ties and the Right input has two orange cable ties. See external wiring schematics starting on page 10 for more details.

1. Disconnect the input of concern
2. Using a voltmeter check for 12 volts between pins B (white wire) and C (black wire)
3. Check the voltage between pins A (red wire) and C, should be just over 9 volts
4. Using a jumper wire such as a paper clip bent in a "U" shape, rapidly short together pins A and C, this should produce an RPM reading at the console.

NOTE: If above tests are successful, then the input is working, see troubleshooting the sensors. If the tests above fail, then see external wiring schematics and perform same test further up the line towards console.

Operation (cont)

Automatic Operation

When the Automatic mode is selected, the console will control the control valve to maintain the desired seed rate SPA (SPH) when the vehicle speed changes or when sections are turned on or off. Press the AUTO/MAN button to select AUTOMATIC mode; the AUTO icon will appear in the display.

To operate the system in AUTOMATIC mode, turn on the desired section, toggle the RUN/HOLD switch to RUN, and drive.

IMPORTANT NOTE: In AUTO mode, when no speed signal is available, the system automatically turns all sections off. "no SPEED" will flash in the right-hand display until the vehicle starts moving, then the console will turn the sections on and the Seed Rate will be displayed in the right-hand display. The system will automatically adjust the control valve to maintain the calibrated TARGET RATE (SPA/SPH).

ON-THE-GO "DELTA" RATE ADJUSTMENTS (ADJUST RATE): To adjust the target seed rate on-the-go, each time the "+" or "-" buttons are pressed, the TARGET RATE will be increased or decreased by the amount of the ADJUST RATE which was entered in calibration. Example: calibrated TARGET RATE = 3.0 and ADJUST RATE = 1.0 pressing the "+" key once will increase the target rate from 30.0 to 31.0. The rate display will momentarily show the new target rate of 31.0 and then show the actual application rate. Pressing the "-" key once will decrease the target from 31.0 to 30.0. The new target rate is maintained until further adjustments are made using the "DELTA" feature or calibration changes occur, or if the unit is turned off. Important: to use the DELTA feature, the console must be in AUTOMATIC mode and the rotary switch can be in any position except RPM, SEEDS, AREA, or DISTANCE.

IN HOLD: If the system is in AUTO mode and in HOLD or all sections are off, the "+" and "-" buttons will adjust the TARGET RATE with the rotary switch in any position except RPM, SEEDS, DISTANCE or AREA.

Turn rotary dial to display desired readout.

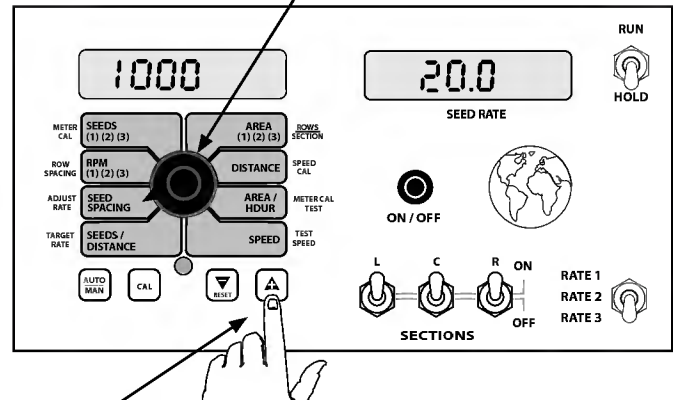

DATA DISPLAYED IN ROTARY SWITCH POSITIONS

SEED SPACING: Inches or centimeter between seeds

SEEDS (1) (2) (3): SEEDS/DISTANCE: Seeds per foot or
AREA (1) (2) (3): seeds per meter

Three independent pairs of counters. In either the AREA or the SEED position, select a pair of counters by pressing the "+" button. The active pair of counters (1,2,3) is indicated by the small numbers in the lower right corner of the left-hand display. DO NOT attempt to select the counter pair by using the "-" button because it will reset the selected counter pair to zero. See additional data description below and see **RESETTING SYSTEM COUNTERS** section.

SEEDS (1) (2) (3): Total seeds planted since the counter was last reset to zero.

AREA (1) (2) (3): The acres (hectares) covered since the counter was last reset to zero. The area counters do not accumulate area when the console is in HOLD or if all booms are turned OFF.

DISTANCE: The feet (meters) driven since the counter was last reset to zero. This counter does not accumulate when the console is in HOLD. This counter may be reset to zero independent of other system counters.

AREA/HOUR: Rate of coverage in acres/hour (hectare/hour).

SPEED: Ground speed in miles (kilometers) per hour.

IMPORTANT: All sections automatically shut off if system is in "HOLD" or if in AUTO with NO SPEED. The RPM can be monitored if the rotary switch is in the RPM position. The "+" button will change which motor RPM is being monitored when the rotary switch is in the RPM position.

Operation (cont)

Resetting System Counters

The AREA, DISTANCE and SEED counters maintain a running count during operation regardless of the position of the rotary switch. When any of these counters reach their maximum capacity, or when you want to start a new count, the value may be reset to zero by performing the following routine. Counter pairs may be reset independently of other counter pairs.

1. Turn the sections OFF or put the system in HOLD.
2. Turn the rotary switch to the counter to be reset.
3. To reset distance turn the rotary switch to DISTANCE and simply press and hold the RESET button until the display reads zero. The display will show the word "CLEAR" during this process, and will show 0.0 when reset to zero is complete.
4. To reset the seed and area counters; there are three independent AREA counters, paired with three SEED counters. The active pair of counters is indicated by the small numbers in the lower right area of the display (1,2, or 3) when the rotary switch is in the AREA or SEED position. Select the pair of counters you want to use by pressing the "+" button. The small number will increment each time the "+" button is pressed (from 1 to 3, then rolls back to 1). DO NOT attempt to select the counter number by using the "-" button, because that will clear the active pair of counters if held for 2 seconds. If the "-" button is accidentally pressed, the console will display "CLEAR" to alert the user that the counters will be cleared. If the user continues to hold the "-" button for 2 seconds "CLEAR" will disappear and be replaced by 0.0, indicating that the selected pair of counters has been cleared.

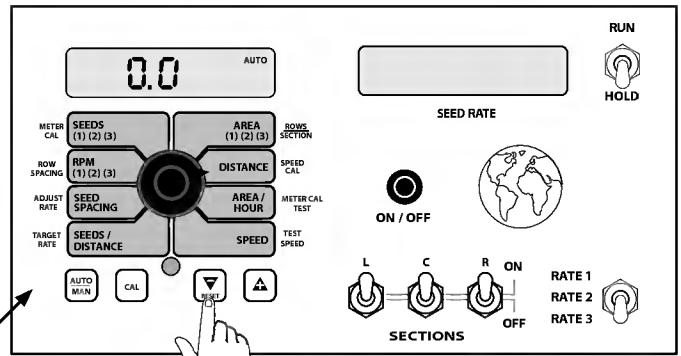

Display indicates counter pair #2 is selected

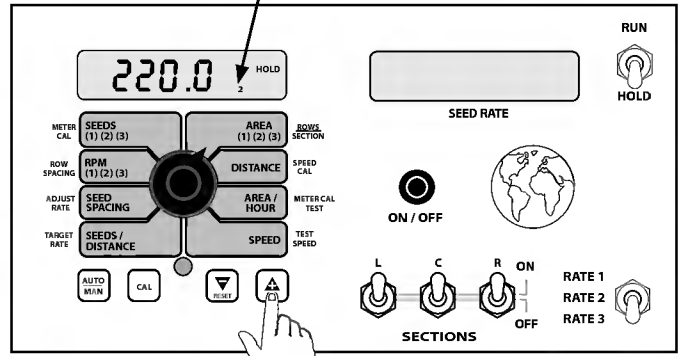

Display indicates counter pair #3 is selected

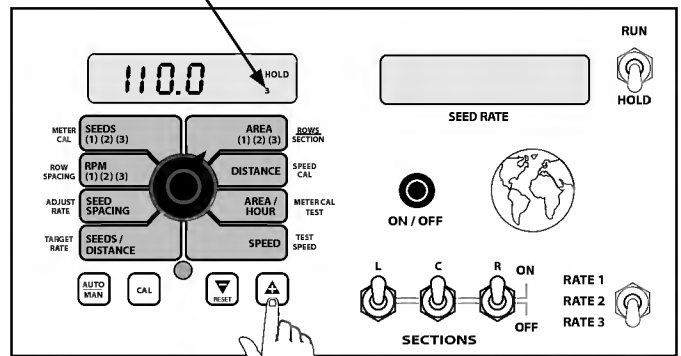

Display indicates counter pair #1 is selected

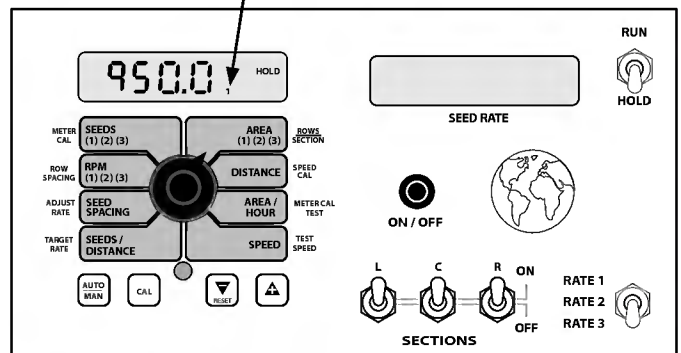

Clearing Counters

When the desired counter number is displayed, press the "-" (RESET) button and "CLEAR" will be displayed. **NOTE: holding the "-" (RESET) button for 2 seconds will clear both the #3 AREA counter AND the #3 SEEDS counter whether the rotary switch is in the AREA or the SEEDS position.** If the "-" button is released before 2 seconds have elapsed, the counters will not be cleared and the "CLEAR" message will be replaced with the previous total.

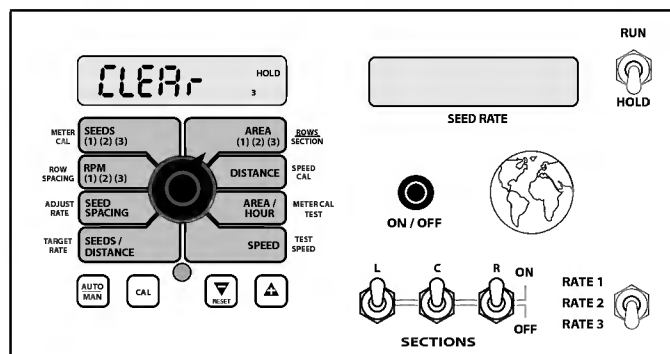

After the "-" (RESET) button has been held for 3 seconds, the "CLEAR" message will be replaced by 0.0, indicating that counter pair #3 has been cleared.



Troubleshooting Messages / Warnings

bAd ^{CAL}

If this message appears, it is strongly recommended to check/verify all calibration values before using the console. It indicates that there may have been a problem with storing calibration values. Cycling power will not clear the bad CAL message, it can only be cleared by entering and exiting calibration mode.

Lo P

Low Power. Check all power and ground connections. After OFF button is pressed and console powers down, this message is briefly displayed.

LoAd

Has loaded Default Cal factors (appears when default calibration factors are loaded by holding CAL and "-" buttons while turning the console on).

no SPEED

Will flash in right-hand display with rotary switch in ANY position if there is no Speed signal regardless of all other conditions. Check speed sensor and connections per Troubleshooting section.

ShAFt Err

Will flash in right-hand display with rotary switch in ANY position if there should be RPM (In Run, some sections on, speed greater than 0) but no RPM is detected, or if there is RPM but should not be. Check RPM sensor and wiring harness connections per Troubleshooting section.

no SEct

Will flash in left hand display if rotary switch is in Rows/Section position, system is in Cal mode and no section switches are turned on. Make sure system is in run and a section switch is turned on, also check Run/Hold switch or sensor and connections.

EStoP

The ShAFt Err message described above will flash for 5 seconds and if the ProPlant is in AUTO, the system runs the control valve in the open direction in an effort to generate an RPM signal. If it fails to, the system will run the control valve in the closed direction and display EStOP or Emergency Stop. Investigate and fix RPM signal problem, see Troubleshooting section - must go to HOLD and back to RUN to retry (or recycle power).

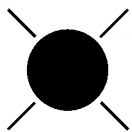

Warn LED flashes when the Rate error is over 10%. It is on steady when in CAL mode or SPECIAL CAL mode or Test Speed

SPEC

Special Calibration mode is active. Appears when entering Special Calibration mode (hold AUTO/MAN and CAL buttons while turning console on).

v

The "v" icon in the right-hand display indicates that token has been inserted and system is ready for VRA operation.

CLEAR

The message alerts the user that the currently selected counter will be cleared if held for 2 seconds. Also serves as a reminder to use "+" button to select counters.

OFL

Counters (DISTANCE or AREA or SEEDS) have overflowed their maximum. RESET (see page 35) to clear counters and resume counting.

Troubleshooting (cont)

General

All ProPlant consoles, motor and control valves are tested prior to packaging, so unless there has been damage in shipment you can be confident that everything will be operational when you receive it.

However, if you do encounter a problem that appears to be related to equipment failure, **PLEASE DO NOT OPEN THE CONSOLE**. Your system is protected by a warranty, and Micro-Trak will gladly correct any defect.

Many problems are the result of mistakes in installation or operation. Before returning any parts for service, carefully check your installation and review the operating instructions. For easy-to-follow guidelines, refer to the troubleshooting section which follows.

CONSOLE APPEARS DEAD

- Using your test light, check for 12 volts at the power source. Also check for damaged power cable or reversed terminals. (Console requires 12 volts for proper operation). Check connections of ignition or power switch.

SPEED IS ALWAYS ZERO OR ERRATIC

- Check for properly calibrated wheel circumference.
- Review speed sensor installation. Check for proper mounting, alignment and spacing of speed sensor in relationship to magnet assembly. Make sure magnet polarities are alternated. Also check cable for breaks or incomplete connection. **For more suggestions on solutions to speed problems see page 39.**

DISTANCE COUNT IS INACCURATE

- Speed Cal was incorrectly entered. Review calibration, re-adjust and test.

AREA COUNT IS INACCURATE

- Implement width or wheel circumference was measured incorrectly or programmed incorrectly. Go back through the original procedures, make changes, and test for acre (hectare) count again. (Make sure no width is entered for unused sections.) Verify accuracy with formula:

$$\text{Acres} = \text{Distance} \times \text{Width in feet} / 43560$$
$$\text{Hectares} = \text{Distance} \times \text{Width in meters} / 10,000$$

SECTION SHUT-OFF

- If you are in AUTO with no speed, the section motors will shut-off.

CONSOLE IS ERRATIC IN OPERATION

- If you have a two-way radio, it may be mounted too close to the console. Keep all ProPlant cables away from the radio, its antenna and power cable.
- Ignition wires may be causing the console to malfunction. Keep ProPlant cables away from ignition wires, or install ignition suppressor.
- Reroute all cable away from electric solenoids, air conditioning clutches and similar equipment.
- Check the CONTROL SPEED calibration number in Special Calibration. If the RATE tends to overshoot or oscillate, the CONTROL SPEED setting may be too high for the control valve being used; reduce the VALVE SPEED setting by 1 (range is -5 to +3).

DISPLAYED MEASUREMENTS DO NOT MAKE SENSE

- The console may be in the incorrect measurement mode (English or metric). *See page 29 for instructions.*

DISPLAY READS "OFL"

- DISTANCE, AREA, and SEEDS counters read OFL when they have exceeded their maximum count. Reset to zero to resume counting.

SYSTEM OPERATION (CONTROL) IS SLUGGISH IN AUTOMATIC MODE

- Check the CONTROL SPEED setting in Special Calibration. If using a slow valve (4 seconds or more, open to close) increase the VALVE SPEED setting.

Troubleshooting (cont)

Checking Individual Components

CONSOLE

- The only way to field test a console is to connect it to a harness on a vehicle with a known working console or install it on an E-POP (Electronic Point of Purchase) display stand.

HARNESS

- The harness can be checked using an ohmmeter or continuity tester. The main wiring diagram shows the pin out of all connectors.

ELECTRICAL INTERFERENCE

- Erratic operation of the system may be the result of electrical interference from ignition wires or inductive loads (electrical clutch, fan, solenoid, etc.). Always try to route wires as far away from suspect areas as possible. If problems occur, you may need to relocate the console and/or wiring harness, or install a noise suppressor.

POWER

- Check power source with the MT-101 tester or a test light. If there is no power, trace cable toward battery looking for breaks. Also check any fuses or circuit breakers that supply power to the console.

ACCESSORY POWER

- The speed, RPM and run/hold cables all have an accessory power wire. Check for 12 volts between B (usually white) and C (usually black) of these connectors. If power is not present, make sure the accessory power wire is not open or shorted to ground or to another wire. If this wire has a problem, the console may exhibit erratic behavior or not function at all.

VANSCO RADAR SPEED SENSOR

Carefully check your installation and operating instructions. The following are tips for troubleshooting;

1. Disconnect the radar adapter cable from the console harness.
2. Check for 12 VDC between pins B and C of the main harness connector (yellow tie). If not present, console or harness may be defective.
3. Using a jumper wire (paper clip bent into a "U"), rapidly short together positions A and C of the main harness speed connector (yellow tie) several times. The console should respond with some speed reading. If not, the console or harness may be defective.
4. Reconnect the radar adapter cable to the main harness speed connection (yellow tie).
5. Disconnect the radar from the radar adapter cable.
6. Check for 12 VDC between pins 1 and 3 of the radar adapter connector. If it is not present but was present in step 2, the radar adapter cable may be defective.
7. Using a jumper wire (paper clip bent into a "U"), rapidly short together positions 2 and 3 of the radar connector (round 4-pin) several times. The console should respond with some speed reading. If not but had a reading in step 3, the radar adapter cable may be defective.
8. If system passes all above tests, the radar may be defective.

TROUBLESHOOTING THE SENSOR, SPEED, RUN/HOLD AND PROXIMITY SENSORS

CAUTION: Improper connection or voltage could damage the sensor.

1. Disconnect the sensor in question from the input
2. Connect +12VDC to pin B
3. Connect pin C to Ground
4. Using a voltmeter set to ohms, connect one lead to pin A and the other to Ground
5. Holding the tip of either the Speed or Run/Hold sensor up to the north pole of a magnet (non-perforated side of a Micro-Trak magnet) the meter should read a very high resistance, while holding the tip of the sensor up to the south pole should result in a very low resistance (around 300 ohms). The proximity or gear tooth sensor works much the same only instead of using a magnet you would test with a large bolt or other ferrous metal object. Holding the sensor tip away from ferrous metal object will give a very high resistance reading while holding the sensor tip close to a ferrous metal object will result in a low resistance reading (around 50 ohms).

Also check for proper distance between the tip of the sensor to target complies with the following:

- Speed Sensor (green sensor) tip to magnet spacing should not exceed 1/2"
- Run/Hold (black sensor) tip to magnet spacing should not exceed 1/2"
- Proximity or gear tooth Sensor tip to ferrous metal object (gear tooth) should not exceed 1/8"

If the sensor fails the above test, replace sensor, if not test sensor input to controller.

MOTOR BYPASS VALVE

To test the solenoid coil, measure the resistance across the two terminals in the connector, a good solenoid coil will measure between 6.8 and 10.8 ohms. If the resistance is either much lower or higher, replace the solenoid coil. If the resistance tests ok and the Section Bypass Valve output tested good, then remove the solenoid coil from the cartridge stem by removing the 11/16" nut. Slide the coil off the cartridge stem to expose the 1" hex at the base of the cartridge. Remove the cartridge and inspect O-rings for damage. The internal moving part of the cartridge should move freely up and down, this plunger will be moved up in the cartridge by the flow of hydraulic oil and when the solenoid coil is energized, the plunger is forced down closing the valve thus diverting the oil flow through the motor. If the plunger will not move, remove the O-rings and submerge the cartridge in solvent in an attempt to remove foreign material causing the plunger to bind. If successful, allow cartridge to dry then replace O-rings and dip cartridge in clean oil prior to assembly. If unsuccessful, replace cartridge. Screw cartridge in by hand until the top O-ring is met, then wrench tighten to 25-27 ft.-lbs. Slide solenoid coil onto cartridge stem and tighten 11/16" nut to 7-10 ft.-lbs.

Troubleshooting (cont)

Checking Individual Components (cont)

HYDRAULIC FLOW CONTROL VALVE

- Disconnect valve from output and inspect the wire from the connector to the motor housing for possible shorted or open wires. Connect +12VDC and ground across pins B and C of the control valve connector, if the valve does not run reverse the connections. The valve should run approximately 3.5 seconds each time you reverse the connections. If the aforementioned test is successful then you need to test the Control Valve Output. If not, then send control valve in for repair or replacement.

Troubleshooting Console Inputs & Outputs

SPEED INPUT

Turn the rotary switch to the Speed position and perform the following procedure:

1. Disconnect the Speed sensor (yellow tie)
2. Using a voltmeter check for 12 volts between pins B (white wire) and C (black wire)
3. Check the voltage between pins A (red wire) and C, should be just over 9 volts
4. Using a jumper wire such as a paper clip bent in a "U" shape, rapidly short together pins A and C, this should product a Speed reading at the console.

If the above tests are successful, then the input is working, see Troubleshooting the Sensors. If tests above fail, then see external wiring schematics starting on page 10 and perform same test further up the line towards console.

REMOTE HOLD INPUT

See schematic on page 19 to learn where to locate and identify the remote Run/Hold input connector.

1. Disconnect the Run/Hold sensor.
2. Using a voltmeter, check for 12 volts between pins B (white wire) and C (black wire).
3. Check the voltage between pins A (red wire) and C, should be just over 9 volts.
4. Using a jumper wire such as a paper clip bent in a "U" shape, short together pins A and C, this should cause the Hold message to be displayed in the Seed Rate display of the console if the Run/Hold switch is in the Run position.

If above tests are successful, then the input is working, see Troubleshooting the Sensors. If tests above fail, then see external wiring schematics and perform same test further up the line towards console.

CONTROL VALVE OUTPUT

To test the Control Valve Output, perform the following procedure:

1. Set operating mode to Manual (MAN).
2. Toggle the console Run/Hold switch to Run. If the Remote Run/Hold input is causing the console to remain in Hold, disconnect the remote sensor.
3. Toggle at least one Section switch on.
4. Turn the rotary switch to anything but Seeds, Area or RPM.
5. Connect a voltmeter or DC test light between pin B of the Control Valve connector and C of the closest RPM sensor input. It should measure 0 volts.
6. Have someone press the "+" button for about 5 seconds then the "-" button for 5 seconds while you observe the meter. The voltmeter should have pulsed toward 12 volts or the test light should have pulsed on during the 5 second period of one or the other. If the meter pulsed toward 12 volts only when the "+" button was pressed, then in step 8 the opposite will occur.
7. Now move the connection from pin B of the Control Valve to connector C.
8. Have someone press the "+" button for about 5 seconds then the "-" button for 5 seconds while you observe the meter. The voltmeter should have pulsed toward 12 volts or the test light should have pulsed on. If in step 6 the voltmeter responded to the "+" and not the "-" button, then in this test the results should be opposite.

If the above test was successful, then the output is good and you need to test the Control Valve. If the test failed, then see the external wiring schematics and perform the same test further up the line towards the console.

SECTION BYPASS VALVE OUTPUTS

To test the Section Valve outputs, follow the directions below. *To assist identifying inputs of interest, see external wiring schematics starting on page 9.*

1. Toggle the console to Run and toggle all section switches off, the rotary switch can be in any position. If the remote Run/Hold input is causing the console to remain in Hold, disconnect the sensor.
2. Disconnect the output in question from valve.
3. Using a voltmeter or test light connect one lead to A and the other to B.
4. The voltmeter or test light should be 0 volts or off while the section switch is off and 12 volts or on when the section switch is on.

The above test was good then the output is working and you need to test the Motor Bypass Valve.

Appendices

Appendix A

Fine Tuning Speed/Distance Calibration Value

This procedure is used to verify the speed/distance calibration. In order to achieve accurate measurements, each step in this fine tuning procedure should be performed as precisely as possible.

PREPARATION

- Once the system is fully installed and calibrated, select a straight tract of ground that is similar to your actual field conditions and as level as possible.

NOTE: Using a course with a different ground surface, such as a hard-surface road, will result in different readings than exact field conditions.

- Measure a distance of 1000 feet (500 meters). Clearly mark the beginning and end points with flags or something highly visible to the operator.

PROCEDURE

- With the console turned ON, place the Run/Hold switch in the HOLD position. The HOLD icon will be displayed. Turn the rotary dial to the "DISTANCE" position. Be sure the display shows 0. If not, reset the distance counter by pressing and holding "RESET" until the display returns to 0 (approximately one second). The word CLEAR will be displayed when reset is pressed.
- You are now ready to drive the measured course. Pick a location on the vehicle to use as a marker for starting and stopping the distance counting function (door handle, mirror, step, etc.). You should begin driving the course well ahead of the starting flag and drive past the ending flag, using the Run/Hold switch to start and stop the counting function. It is not recommended to start from a dead stop at the starting flag and stop at the ending flag.
- Place the Run/Hold switch in RUN when the marker on the vehicle passes the starting flag to activate the distance counting function. The console display numbers will increase, adding to the distance total as you drive. Drive the pre-measured course and place the Run/Hold switch in HOLD, when the marker on the vehicle passes the ending flag, to stop the distance counting function. The console display should read "HOLD". *See Illustration to the right.* Stop the vehicle in a level and safe area and continue with this procedure.

- With the rotary dial still at DISTANCE (SPEED CAL), press and hold the "CAL" key for one second. Once the console is in "CAL," CAL and the speed calibration value will be displayed. Momentarily press CAL and the word CAL will begin to flash and the distance travelled will be displayed.
- When the display shows distance ("CAL" is flashing), verify whether the number displayed is the exact distance you drove (within +/- 1 - 2 %). If not, press the "+" or "-" key to adjust the figure to match the distance you actually drove. If the display reads too high, use the "-" key to lower the displayed value. If the display reads too low, use the "+" key to raise the displayed value.
- When the number shown on the display matches (as closely as possible) the actual distance driven, you have arrived at the correct calibration value. If you cannot adjust the displayed distance to exactly match the actual distance driven, adjust the figure as close as possible to the actual distance. You may check the calibration number by momentarily pressing CAL. The word CAL and the SPEED CAL number will appear. Exit "CAL" by pressing "CAL" for one second.

The speed sensor is now calibrated. To verify proper calibration, repeat the procedure a second time. Write down the new speed calibration number and keep it in a safe place. If the calibration values are ever accidentally changed, you can simply re-enter this number.

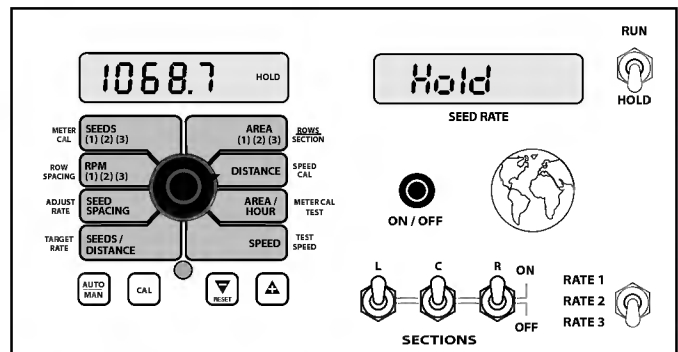

Appendix B

Radar Adapter Cables

In-Cab John Deere Metri-Pack Connector
8000/9000 Series

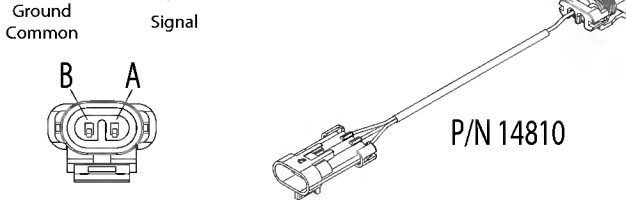

RADAR	CONNECTOR	SIGNAL PIN
DICKEY-john	Amp	2
DICKEY-john	Cannon	3
DICKEY-john	Deutsch	3
DICKEY-john	Ford	2
DICKEY-john	Packard	B
In-Cab JD (8000 & 9000's)	Metri-Pack	A
Magnavox & Phillips	Packard	C
Raven	Conxall	3
Vansco	Amp	2

DICKEY-john Radar Amp Connector

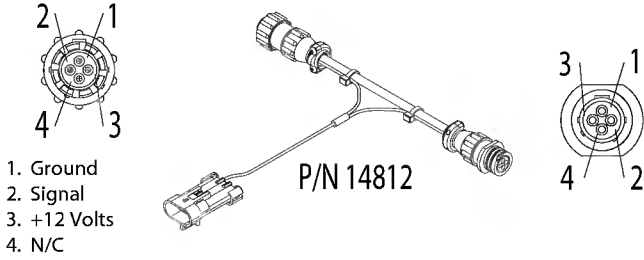

In-Cab John Deere "Y" Connector

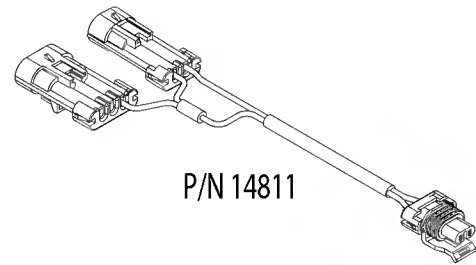

DICKEY-john Radar Cannon Connector

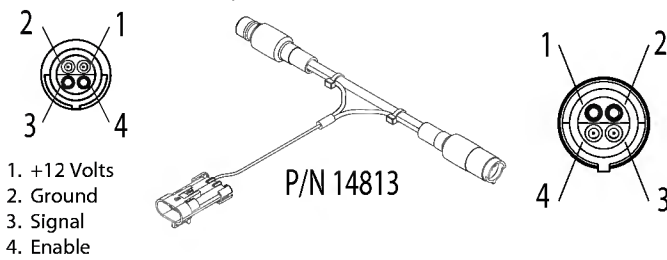

DICKEY-john Radar Packard Connector

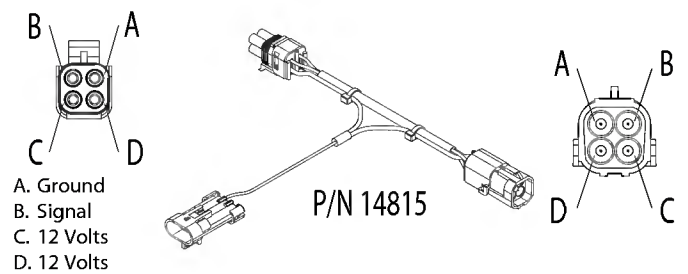

DICKEY-john Radar Deutsch Connector

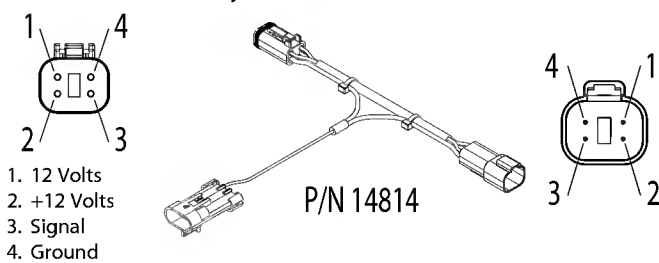

Magnavox & Phillips Radar Packard Connector

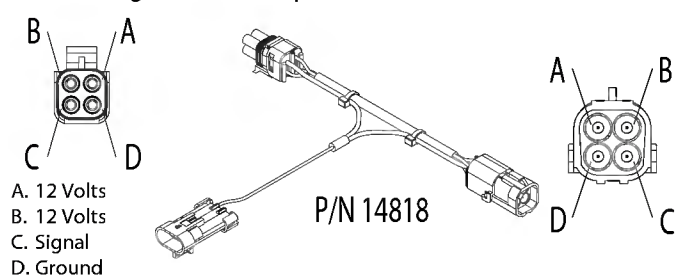

DICKEY-john Radar Ford Connector

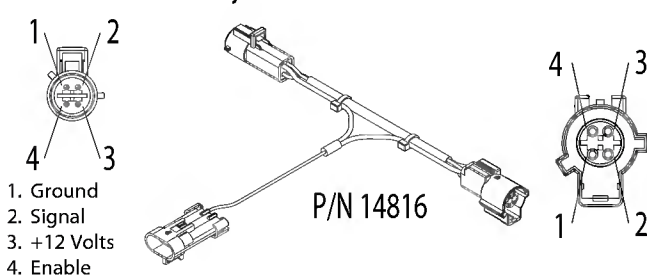

Raven Radar Conxall Connector

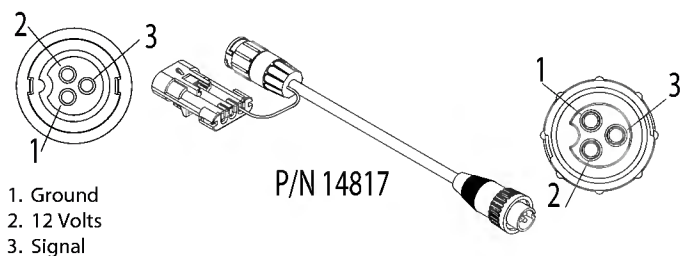

Vansco Radar Amp Connector

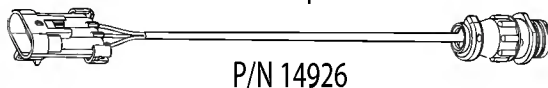

Appendix C

Conversion Chart

English to Metric		
When You Know	Multiple By	To Find
LINEAR MEASUREMENT		
inches	25.4	millimeters
feet	0.305	meters
yards	0.914	meters
miles	1.61	kilometers
LAND MEASUREMENT		
square inches	645.16	square millimeters
square feet	0.093	square meters
square yards	0.836	square meters
acres	.405	hectares
square miles	2.59	square kilometers
LIQUID MEASUREMENT		
fluid ounces	29.57	milliliters
pint	0.473	liters
quart	0.946	liters
gallons	3.785	liters
VOLUME		
cubic feet	0.028	cubic meters
cubic yards	0.765	cubic meters
DRY MEASUREMENT		
quart	1.101	liters
peck	8.810	liters
bushel	35.239	liters
FUEL CONSUMPTION		
10 miles per gallon = 4.25 kilometers per liter		

Metric to English		
When You Know	Multiple By	To Find
LINEAR MEASUREMENT		
millimeters	.039	inches
meters	3.28	feet
meters	1.09	yards
kilometers	.62	miles
LAND MEASUREMENT		
square millimeters	0.00155	square inches
square meters	10.764	square feet
square meters	1.195	square yards
hectares	2.47	acres
square kilometers	0.386	square miles
LIQUID MEASUREMENT		
milliliters	0.034	fluid ounces
liters	0.529	pint
liters	0.264	quart
liters	2.64	gallons
VOLUME		
cubic meters	35.314	cubic feet
cubic meters	1.307	cubic yards
DRY MEASUREMENT		
liters	1.101	quart
liters	8.810	peck
liters	35.239	bushels
FUEL CONSUMPTION		
10 kilometers per liter = 23.5 miles per gallon		

Conversion Abbreviations

Symbols	Symbols	Symbols
in. = inches	pt. = pint	km = kilometers
ft. = feet	qt. = quart	mm ² = square millimeters
yd. = yards	gal. = gallon	m ² = square meters
mi. = miles	ft ³ = cubic feet	ha = hectares
in ² = square inches	yd ³ = cubic yards	km ² square kilometers
ft ² = square feet	pk. = peck	ml = milliliters
yd ² = square yards	bu. = bushel	l = liters
mi ² = square miles	mm = milliliters	dal = dekaliters (10 liters)
fl oz. = fluid ounces	m = meters	m ³ = cubic meters

Appendix D

Replacement Parts List

The following replacement parts are available from your dealer or distributor. To find your nearest dealer or distributor, visit www.micro-trak.com or call Micro-Trak at 1-800-328-9613.

Micro-Trak Systems, Inc.
 P.O. Box 99, 111 East LeRay Avenue
 Eagle Lake, MN 56024-0099

When ordering parts, please list the model number of your console, and the description and part number of each part that you want to order.

<u>Part Number</u>	<u>Description</u>
12910	14" Black plastic cable ties (bag of 10)
13774	Console Mount Kit*
10423	Console Mount Knob
10470	Console Mount Washer
13226	5-foot Remote Run/Hold Sensor Cable
17329	Reference Manual
17339	15' Power and Section Valve Console Harness (Section 180", Power Harness 240")
14324	Adapter Speed Cable (36")
13270	Terminal Kit w/Fuse Holder
17359	20' Flow, Servo, Run/Hold Harness (one section)
17358	20' Section Harness (one section)
17360	15' Flow, Servo, Run/Hold Console Harness
17307	20' Section Branch Harness (sections 1-3)
17308	20' Flow, Servo, Run/Hold Branch Harness (sections 1-3)
17320	Tool Bar Bracket
17321	Motor Bracket
17370	Serial Memory Token (for VRA)
17397	Gear Tooth Sensor Kit
17351	7" U-Bolt
17395	Bolt/Fastener Kit
17390	#40 Chain Kit
17399	Primary Drive Fitting Kit
17398	Secondary Drive Fitting Kit

Optional 3-Pin, 5-Pin and 10-Pin Metri-Pack 150 extension cables and 3-Pin Weather-Pack extension cables:

Part No.	M/P 3-Pin	Part No.	M/P 3-Pin	Part No.	M/P 10-Pin	Part No.	W/P 3-Pin
13205	5-foot	14482	5-foot	13220	5-foot	10450	5-foot
13206	10-foot	14483	10-foot	13221	10-foot	10449	10-foot
13207	15-foot	14484	15-foot	13222	15-foot	10876	15-foot
13208	20-foot	14485	20-foot	13223	20-foot	10829	20-foot
13209	25-foot	14486	25-foot	13224	25-foot	11462	25-foot

*The Console Mount Kit is available only as a kit, some parts are not available in individual components.
 Parts and design specifications subject to change without notice.

Appendix E

VRA (Variable Rate Application)

To perform Variable Rate Application, a token (Micro-Trak P/N # 17370) must be inserted into the back of the ProPlant console, as shown. (Remove the label covering the socket. Turn power off before inserting or removing the token.)

NOTE: The “v” in the right hand display on the front of the console will be ON if token is inserted properly and has been recognized.

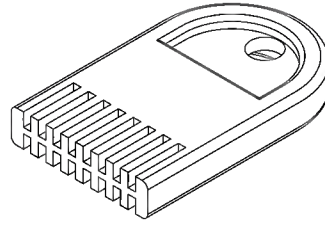

Serial Memory Token
(For VRA)
P/N # 17370

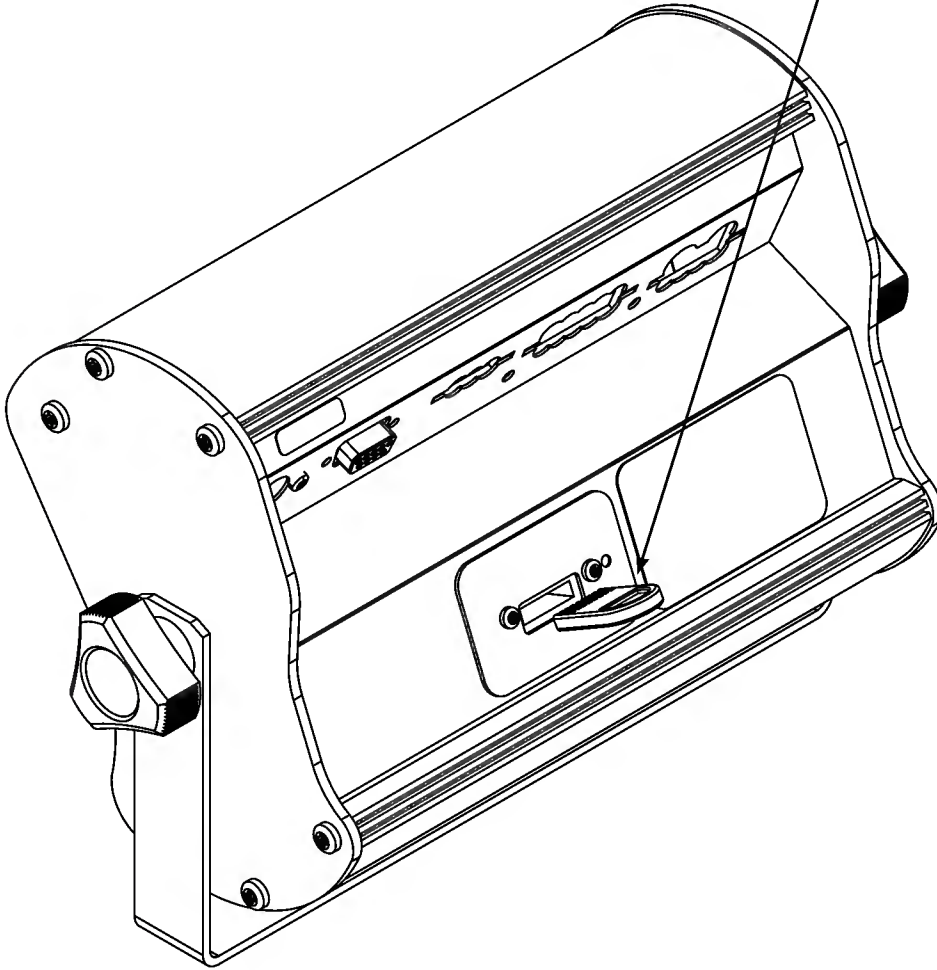

MANUFACTURED IN U.S.A. BY:



111 E. LeRay Avenue • P.O. Box 99 • Eagle Lake, MN 56024-0099

Toll Free: (800) 328-9613 • (507) 257-3600 • Fax: (507) 257-3001

www.micro-trak.com • trakmail@micro-trak.com

© 2007 Micro-Trak Systems, Inc. • Printed in U.S.A.