



Farm, Horticulture and Garden Equipment

www.massanosnc.com

USE AND MAINTENANCE BOOK

REVERSE TILLER TYPE FRANGITER RSE PLUS.2



MASSANO snc Frazione Cavallotta – Via Costigliole 4 – 12038 SAVIGLIANO (CN) - Italy

Tel (+39) 0172 – 377167 Fax (+39) 0172 – 377014

www.massanosnc.com E-mail: info@massanosnc.it

Imported by



Tools For Agriculture

220 S. Jefferson St- Dixon CA 95620 USA

“With Conformity Declaration (EEC) ”

📖 Read carefully the book before using the machine 📖

DECLARATION OF CONFORMITY

MASSANO s.n.c.

Frazione Cavallona – SAVIGLIANO (CN) - Italy

Tel (+39) 0172 – 377167 Fax (+39) 0172 – 377014

www.massanosnc.com E-mail: info@massanosnc.it

Holder of the technical dossier at head office Company: *Diego Massano*

certifies under its responsibility that the machine:

REVERSE TILLER RSE-PLUS.2

Type

Serial n.

Year

Complies with the following EU Directive:

2006/42/CE (New Directive machines)

To check the conformity of the machine refer to the following European Standards :

UNI EN ISO 4254-5:2010

UNI EN ISO 4254-1:2013

And the technical standard :

ISO 11684 *1995*

Savigliano (CN), _____

The legal representative

INDEX

INTRODUCTION	5
1 REMARKS	6
2 GENERAL INFORMATION	6
2.1 INFORMATION ABOUT THE BOOK-----	6
2.2 INFORMATION ABOUT THE MACHINE-----	7
2.2.1 Machine identification-----	7
2.2.2 Prescribed uses of the machine-----	8
2.2.3 Warnings-----	8
2.3 TECHNICAL FEATURES-----	9
3 MACHINE COMPONENTS AND TECHNICAL DATA -----	9
3.1 TECHNICAL DATA-----	11
3.2 ACCESSORIES -----	11
4 NOISE LEVEL -----	11
5 PACKAGING AND DELIVERY -----	12
6 STORAGE -----	13
6.1 RESTORATION AFTER A LONG STORAGE-----	13
6.2 DISPOSAL AND SCRAPPING-----	14
7 SAFETY RULES -----	14
7.1 GENERAL SAFETY AND ANTI-INDUTRIAL INJURIES RULES-----	15
7.2 SYMBOLS' GRAPHIC REPRESENTATION-----	17
7.3 LOCATION OF PICTOGRAMS ON THE MACHINE-----	20
8 INSTALLATION AND ADJUSTMENTS -----	21
8.1 SAFETY RULES FOR THE CONNECTION TO THE TRACTOR-----	21
8.2 CHECK OF TRACTOR'S LIFTING CAPABILITY AND STABILITY-----	21
8.3 CONNECTION TO THE TRACTOR WITH THREE POINT LINKAGE QUICK HITCH (AMERICAN HITCH)-----	22
8.3.1 BEFORE USE-----	22
8.3.2 HITCHING TO THE TRACTOR-----	22
8.4 CARDAN SHAFT ADAPTION-----	25
8.4.1 Adjustment of cardan shaft with discs clutch-----	27
8.4.2 Driveline with cam type torque limiter (Automatic) -----	28
9 TRANSPORT BY ROAD -----	29
10 IN WORK -----	31
11 USE OF THE MACHINE -----	40
12 CONICAL ROLLER BED SHAPER -----	42
12.1 REAR HYDRAULIC ROLLER-----	43
13 MAINTENANCE -----	44
13.1 ORDINARY MAINTENANCE-----	44
13.1.1 Greasing's time -----	45
13.2 Every 50 hours work-----	48
13.3 Recomended Lubricant-----	48
13.4 Every 250 hours work -----	48
14 ROTOR WITH BLADES -----	49
14.1 REPLACEMENT OF BLADES-----	49
15 ANALYSIS OF THE PROBLEMS, TROUBLE'S SEARCH -----	52
16 GUARANTEE -----	54
16.1 DURATION OF GUARANTEE-----	54
17 SPARE PARTS -----	54

INTRODUCTION

Dear customer,

We thank you for choosing our REVERSE TILLER RSE-PLUS.2. This book provides you all the information necessary for the use and maintenance of your machine. The correct functioning and duration of the machine depend on the correct maintenance and attention in its use.

Massano Snc and your dealer are available for any information regarding the running of the machine and also provide original spare parts to ensure its perfect fit in case of replacement.

In order to ensure the maximum reliability, this machine has undergone strict tests.

The technical information contained in this document are property of MASSANO Snc and must be considered confidential. Distribution and reproduction of this book, even if partially, are forbidden.

The technical data contained in this book are those provided by the manufacturer at the time of writing.

Any total or partial reproduction of this document or its content is forbidden by law.

You should therefore carefully read and understand each part of this USE AND MAINTENANCE BOOK.

The use of the machine for activities not foreseen in the project and not mentioned in this book releases MASSANO Snc from any direct or indirect responsibility.

Any unauthorized modification to the machine releases MASSANO Snc from any liability for damage or serious injuries, which may turn out the operators, third parties and things.



WARNING!

MASSANO Snc declines all type of objective and subjective responsibility when the rules mentioned in this book are not applied and respected.

1. REMARKS

This book together with the Declaration of Conformity has to be considered as an integral part of the machine provided by Massano Snc and it must be associated with the machine until its destruction.

If you don't receive the book or you lose it, we strongly suggest you to ask Massano Snc for a copy. Our offices will send it as soon as possible.

This book includes operation rules, standard and special maintenance, rules for the research of problems for the machine produced by Massano Snc.

We strongly suggest you to **read this use and maintenance book carefully**, and to follow scrupulously all the described instructions before using the machine.

If you run into problems with the comprehension of text/tables, or if illustrations/schemes are not clear, please contact immediately Massano Snc to get further information from skilled technicians or from the book editor.

Massano Snc is at disposal of users, sales managers and other interested people in order to establish an active collaboration to improve the understanding of this book.

In compliance with current laws, information concerning dangerous situations are pointed out in chapter 7.

This book has been filled in according to laws in force at the time of printing.

This book has to be considered as an integral part of the machine and, together with the Conformity Declaration, it must be associated with the machine until its destruction.

2. GENERAL INFORMATION

2.1 INFORMATION ABOUT THE BOOK

This book provides all the information for the use and maintenance of Reverse Tiller produced by MASSANO Snc. The correct operation of the machine and its duration depend on its correct maintenance and use.

Please note that some details in the pictures may differ from the machine in your possession, some component could have been removed in order to ensure pictures' clarity.

This book deals with all the topics required by EEC "Directive 2006/42/CE" and pertinent technical rules.

According to EEC rules, the operator must keep the special pictograms on the machine in good conditions and replace them if illegible.

The instructions in this book are addressed to a skilled user with specific knowledge of tractor's driving. The authorized user must be correctly trained.

The technical information contained in this book are property of Massano Snc and they are strictly confidential.



WARNING!

We strongly suggest you to use only original spare parts and accessories.

The use of non-original parts could invalidate the guarantee, be dangerous and reduce the performance of the machine.

2.2 INFORMATION ABOUT THE MACHINE

Massano Snc has selected the building materials in compliance with the specific use the machine has been designed and built for. All uses different from those highlighted in this book can cause damage to properties or injuries to people and can compromise the correct functioning of the machine.

According to the prescribed use of the machine, this book draws operator's attention to the importance of observing use, repair and maintenance rules.

All uses different from those highlighted in this book release Massano Snc from all direct or indirect liability.

Any change to the machine releases Massano Snc from all liability for damages to properties or serious injuries to operators or to third parties.

The correct use of the machine in conformity with the instructions illustrated in this book and the methodical application of safety rules in order to prevent any hazardous situation will ensure the reliable duty and long life of the machine.

2.2.1 Machine identification

On the frame of the machine you can find the EEC brand and the identification label giving manufacturer's data, model, serial n., production year and weight of the machine.

EEC plate

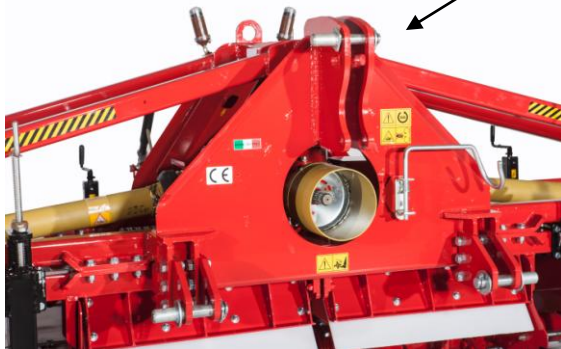

 MASSANO snc <i>Farm, Horticulture and Garden Equipment</i>			
Modello Model	<input type="text"/>	Peso Kg. Weight	<input type="text"/>
Matricola N° Serial N°	<input type="text"/>	Anno Year	<input type="text"/>
SAVIGLIANO (CN) Italy - Via Costigliole 4 - Tel. +39.0172.377167 - Fax +39.0172.377014 info@massanosnc.com www.massanosnc.com			

Location of the EEC plate on the machine

The information shown on the identification plate are necessary to request spare parts..

It is absolutely forbidden to remove and/ or modify all or part of the data specified on the identification plate of the machine.

The machine can be used only for agriculture, as previously described.

**WARNING!**

**The machine must be used by a single operator.
Different uses will be considered incorrect.**

If some pictograms will be damaged or get lost, they should be requested specifying the identification data on the recognition plate.

This machine is generally used during the day. If you want to use the machine by night or in conditions of reduce visibility, as an exception, you must use the lighting system of the tractor.

2.2.2 Prescribed uses of the machine

The **Reverse Tiller** machine, mod. RSE-PLUS.2 has been designed and built in order to be used in the agricultural sector for cultivating together with burying stones, clods and vegetable residues.

This machine is mounted on the tractor by means of a **three-point hitch**.

This machine has been realised to remove stones, clods and vegetable residues from the surface in a single pass.

The main component is the blade rotor, that rotates counter clockwise throwing stones, soil, grass and debris against a selection grill. The raw material falls inside the furrow made by the rotor and then it is covered by fine soil forming a perfect seed bed. In this way the machine creates satisfying results with just one pass without creating a work pan and guaranteeing excellent drainage of the worked ground.

The selection grill works as a sieve. The user can work in any soil condition, even on wet ground, thanks to the selection grill's vibrating system avoiding soil's sticking. The adjustable height of the selection grill enable the machine to work in depth without taking too much power from tractor.

The working depth is adjustable from 10 to 28 cm (from 4 to 12 inches) acting on the pontoon. In soils with stones bigger than 22-25 cm (8-10 inches), it is necessary to remove them, by hand or by machine, before starting work.

Use the machine in the agricultural sector only.

2.2.3 Warnings

List of the main contraindications when using the machine :

- Remove all foreign matters (e.g. metal pieces or glass bottles) from the working area.
- Follow and apply meticulously the instructions regarding the height's adjustment and keep a safety distance from the machine (50 meters) during machine's work.
- Before starting work, remove grass and brushwood to avoid damaging the machine.

2.3 TECHNICAL FEATURES

The REVERSE TILLER TYPE FRANGITER RSE PLUS.2, with different power features, has been designed to work in the heaviest conditions minimizing the possibility of damage and wear. This feature is guaranteed by the use of high quality materials during all stages of machine's construction and can reduce amortization costs to a minimum.

During production and construction stages we kept to all the necessary precautions in order to supply a high quality and reliable product in full compliance with in force laws , in particular with the prevention of injuries.

3. MACHINE COMPONENTS AND TECHNICAL DATA

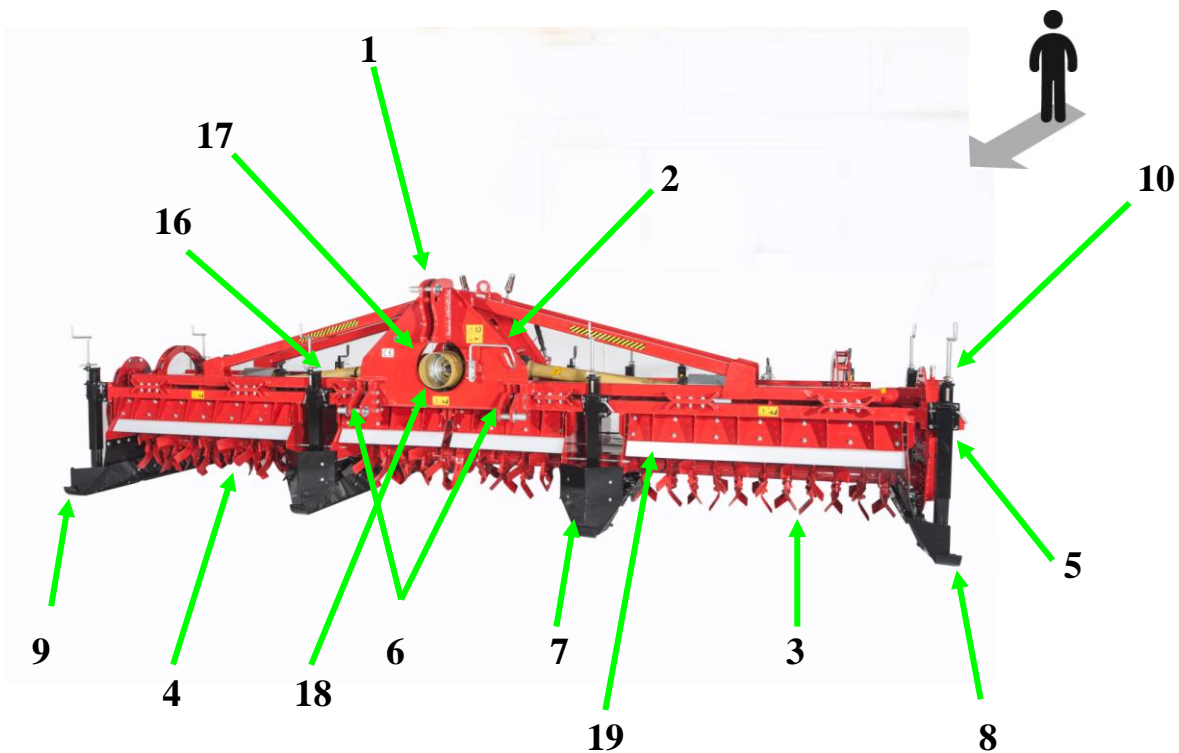

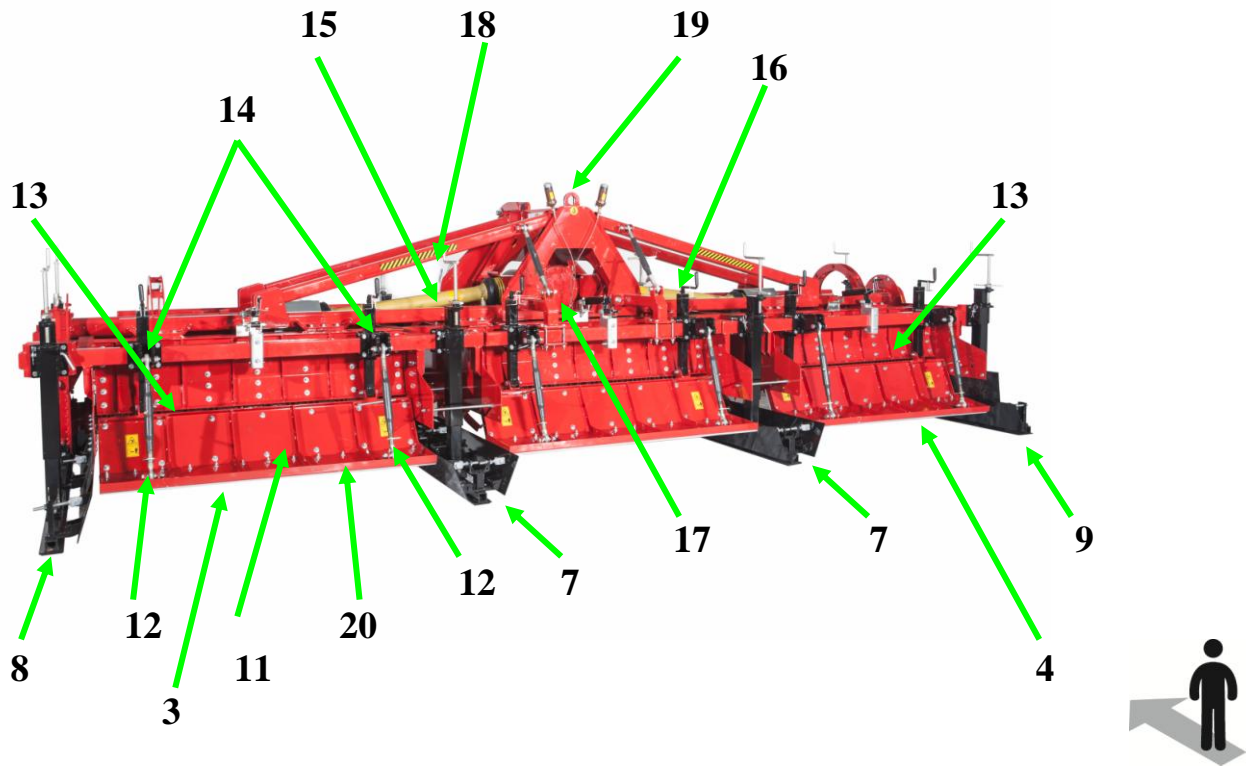

Machine components

- 1 – Upper “3rd point” hitch
- 2 – Cardan shaft support
- 3 – Frangiter rotor left
- 4 – Frangiter rotor right
- 5 – Side transmission unit
- 6 – Lower “3rd point” hitch
- 7 – Front pontoon
- 8 – Side pontoon left
- 9 – Side pontoon right
- 10 – Adjustment jack for pontoon

- 11 – Bed former shaper
- 12 – Bed former adjustment jack
- 13 – Safety plate
- 14 – Safety plate adjustment jack
- 15 – Cardan shaft left
- 16 – Cardan shaft right
- 17 – Gearbox
- 18 – Safety guards
- 19 – Complete plastic frame
- 20 – Complete plastic bed former

3.1 TECHNICAL DATA

Mod. REVERSE TILLER from 180 to 360 HP

Mod. REVERSE TILLER	Width of work (inch)	Max width (inch)	Ø Rotor (inch)	Blades N°6 each Flange	Speed rotation rotor with P.t.o. 1000 rpm	Required power min.-max (HP)	Weight including Bed former shaper and pontoon (Kg/Lbs)	Working depth Min/max. (inch)	“S2” Quote (inch)
3x80	3x80	250	22/23	192	300	180-360	4330/9550	4/12	35/38
3x84	3x84	260	22/23	192	300	200-360	4450/9810	4/12	35/38

3.2 ACCESSORIES

- **Maintenance stands:** allow to carry out maintenance intervention or adjustment of the machine in conditions of greater security. They have special hooks on which you can set down with care the machine that will be completely stable. You have to put the machine in a lightly angled position in order to make the operations easier.
- **Rear wheels:** allow to regulate the working depth when shaping the bed.
- **Motorized hydraulic roller:** allows to compact the bed on the sides and to use a sowing machine above the bed without breaking the edges.
- **Durafaces blades:** allow the use of the machine in particularly clayey soil, greatly reducing component’s wear that are usually compromised when used on particular type of grounds.
- **Plastic covering type UHMW :** used on moist/wet soils.
- **Oil cooler for gearbox:** used to cool the oil inside the gearbox.

4. NOISE LEVEL

All MASSANO Snc machines underwent a severe noise level test.

The sound emission level is 82 dB(A) ± 1 Db, measured in open field at 120 inches from the machine and at 63 inches from the ground, when the machine continuously worked at maximum speed allowed.

Although there is a correlation between the sound emission and exposure levels, this data cannot be used to determine if it is necessary to take precautions when using the machine. There are in fact other elements that may affect the sound exposure level, such as the working environment features and the presence of other noise sources. However, the information about the uttered noise level of the machine will help the user or the employer in the drawing up of the evaluation of dangers and risks.



Anyway we suggest you to use devices for hearing protection.

ATTENTION!

5. PACKAGING AND DELIVERY

It is not necessary to pack the machine. It is usually supplied by MASSANO Snc ready to be used previously adjusted for work and it is shipped in this condition.

ATTENTION!



In order to lift the machine use safety hooks and ropes or chains of adequate capacity. They have to be put in the suitable lifting points. They are appropriately pointed out on the pictograms on the machine. You can see them at the next pages.

Before lifting the machine it is necessary to check, using "Technical Data" schedule contained in this User and Maintenance Book, the mass of the machine, properly sizing the used lifting equipment.

For the transport by road of the machine that is not connected to a tractor by the rear lifting system, after lifting the machine by crane or bridge crane, it must be put down with care on the flatcar of a suitable means of transport, with sufficient capacity and it has to be fastened to the flatcar .

In order to carry out lifting operations, loading and transport of the machine it is strongly suggested to employ skilled trained staff (embarkers, forklift truck workers, etc.).



ATTENTION!



Before lifting the machine, make sure that the device used (crane, bridge crane, forklift truck, etc ..) is sufficiently sized in relation to the mass of the machine you have to move (Mass of the unit, see section 3.1 "Technical data")

Do not move the machine without checking its perfect stability during the operations you have to carry out.

6. STORAGE

If you do not use the machine for long periods, you need to store it in a dry environment, sheltered from the weather, and protect it with a perspired piece of material (eg. fabric) to avoid dust accumulation and moisture formation that can damage the non- painted parts (front discs, tools, rear frame, rear ploughshares, etc.).

Before storing the machine, it is suggested to clean it with care using a pressurized water jet and/or compressed air (pay attention when you are cleaning the sections near the drive shaft and the clutch. Water's pressure can compromise the correct functioning of drive shaft and clutch), dry and grease all the sections described in this book. Grease adequately all non- painted mechanical parts in order to protect them from the rust.

Check: the wear of all tools, the tightening of the fixing screws, the presence of paint on the whole machine, the presence of all pictograms restoring them if missing, the presence of all protection and safety devices of the machine (eg. P.t.o. casing, front spacer bars, support for the hydraulic pipes, support for the drive shaft, etc.), the oil level within the gearbox, the oil level in the side transmission.

- Position the machine in a safe and secluded place without slopes, in order to not hamper the transit of people and vehicles, make sure that this place cannot be reached by unauthorized people, especially children.
- Position the machine on the ground, switch off the tractor, disconnect the ignition key from the switchboard and start up the hand brake.
- Disconnect the machine from the tractor, as described in this book.
- Once the disconnection of the machine is ok, you have to put again the three-point pins into the suitable holes in order to avoid their loss.

6.1 RESTORATION AFTER A LONG STORAGE

Before you start using the machine after a long storage it is necessary to follow the instructions below:

- Check the machine to identify if there are some rusted metal parts, missing pictograms, structural deformations or oil leaks. In case you notice the presence of one or more of these situations, act in the most appropriate way. If necessary, contact MASSANO Snc or its dealer;
- Wash the machine with care, grease the points highlighted in this book and on machine's pictograms;
- Check that the hydraulic pipes are intact. In case you notice abrasions, cuts or cracks of pipes replace them immediately. Remember that every six (6) years from the manufacturing date of each pipe, it must be replaced.
- Check the presence of all the machine's parts, in particular the protection devices (eg. P.t.o. casing, front spacer bars, etc.) and the additional components (eg. drive shaft, connecting pins, of pipes and drive shaft's support, etc ..).
- Check the oil level inside the gearbox
- Check the oil level inside the side transmission
- Check the correct running of all the adjustment cranks of the machine greasing them if necessary.
- Connect the machine to the tractor as described in section 8.3. **Application of any implement to a tractor is a very dangerous operation and must only be carried out with utmost care in compliance with the instructions.**

6.2 DISPOSAL AND SCRAPPING

In case of scrapping the machine must be disposed of in suitable dumps, in accordance with current legislation.

Recover the exhausted oils and dispose them of in the suitable collection centers.

Before scrapping the machine it is necessary to separate plastic or rubber parts from the iron ones.

Plastic, rubber, aluminum and steel parts can be recycled, if collected separately from the suitable centers.

Exhausted oil must be appropriately recovered and should not be scattered into the environment, because, according to current legal regulations, it is classified as hazardous waste; for this reason you have to give it to a collection site. Then contact the closest Consortium of Exhausted Oils.

THE FOLLOWING RULES SAFEGUARD YOUR SAFETY. YOU MUST READ THEM CAREFULLY, MEMORIZE THEM AND APPLY THEM ALWAYS.

7. SAFETY RULES

Use the machine, perform periodic checks and maintenance intervention in compliance with the current safety rules.

The non-observance of rules or basic safety precautions could cause accidents during work, maintenance and repairing.

Each use of the machine that differs from that described in this book, and for which the machine has been designed, is forbidden and its execution must be clearly authorized in writing by our Company.

Every change you bring the machine that is not previously authorized by the manufacturer (in writing) releases MASSANO Snc from all civil and criminal liabilities towards people and/ or things.



WARNING!

MASSANO Snc is not responsible for possible damages caused by a not foreseen or inadequate use of the machine.

Do not tamper with or remove protections and safety devices applied on the machine for operator, people and machine safety.

The machine must be exclusively used by authorized trained staff with driver's license which knows how the machine works and the dangers.

In case of doubts, please contact directly our technicians.



WARNING!

All the instructions below help in the operator and third parties' safety during the use of the machine. They have to be respected in order to avoid unpleasant accidents.

7.1 SAFETY AND ANT-INDUSTRIAL INJURIES RULES



WARNING!

Check the machine before starting work.

The user can only do operations described in this Use and Maintenance Book. All the operations not described in this book have to be considered **FORBIDDEN** and their execution is only allowed to **MASSANO Snc** authorized staff (manufacturer's technicians or dealer's mechanics)

Massano Snc cannot foresee all possible circumstances that are able to cause dangers. Warnings contained in this book and on the machine are not complete.

- In addition to the warnings included in this book, please observe all general safety and anti-industrial injuries rules.
- Use the machine carefully with common sense and responsibility.
- Do not use the machine or service it before reading and understanding the instructions contained in this book.
- The symbols on the machine give you important information and their observation keeps you safe.
- Make sure that all safety pictograms are readable. Clean and replace them, if necessary.



WARNING!

Before using the machine the user have to know how the machine works.

- Before using the machine, make sure that all safety devices are correctly placed and in good conditions. If they are broken or damaged replace them exclusively with original Massano spare parts.



WARNING!

Before using the machine, make sure that there are no people or animals within 50 mt. Before getting off the tractor and before serving the machine, put it on the ground. The operator must pull the hand brake, switch off the tractor and remove the ignition key.



- This instructions' book must be always within reach of the user in order to check the working process of the machine during its use. If you lose this book or if it is damaged please ask MASSANO Snc for a copy.
- **The machine must be used exclusively by authorized trained staff with driver's license for tractor. The machine is connected to a tractor.**
- **The machine is designed to be used by a single operator, who during all the operations must remain on the tractor.**
- Do not use the machine if you are tired, ill or under the influence of alcohol, drugs or medicines.
- **We suggests you not to wear clothes that could get caught (sleeves without closed cluff, belts, necklaces, bracelets, rings).**
- Make sure that the machine has not been damaged during the transport. If it has been damaged inform MASSANO Snc immediately.



During work, maintenance, repairing, transport and storage of the machine, the operator must always wear a close- fitting overalls, safety shoes, safety gloves and, if it is necessary, anti- dust mask and casing for hearing protection.

- While working, the machine can raise dust, especially if the ground is dry. We suggest you to use tractors with cabin, equipped with filters in the ventilation system or to use suitable protections for respiratory tract e.g. anti- dust masks or masks with filter .
- Keep the machine free from foreign materials (e.g. waste, tools, different type of objects) that may cause damages or injuries.



DANGER!

It is forbidden to get on the machine or to make oneself carried when it is moving.

Check before, during and after the use of the machine that the drive shaft protections are intact and in good conditions.

- When connecting the machine to the tractor, make sure that the drive shaft is correctly engaged (see section 8.3)
- Disconnect the machine from the tractor only on a flat and firm ground, make sure that the machine is steady and stable.
- In case of breaking or deterioration of protections, replace them immediately with original MASSANO spare parts.

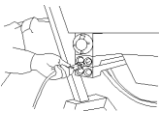

Check that hydraulic pipes are correctly connected, according to the recognition colour code. Remember that their reversal causes movements opposite than the usual ones .

- When the machine is disconnected from P.t.o., put the hydraulic pipes and the drive shaft on the suitable provided supports.

WARNING!



When the engine and/or P.t.o. is running, do not interpose between the tractor and the machine.

In order to perform all the operations you have to switch off the tractor, pull the hand brake, remove the ignition key and, if possible, lower the machine on the ground.

- Every machine's change may cause safety problems. In this case the user is responsible for possible accidents.



Massano Snc is not responsible for:









- Incorrect use of the machine or employment by non-trained staff ;
- Heavy lacks in the expected maintenance;
- Non- authorized changes or interventions by Massano Snc;
- Use of non-original spare parts or not specific spare parts for this type of machine;
- Total or partial non-observance of instructions contained in this book;
- Non- observance of common safety rules;
- Exceptional events.





7.2 SYMBOLS' GRAPHIC REPRESENTATION.

The symbols below draw operator's attention to hazardous situations that may happen, and give you safety indications.

Following symbols are indications of danger or duty and the operator must observe them.

SYMBOL	DESCRIPTION
	<p>1. ATTENTION Before using the machine, read and understand the use and maintenance book supplied with the machine.</p>
	<p>2. ATTENTION Before any maintenance or adjustment, stop the machine, switch off the tractor, pull the handbrake, remove the ignition key and read the use and maintenance book.</p>
	<p>3. ATTENTION – Danger of under pressure fluids. Read the book carefully before acting. In case of contact with harmful fluids, see a doctor immediately.</p>

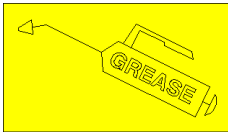
	<p>4. ATTENTION – Before connecting the drive shaft, check P.t.o.’s direction of rotation and number of revolutions (1000 rev/1’).</p>
	<p>5. ATTENTION – Danger of contact with blades. Do not bring feet near the machine.</p>
	<p>6. ATTENTION – Because of possible dropping of flying objects/materials, do not stop near the machine and do not come up to it. Keep a minimum safety distance of 50 mt.</p>
	<p>7. ATTENTION – Do not get on the machine.</p>
	<p>8. ATTENTION – Danger of getting caught and dragging by the machine. Do not bring hands near the drive shaft when it is working.</p>
	<p>9. ATTENTION – Do not stop between the tractor and the machine.</p>
	<p>10. ATTENTION – Do not remove or open protection’s casing until the gears are completely steady.</p>
	<p>11. ATTENTION – Before bringing near the machine, wait for a complete stop of the rotating parts.</p>

	<p>12. ATTENTION – DANGER of crushing and shearing. Do not place the hands near to the shear points.</p>
	<p>13. ATTENTION – To lift the machine, hook it in the indicated points</p>
	<p>14. Use the required protection devices.</p>
	<p>15. Greasing points.</p>
	<p>16. CEE stamp.</p>
	<p>17. Aluminium plate with technical data and serial number.</p>

7.3 LOCATION OF PICTOGRAMS ON THE MACHINE



WARNING!

Make sure that the safety pictograms on the machine are readable. Clean them using a cloth, soap and water.

Replace damaged labels and stick on the new ones in the correct place, as shown below.

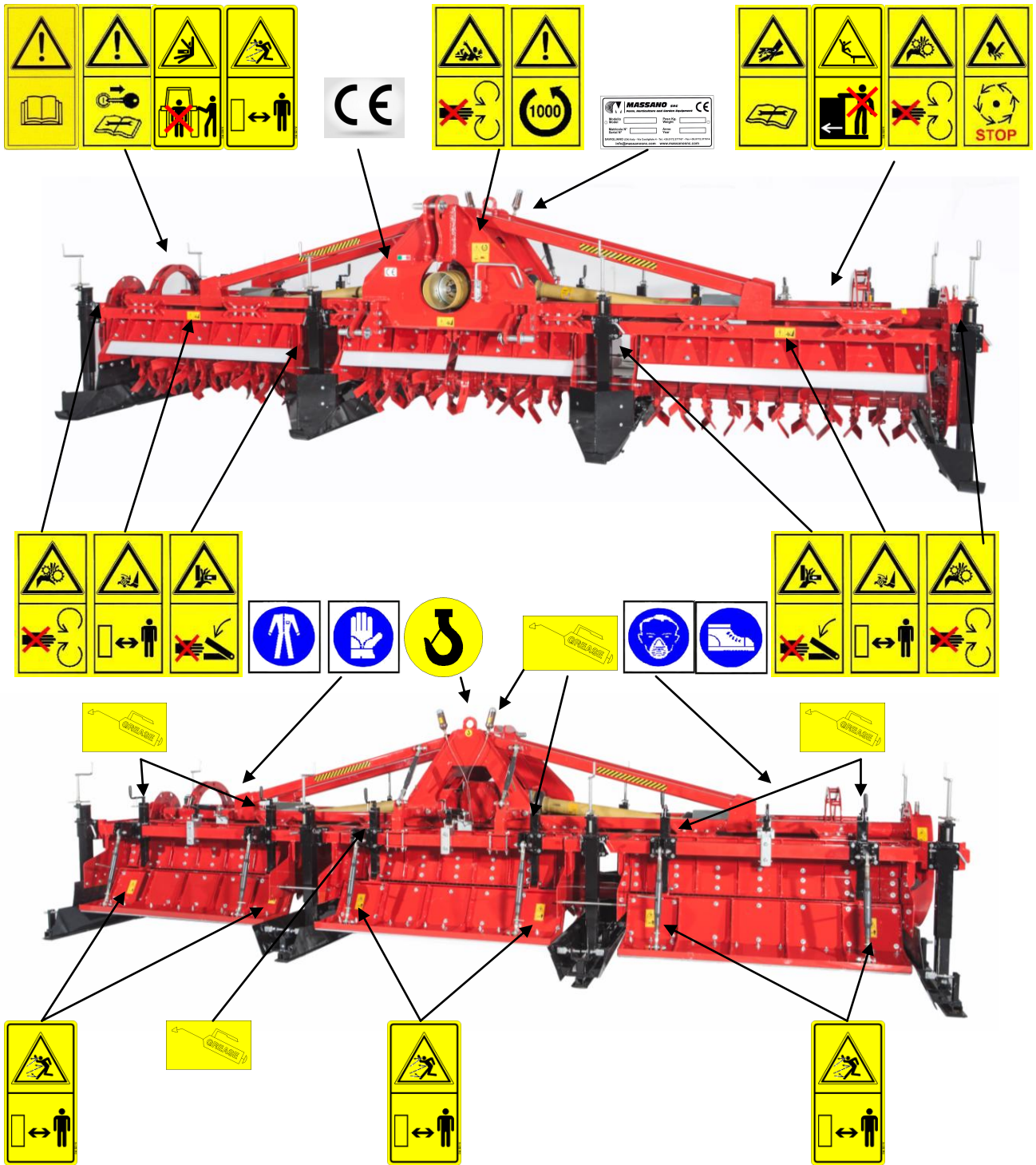

8. INSTALLATION AND ADJUSTMENTS

8.1 SAFETY RULES FOR THE CONNECTION TO THE TRACTOR

	<p>WARNING!</p> <p>During work, maintenance, repairing, transport and storage of the machine, the user must always wear safety shoes, safety gloves, casing for hearing protection and anti- dust mask in order to protect himself from objects' dropping due to machine running.</p>
---	---

Assembled tools affect tractor's behaviour on the road, its stability, its steering and its braking capacity when they are carried.

In order to avoid overbalancing, loss of stability and control of the tractor, go on always at a reasonable speed, particularly if there are uneven grounds or steep slopes.

Before connecting the machine to the three point hitch, position the tractor's safety device so that the lifting device cannot rise and lower itself involuntarily and/ or accidentally.

In the area of the rear lift arms of the tractor there is a risk of injury due to crushing and cutting points: connect and disconnect the machine only on firm and flat surfaces. In order to do all the operations outside the tractor's cabin, you have to switch off the engine, pull the handbrake, remove the ignition key from the panel and keep in your pocket.

Use the external lift control following the information contained in the tractor's Use and Maintenance Book operating with extreme caution.

When transporting the machine, make sure that the linkage's lateral catch of the tractor's lower lifting arms is completely locked.

8.2 CHECK OF TRACTOR'S LIFTING CAPABILITY AND STABILITY

Before connecting the machine to the tractor, check the lifting capability and stability of the tractor, using the following formula and if it is necessary (and if it is possible) previously apply the ballasts. In order to determine the total weight of the machine it is necessary to add the weight of all its components (see section 3.1).

$$I_{F,min} = \frac{(I_R \times (c+d)) - (T_F \times b) + (0,2 \times T_E \times b)}{a+b}$$

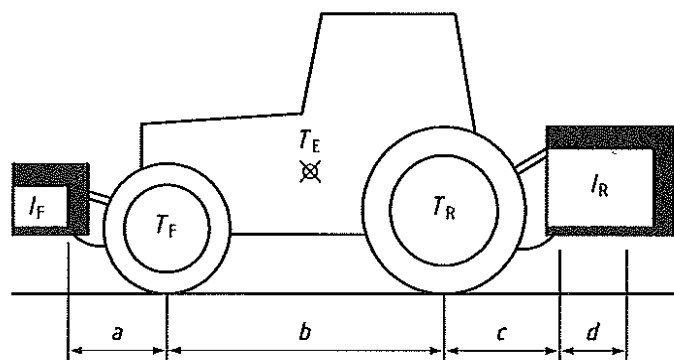

Legend:

- T_E** (kg) – Tractor’s mass.
- T_F** (kg) – Front axle load of unladen tractor.
- T_R** (kg) – Rear axle load of unladen tractor.
- I_R** (kg) – Combined mass of rear equipment capacity/ rear ballast.
- I_F** (kg) – Combined mass of front equipment capacity/ front ballast.
- a** (m) – Distance from the barycentre of front equipment capacity / front ballast to front axle centre.
- b** (m) – Tractor wheelbase.
- c** (m) – Distance from the rear axle centre to the lower link ball.
- d** (m) – Distance from the lower link ball centre to the barycentre of the rear equipment capacity/ rear ballast.

8.3 CONNECTION TO THE TRACTOR WITH THREE POINT LINKAGE QUICK HITCH (AMERICAN HITCH).

The REVERSE TILLER can be mounted on tractors equipped with THREE POINT LINKAGE QUICK HITCH (American hitch).

8.3.1 BEFORE USE

Before starting work with the machine, check that the machine is perfectly in order, that the lubricants are at the correct levels (see section 13) and that all parts subject to wear and deterioration are fully efficient.

8.3.2 HITCHING TO THE TRACTOR

The Reverse Tiller is coupled to the tractor with the machine on the ground. The ground area should be flat.

All the machines can be attached to any tractor with a three point linkage quick hitch.

 <p>DANGER!</p>	<p>Application of any implement to a tractor is a very dangerous operation and must only be carried out with the utmost care in compliance with the instructions.</p>
---	--

The correct tractor/ machine position is established by setting the implement at such a distance from the tractor that the universal coupling remains 2-4 inches from its maximum closing position.

Now follow the instructions below:

- Check that the width of the tractor's three point linkage quick hitch is compatible with the Reverse Tiller you have to connect.
- Lift hooks number 1 and approach to the Reverse Tiller inserting connections number 2 and 3 inside the couplings number 4 and 5
- Check that the coupling's points 2 and 3 are correctly hooked to point 4 and 5 as shown in picture number A.



PICTURE (A)

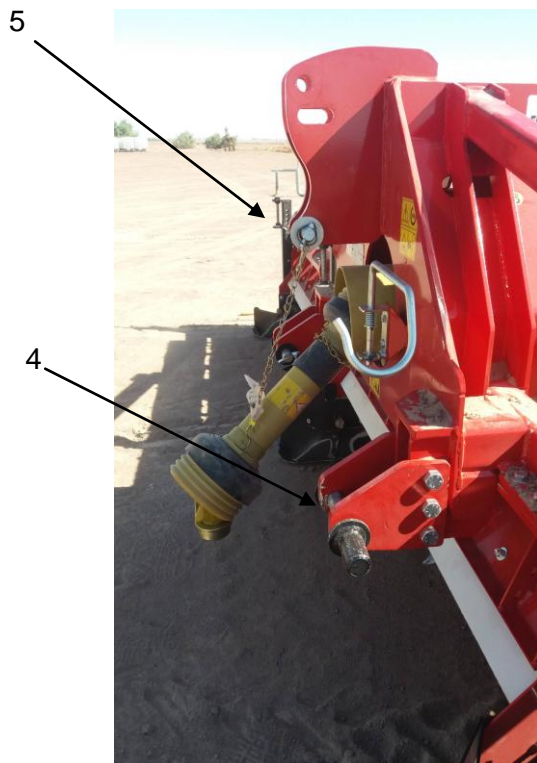

Lock the lever number 1 and check that the safety hooks number 6 have locked pins number 7-8. This procedure is very important for the safety during the transport by road.

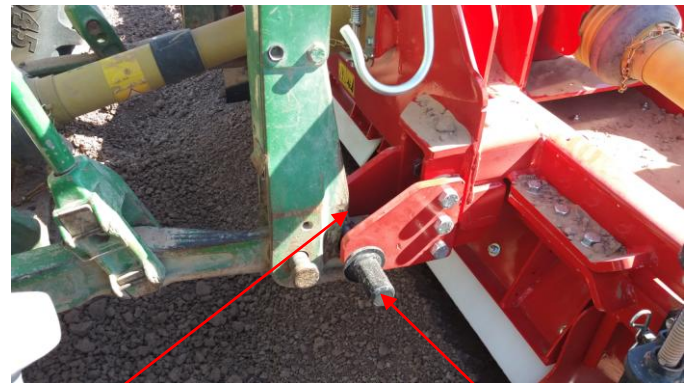

6

7

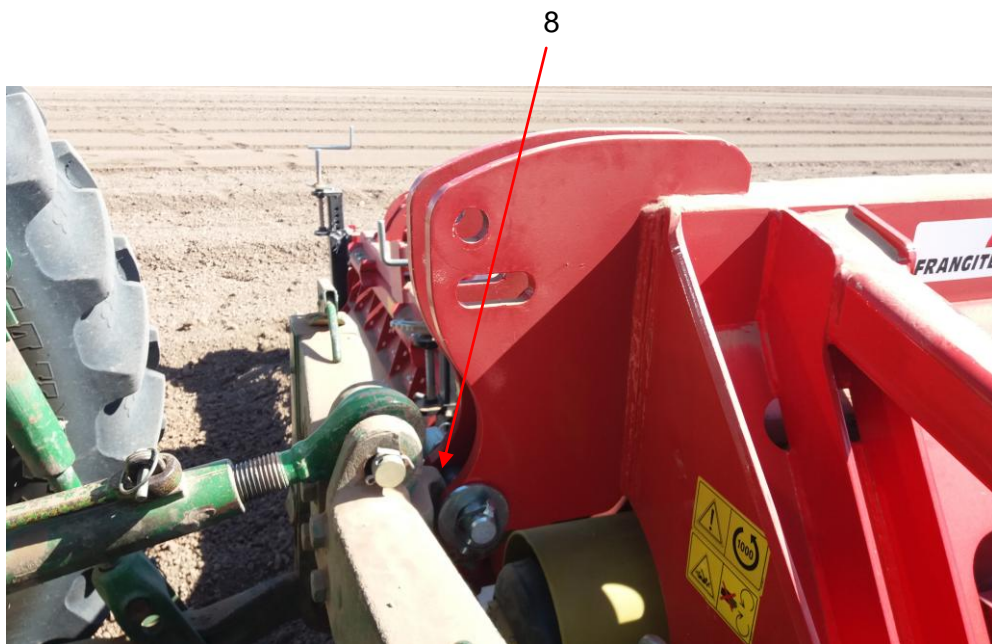

8.4 CARDAN SHAFT ADAPTION.

Before using cardan shaft, read its Use and Maintenance Book and check that guards are intact. Check that the cardan shaft and machine P.t.o.'s guards are superimposed at least 50 mm according to safety rules.

The cardan shaft, supplied with the machine, is of standard length. Therefore it might be necessary to adapt it.

In that case, before doing anything, consult the Manufacturer for the eventual adaptation.

Hitch the machine to the tractor and stabilize the tractor's third point with the device installed for that purpose (bar, chain, etc..)

Bring near the two take-offs so that they are aligned and as closely as possible, turn off the engine and put the parking brake.

PICTURE (B)

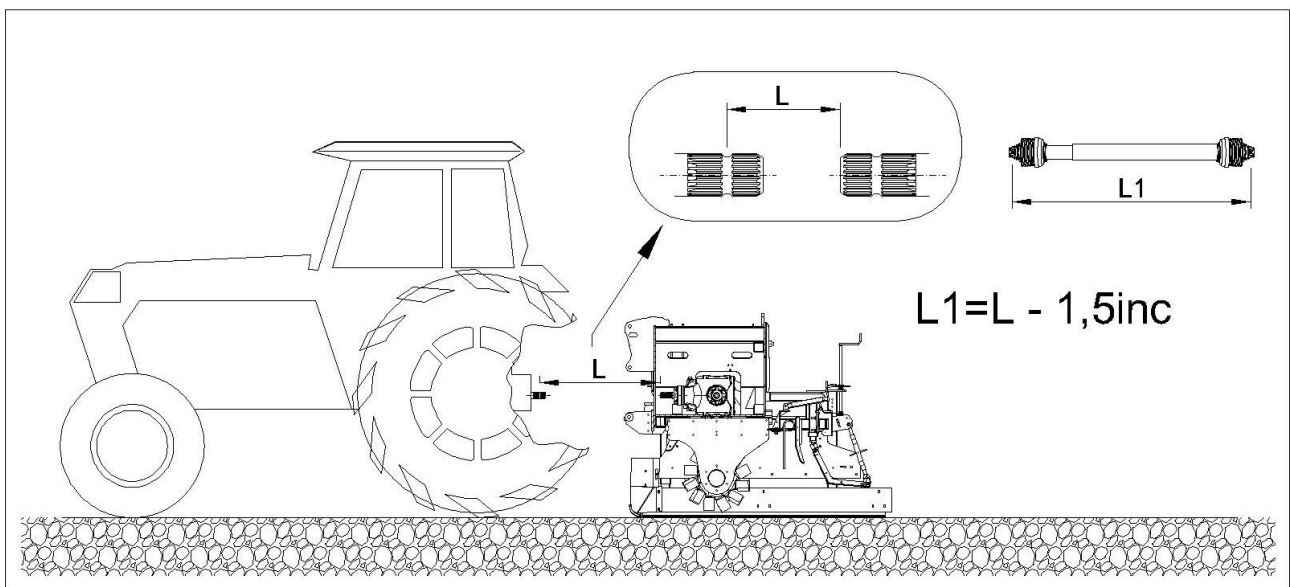

Measure the distance L , (Picture B). Then measure the length $L1$ of the cardan shaft (Picture B). The length $L1$ of the cardan shaft must be equal to the length $L - 1\frac{1}{2} / 1\frac{3}{4}$ (to allow a minimum clearance to the cardan shaft). The remaining length will be the length of the cardan shaft to be cut on both tubes of the shaft. (Picture B).

PICTURE C

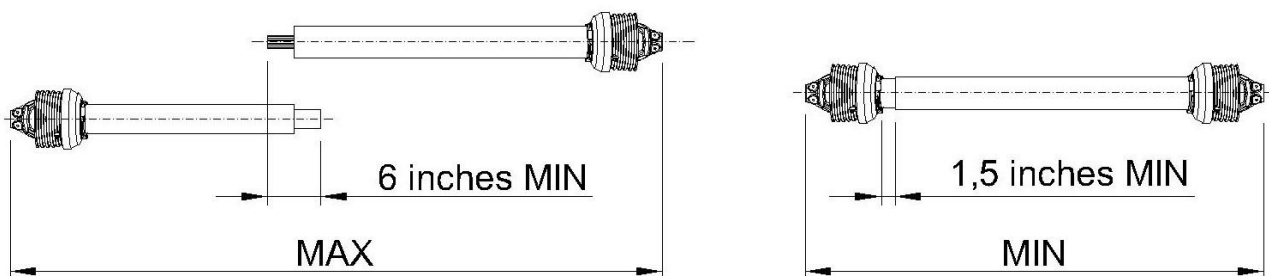

Then , do the following:

- Shorten the outer sliding tubes by the same extent, then do the same operation with the internal ones, deburr, trim and grease the inside of the outer tube (Picture D).

PICTURE D

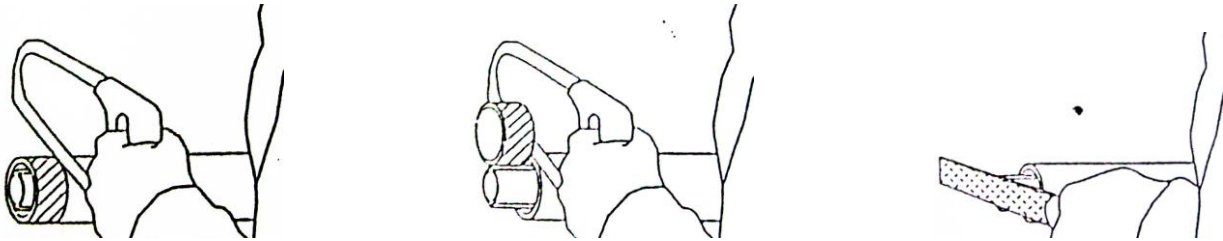

ATTENTION!

When the cardan shaft is fully extended, the two tubes must overlap by at least 6 inches. When fully inserted, the minimum play must be 1 ½ inches.



ATTENTION!

If the implement is used on another tractor, always check its the dimension L in order to avoid cardan shaft's damaging.

- o Switch off the engine, pull the handbrake and remove the ignition key.
- o If necessary, grease the cardan shaft following Manufacturer's instructions step by step (see cardan shaft's book). Use only manual greasing pump.



ATTENTION!

When greasing the cardan shaft make sure that the grease used is a lithium one and that it can achieve a melting temperature of 250° C. Use always a manual greasing pump to grease the crosses.

DO NOT USE COMPRESSED AIR PUMPS.

- o When connecting the cardan shaft, follow assemblage instructions given by Manufacturer and stamped on guard outer coating.
- o Make sure that safety anti-slip off block (button) is inserted and fixed correctly.
- o Hook anti-rotation chains.

In case that cardan shaft is not equipped with safety button catch, but with bolt, make sure that it is well tightened. (SEE A)

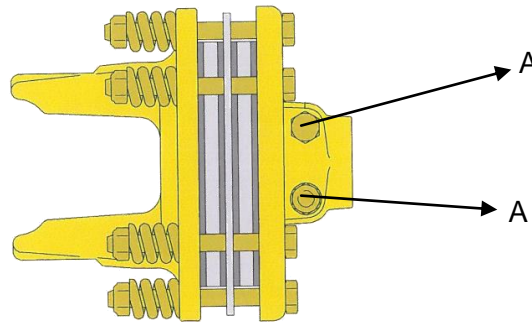

8.4.1 Regulation of cardan shaft with discs clutch

All standard machines are equipped with cardan shaft with discs clutch against overloads. Springs B tighten by nut C keep the pressure on the friction discs steady. Tightening the nuts increases the pressure on the friction discs that intervene only in case of overload.

For a correct functioning of the clutch, the power exerted by the springs must not go beyond certain limits otherwise the cardan shaft become the direct P.t.o. without security.

During the use it could be necessary to tighten uniformly the bolts because the wear of lining reduces their pressure.

Following you can find a schedule with the maximum torque transmitted to the cardan shaft according to spring's height (D).

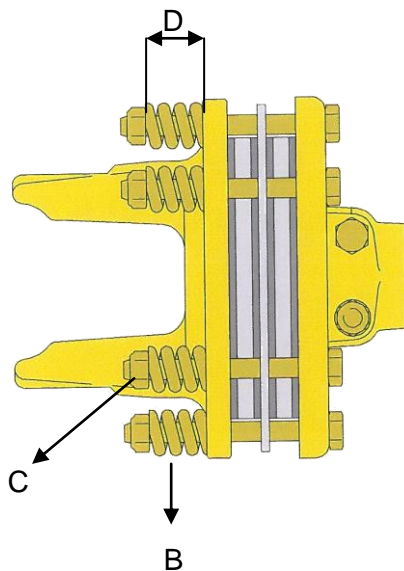

HEIGHT (D) (mm)	TORQUE (N/m)
27	2800
27,5	2400
28	2200
28,5	2000
29	1700
29,5	1400
30	1100





ATTENTION!

Do not tighten bolts to the end reducing the light D on the springs because in this case the clutch become the direct P.t.o. without security.

ATTENTION: if clutch still slips, replace the friction's discs.

If clutch doesn't slip, unscrew all nuts equally.

Unscrew one turn at a time the nuts (C) and check the clutch after ¼ mile of work. Repeat this operation, if necessary.

 WARNING	<p>For mod.: REVERSE TILLER RSE-PLUS.2</p> <p>Check that the P.T.O. speed rotation of the tractor is about 1000 rev/1', which is the rotation speed the machine has been designed for.</p>	
---	--	---

When the machine is not connected to the tractor, the cardan shaft has to be disconnected from P.T.O. and set on the provided support.



8.4.2 Driveline with cam type torque limiter (Automatic)

This device (Picture E) protects the transmission components of the machine from stress and excessive overloads. Drive transmission actually stops in the case of an overload. You must stop the P.t.o., left the machine, go back with the Reverse Tiller and start again.

	<p>WARNING! – WITH AUTOMATIC CLUTCH ALWAYS 1000 Rpm</p> <p>Avoid frequent and extended overloads. The driveline is calibrated by the Manufacturer. Do not tamper with the device if operational faults occur. Contact the driveline supplier or a specialized centre if necessary.</p>
---	---





ATTENTION!

Always stop P.T.O. when lifting the machine.

Cardan shaft must be last connected to P.T.O. and first disconnected after working.

The use of cardan shaft with “CE” certification guarantees the correct and safe functioning of the machine.

Use cardan shafts with intact safety guards only.

Cardan shaft length has to be adjusted according to the tractor used.

Always set cardan shaft on the specially provided support, when disconnected.

In case of improper installation and use of the cardan drive, Massano Snc declines all liability for damages.

9. TRANSPORT BY ROAD



ATTENTION!

For road transport it is necessary to:

- **Make sure that the tractor used for road transport is properly certified and have all the documents to circulate on road.**
- **Have a valid driving license for the tractor used on road.**
- **Check the cleanliness of the tires before going on public roads.**
- **Follow carefully the highway code in force.**
- **Do not carry the machine and do not drive the tractor under the influence of alcohol, medicines or drugs.**
- **Install appropriate size warning signs for road traffic (in case the machine is larger than the tractor to which it is connected).**

Always disengage the P.t.o. when the cardan shaft is set at an excessively open angle (never beyond 10°).

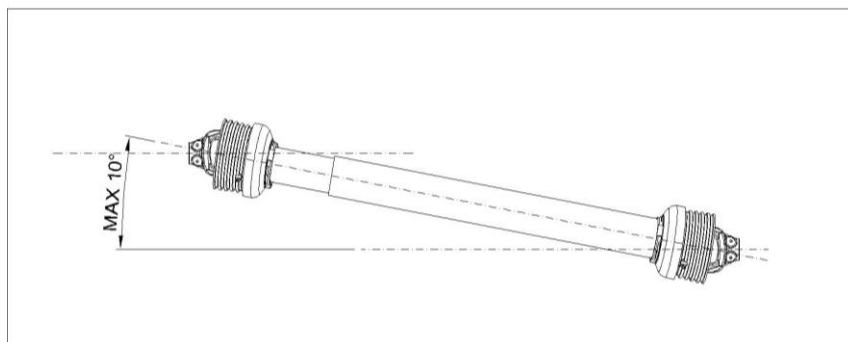

Check, however, that during transport, the machine cannot collide with the ground or dips on the road.

During transport, or whenever the machine must be raised, it is advisable to adjust the lift unit of the tractor so that the machine is not raised more than about 14 inches from the ground.

If the width of the machine cover the rear lights of the tractor you must install lights on the rear of the machine.

Check that the drive levers of the hydraulic lifting are locked to avoid the fall of the machine during transport.

Together with the observance of the rules it is important to remember that when driving on public roads close attention must be paid to the choice of an appropriate speed, especially with the vehicle-led with strong overhangs front and/ or rear or when the road looks crowded, twisty, bumpy or sloping.

Coming on the road after working, check the cleanliness of the tires and of the working parts, to avoid smearing with ground or other material the road surface.

Make sure that the lower links of the tractor's three point lifting are completely blocked by side tighteners, to avoid dangerous lateral swings of the machine during the transport.

Check every 200 hours work the entireness of connection pins. In case of wear ask your dealer for replacement.

10. IN WORK.

Start work with the P.t.o. at running rate (1000 rpm), gradually lowering the machine into the soil. Never excessively press down on the accelerator pedal when the P.t.o. is engaged. This could be very harmful for both the machine and the tractor itself.

When choosing how much to break up the soil which is to be rotary hoed the following points must be considered:

- The type of soil (mixed, sandy, clay, etc.);
- Working depth;
- The forward moving speed of the tractor;
- The optimal position of the machine.

Then the earth is best broken up and machine with a slow forward moving speed of the tractor, with the bed former lowered. As well as holding the soil that has already been hoed by the hoe blades the bed former helps to produce a well levelled and smooth surface after hoeing.

If the bed former is raised the sods are no longer broken up and there will not be a smooth, level finish.

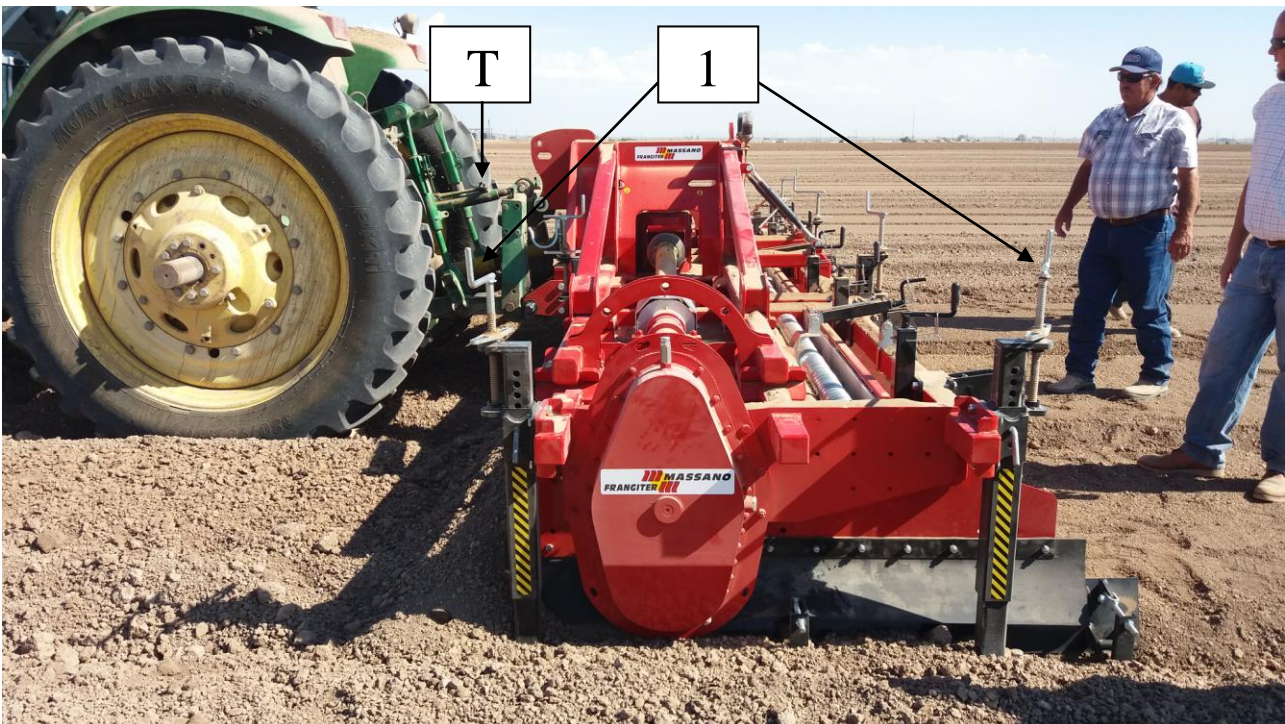

After going on with the machine for ¼ mile, familiarize with it in order to find the right engine speed of the tractor to ensure the optimal functioning of the machine.

Check that the machine is parallel to the ground or lightly lifted on the front during work. In order to do this operation act on tractor's third point (T). Furthermore check that the working depth is correct for the work you have to do, if it is not act on cranks number 1.

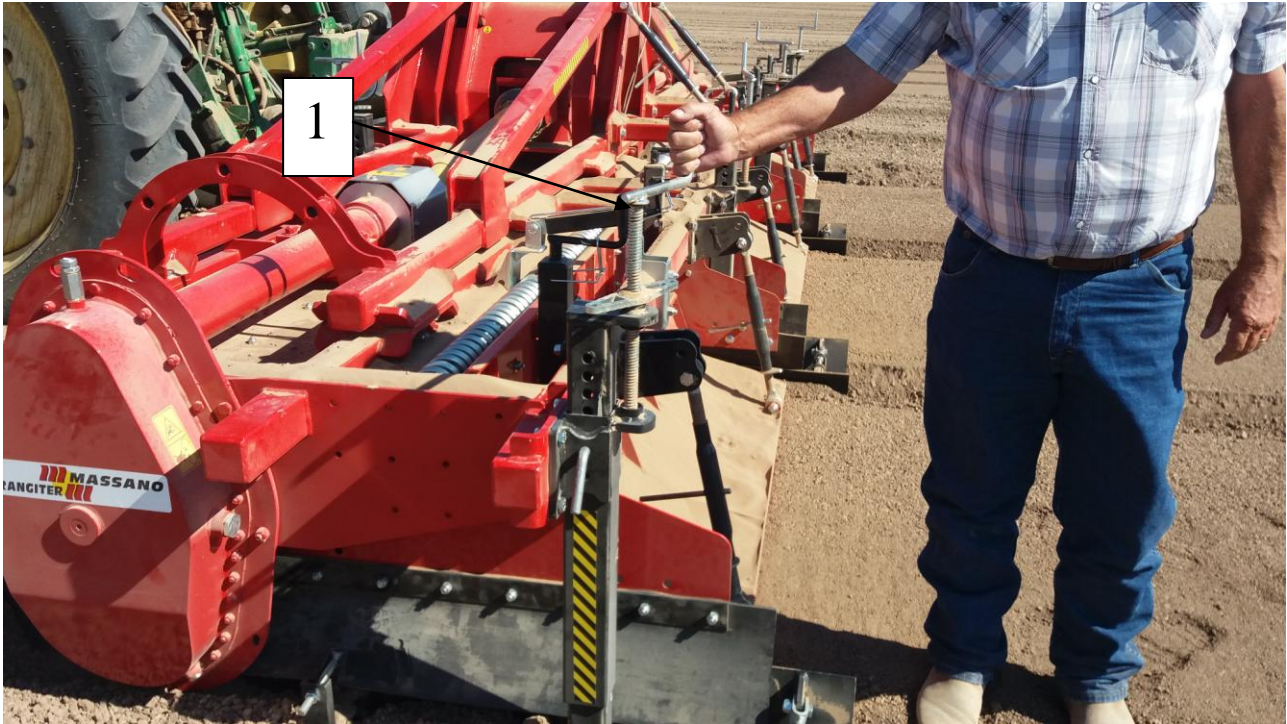

Cranks number 1 situated on each pontoon are necessary to change Reverse Tiller's working depth. Acting equally on the 8 cranks of the machine you can achieve the following result:

- A) Screwing the crank (clockwise rotation) the pontoon approaches to the blades rotor increasing the working depth.
- B) Unscrewing the crank (anticlockwise rotation) the pontoon distances from the blades rotor reducing the working depth.
- C) After checking the depth, lock the cranks with the lock nut (C) designed in order to not lose the cranks during work.

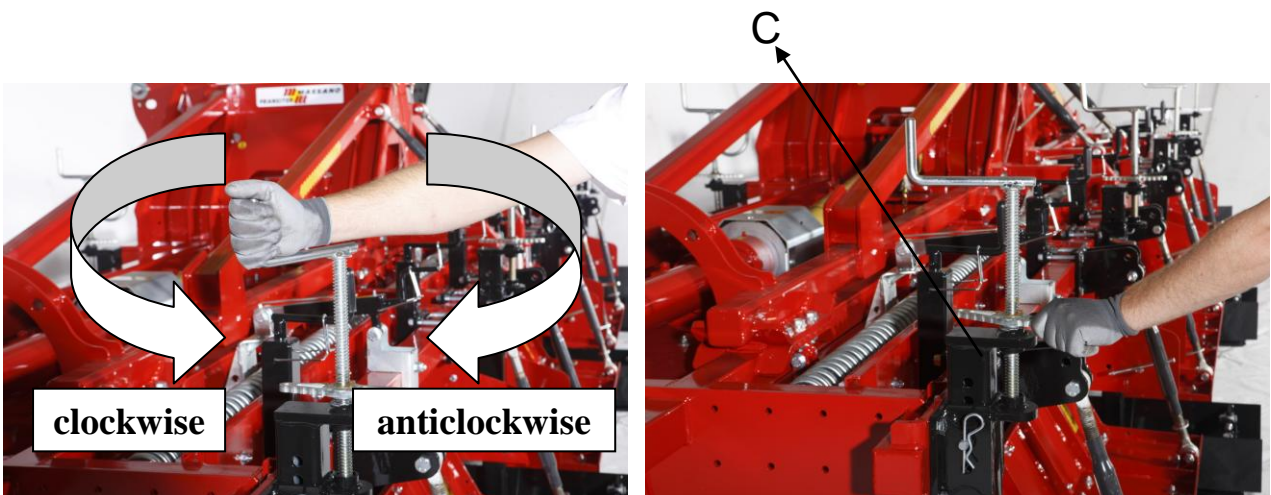



Then act on the adjustment screws “D” adjusting the bed former shaper’s height according to the working depth previously decided.

This operation must be done on each bed former shaper’s adjustment crank.



Adjust at the same time the crank “D” to the tensioner “E” that change the working degree of the bed former shaper. In order to obtain a good soil finishing it is suggested to position always the bed former shaper lightly lifted on the front to avoid the bed former to drag a large quantity of earth (see the following drawing).

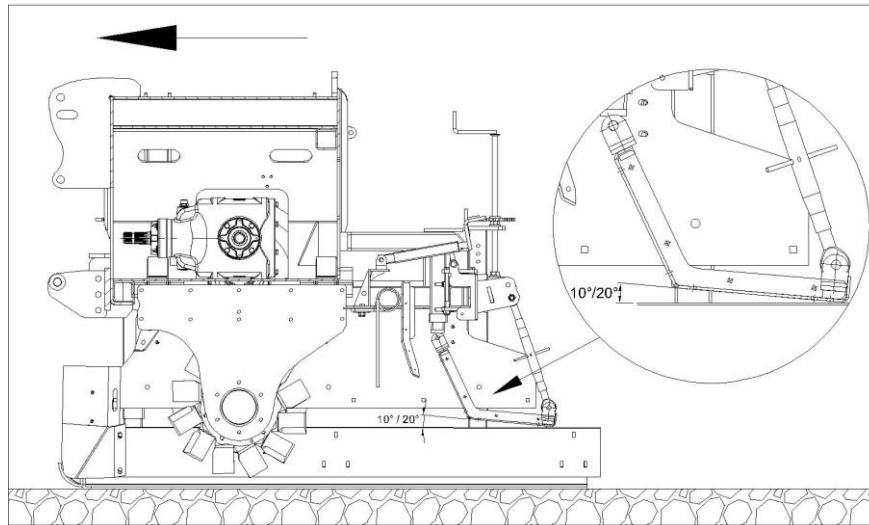

As you can see in this drawing the bed former shaper directs the earth towards the pontoons in order to obtain a bed without clods and vegetable residues. It is important to maintain the front part lightly lifted to help the entry of the broken up earth avoiding obstructions due to a too large quantity of earth worked by the rotor. Keep a bed former's working angle of 10-20°.



According to the type of soil act on crank "F" to determine the working angle of the sieve "G". The sieve is composed by springs that during work permit to bury the biggest clods and the vegetable residues allowing the flow of the fine earth that guarantees a layer without impurities and good for seeding or transplanting.

The inclination of the sieve "G" is proportional to two main elements: 1) the more the soil is wet, the greater will be the inclination; 2) the more the working depth is, the greater will be its inclination.



Check that the three bed former shapers are aligned over the same axle in order to guarantee a seedbed parallel to the ground.

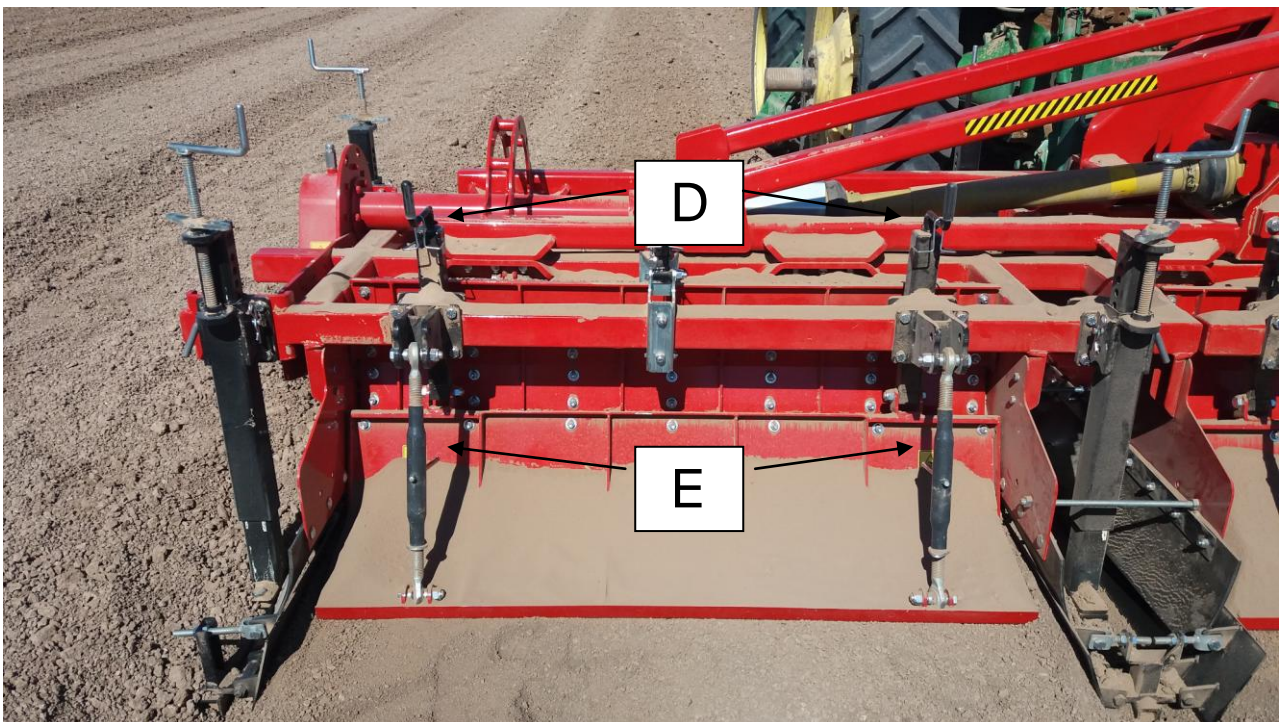

Bed former shaper left side.

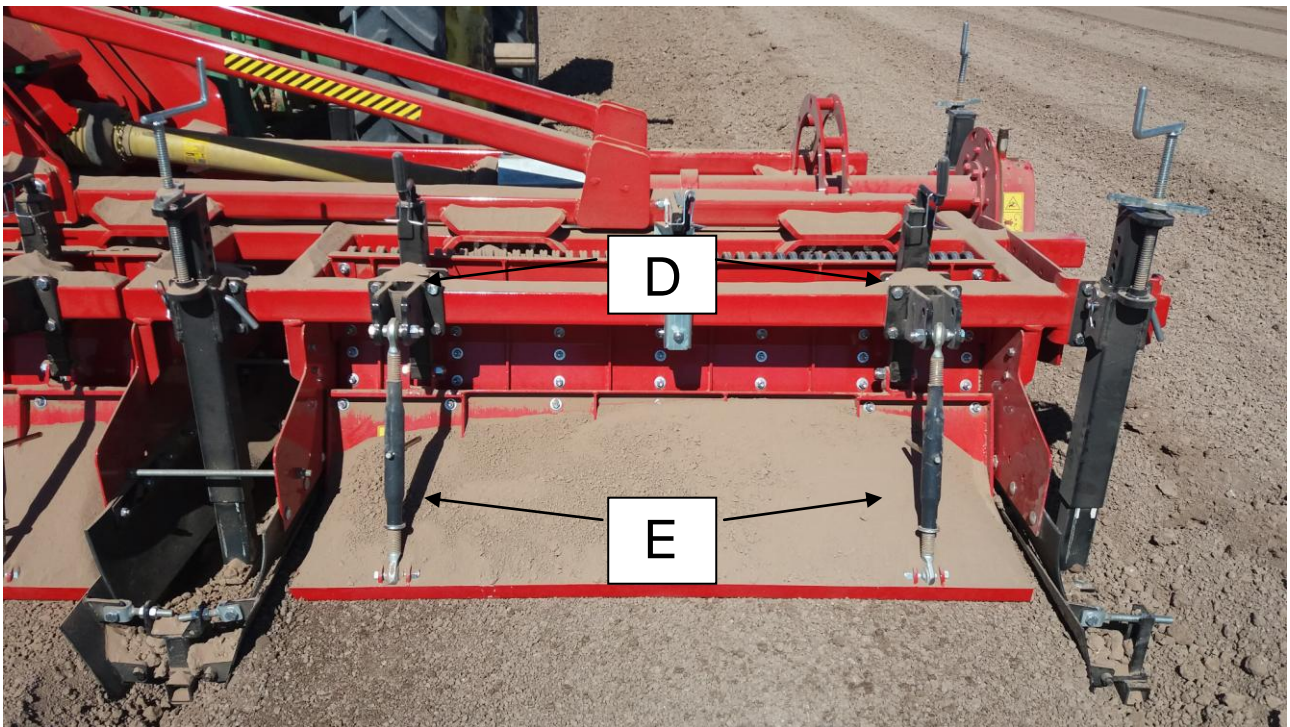

Bed former shaper right side. All three bed former shapers have to be aligned over the same axle. If this parallelism is not homogeneous act separately on each adjustment cranks (D-E).

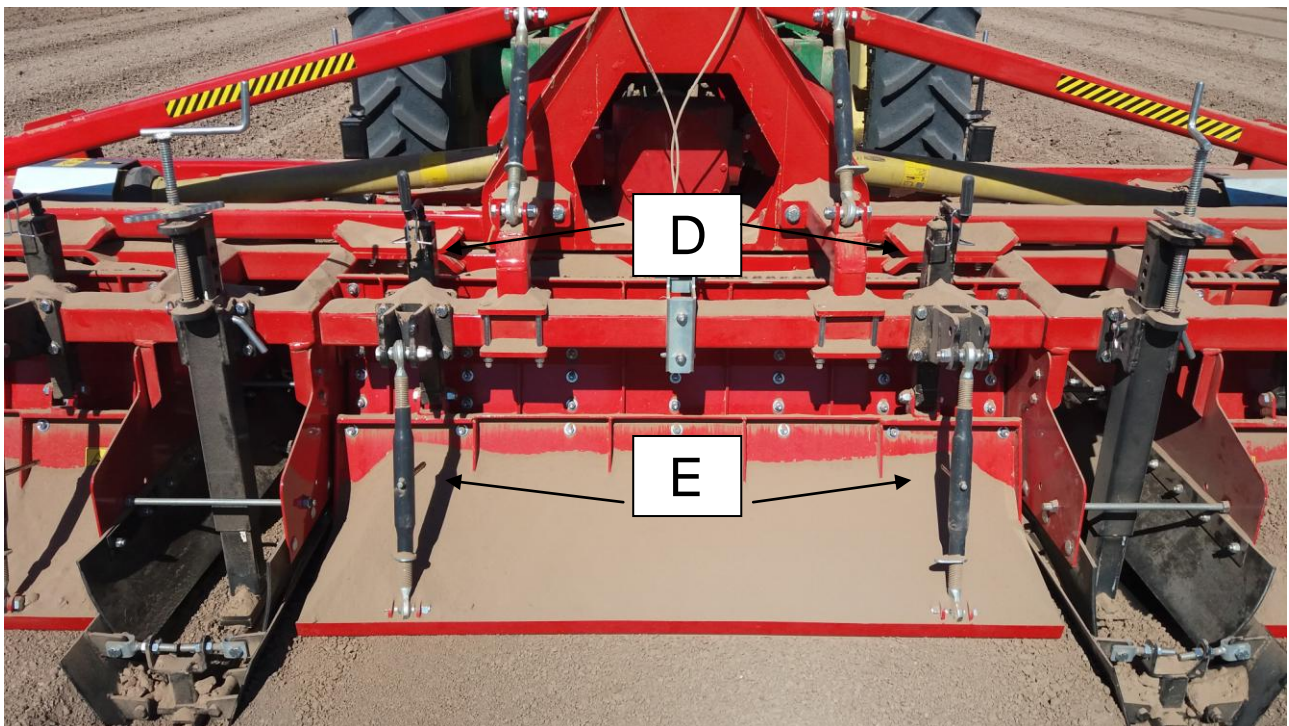

Central bed former shaper.



The large amount of clods to finish and the high hardness of the soil are the best conditions to use the Reverse Tiller in order to obtain a good seedbed.





A right adjustment and a tractor's speed correlated to the result you want to obtain allow you to drastically reduce costs due to the use of old machines which gave you the same result with several passes.



The achievement of a bed composed by layers of fine soil from the top to the bottom is a good compromise for the growing of seeded or transplanted crops. This situation makes the ground draining and allows the radical apparatus to find its perfect habitat favouring a quick germination and removing the risks of plant's asphyxia.



When you have finished to work or during the day check always to have enough grease for the next day. Otherwise go to the greasing position with a manual pump and fill the proper tank.



ATTENTION!

Do not exaggerate with grease's quantity because the tank has got a spring that act as a plunger. If this spring is too compressed, it risks to break the top cap of the tank causing a leak of grease.

Check periodically the grease's lowering, in case it doesn't happens it is suggest to check the small wheels (A) that determine the quantity of grease to send to the support. These small wheels are mounted on spring and they adjust the quantity of grease that flow through the tube; sometimes vibrations or dust can compromise their functioning.

Before stocking up the machine it is suggested to dismantle and clean the small wheels in order to achieve the best result.

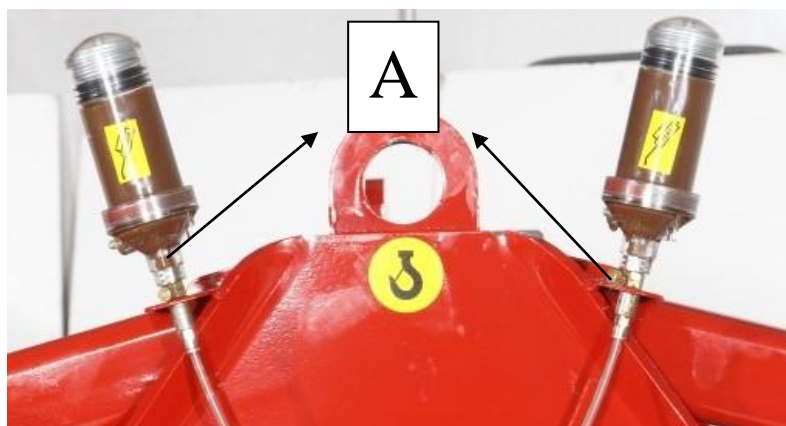

11. USE OF THE MACHINE.

ATTENTION!

Use always appropriate personal protective devices (safety shoes, work gloves, casing for hearing protection and anti- dust mask).

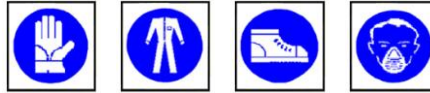

Before using the machine make sure that there are no people or animals within 50 meters.

CAUTION!



In order to prevent breakages or damage, the speed engine of the tractor must never exceed 8 km/hour when the machine is working.

CAUTION!



Never allow the machine to operate out of the soil.
 During work, avoid turning corners while the machine is working the soil. Never work in reverse.
 Always raise the machine in order to reverse or change direction.
 During transport, or whenever the machine must be raised, it is advisable to adjust the lift unit of the tractor so that the machine is not raised more than about 14 inches from the ground.
 Do not drive on public highways if the machine is dirtied with soil, grass or anything else that could dirty and/or hamper the road traffic.
 Lower the machine slowly to allow the blades to gradually penetrate the soil.
 Do not allow it to drop violently on the ground.
 To do this would strongly stress all the machine components and could damage them.

DANGER!

**Stones or other sharp objects may be thrown up by the turning blades during the soil working phase.
Always constantly check that there are no persons, children or domestic animals in the field of action of the machine.
The operator must also pay attention to the above.**

Before starting work, it is necessary to adjust the machine in the right way.

For optimal work conditions, act on the third point to incline the Reverse Tiller $\frac{1}{2}$ or 1 inch back, taking the height of the side pontoon as benchmark (the front should be $\frac{1}{2}$ or 1 inch higher than the back).

Start working. Let the Reverse Tiller gradually sink into the ground.

Do not step on the accelerator irresponsibly while P.t.o. is engaged, because this could be harmful to the Reverse Tiller and the tractor.

Crumble the soil at low running speed, with the levelling bonnet down and hoe-rotor rotation by 280/300 rev/1'.

The function of the bed former is, besides containing the worked clods, also to leave a levelled ground. If the bed former is open, clods will not get crumbled and the soil will not be levelled.

In case of rocky soil, we recommend that you remove stones bigger than 10 inches, which could cause machine abnormalities .

When working in such conditions, we suggest you to regulate the depth of work according to the result you want achieve.

A low running speed and a great working depth of the rotor can improve the performance.

DANGER!

During work stones and other objects on the ground or by the rotating hoes could be thrown up.

Always make sure that there are no people near the machine.

Before changing direction or turning, disconnect P.t.o. and lift the machine.

The machine can raise dust during work. We suggest you to use tractors with cabin equipped with filters in the ventilation system and suitable protections e.g. anti- dust mask or mask with filter .

The extended use of the machine may cause gearbox warming.

Before touching the gearbox, make sure it has become cold in order to prevent burning.

If the gearbox's superheating persists we suggest you to contact your dealer in order to buy an oil cooler system.

12. CONICAL ROLLER BED-SHAPER

Massano Snc has also designed a bed shaper version equipped with motorized conical roller. This device is used to tamp the shaped bed on the side and on the surface by means of moving cones that are controlled by an orbital engine.

This type of roller is especially used in sandy soils, where tamping is more difficult. But it is also suitable in clayey soils.

The roller's rotation has to be adjusted during work by means of the adjusting valve or acting on the distributor of the tractor, by increasing / decreasing oil level.

To achieve the best result, the roller rev number has to be proportional to the tractor's running speed. In case of extremely wet soil, we recommend to increase the rotation speed, otherwise in case of dry and dusty soil, you have to reduce the rotation speed to the minimum.

Massano Snc suggest you to use the roller on a moist ground, because this ground's particular condition helps shaping the bed avoiding the crushing of the bed during the sowing.

Do the following operation, when using a Reverse Tiller supplied with hydraulic motorized roller :

1. Before starting work lift the motorized rollers at the maximum height avoiding that they get in touch with the ground.

ATTENTION!

See the following information to adjust the roller during work.

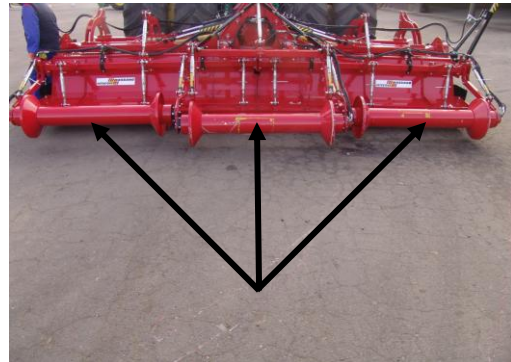

2. Begin work with the P.t.o. at running rate (1000 rpm), gradually lowering the machine into the soil. Avoid press down on the accelerator pedal to an excessive extent when the P.t.o. is engaged. Go forward with the machine for a short distance, then check to have achieved a correct bed according to your need. Now lower the roller and go on working.



In this case the roller works by means of an hydraulic engine and not by means of the tractor. The hydraulic engine creates a roller's circular movement in the same direction of the tractor. By means of the flow's regulator inside the tractor it is possible to adjust the number of revolutions and consequently the soil's compactness.

It is advisable to keep a higher or lower tractor's speed in order to allow the roller to clean itself.

3. To adjust compactness' degree and the bed shaping's height, act on the side screws that adjust the height of the roller.



4. Use the special tensioner to adjust the selection grill according to the working depth and the moisture of the soil. In case of dry soil, the grill must be perpendicular to the ground (closed position), in this way the grill, acting as a sieve, separates stones, clods and vegetable residues from the fine soil. If you want to increase the working depth, it is recommended to incline the grill, in order to reduce the tractor's stress. In wet soil conditions, we suggest you to open the selection grill, to avoid any stoppage.

If there are vegetable residues on the ground, we suggest you to increase the working angle of the sieve to prevent obstructions, particularly on the top of the springs.



12.1. Rear hydraulic roller

In case you want realize multiple beds we suggest you to follow the instructions below:



According to the planting surface (A) you need, adjust the plowshares on the bed former.

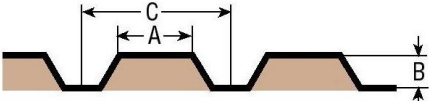



Use a square tool positioned on the side of the ploughshare (see photos above) and slide the cone bringing it in contact with the square. After doing this operation tighten firmly the screws using a pneumatic ratchet wrench. Repeat the same operation for the opposite cone and for all other cones in case your machine has more than a single bed. At the end check with a rule the distance between the two cones, it must be equal to the sowing seedbed (A).

13. MAINTENANCE

Follow you can find the suggested criteria for the routine maintenance of the machine, based on our business experience, advices and suggestions of our customers.

These criteria are not exhaustive, they can be further integrated with the cooperation of the customers we thank in advance.

A good maintenance allows to make the most of machine's potential.

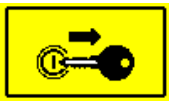

In case of failure, stop immediately the P.t.o., switch off the tractor, pull the handbrake, remove the ignition key, get off the tractor to check the problem and eventually intervene on the machine.

Preliminary notes

Before using the nipples heads, you must previously clean them carefully from mud or other debris, in order to inject lubricating grease:

Before starting maintenance, you must do the following operations:

- Disconnect the tractor's P.t.o.;
- Switch off the tractor's engine, pull the handbrake and remove the ignition key from the dashboard;
- Use always the appropriate personal protective device (safety shoes, work gloves, eye protection);
- Use suitable support systems correctly sized before operating below suspended parts taking into account their mass.

After the first 8 hours work carry out systematically the following checks and adjustments:

- The tightening of screws and nuts;
- The check tools' wear and entirety;
- The entirety of the guards;
- Check the oil levels;
- The greasing of the parts marked by the special sticker.



13.1 ORDINARY MAINTENANCE

To ensure a good functioning of the machine, follow the rules below.



ATTENTION!
Do maintenance on the machine when it has been disconnected from the tractor, lying on safety supports.

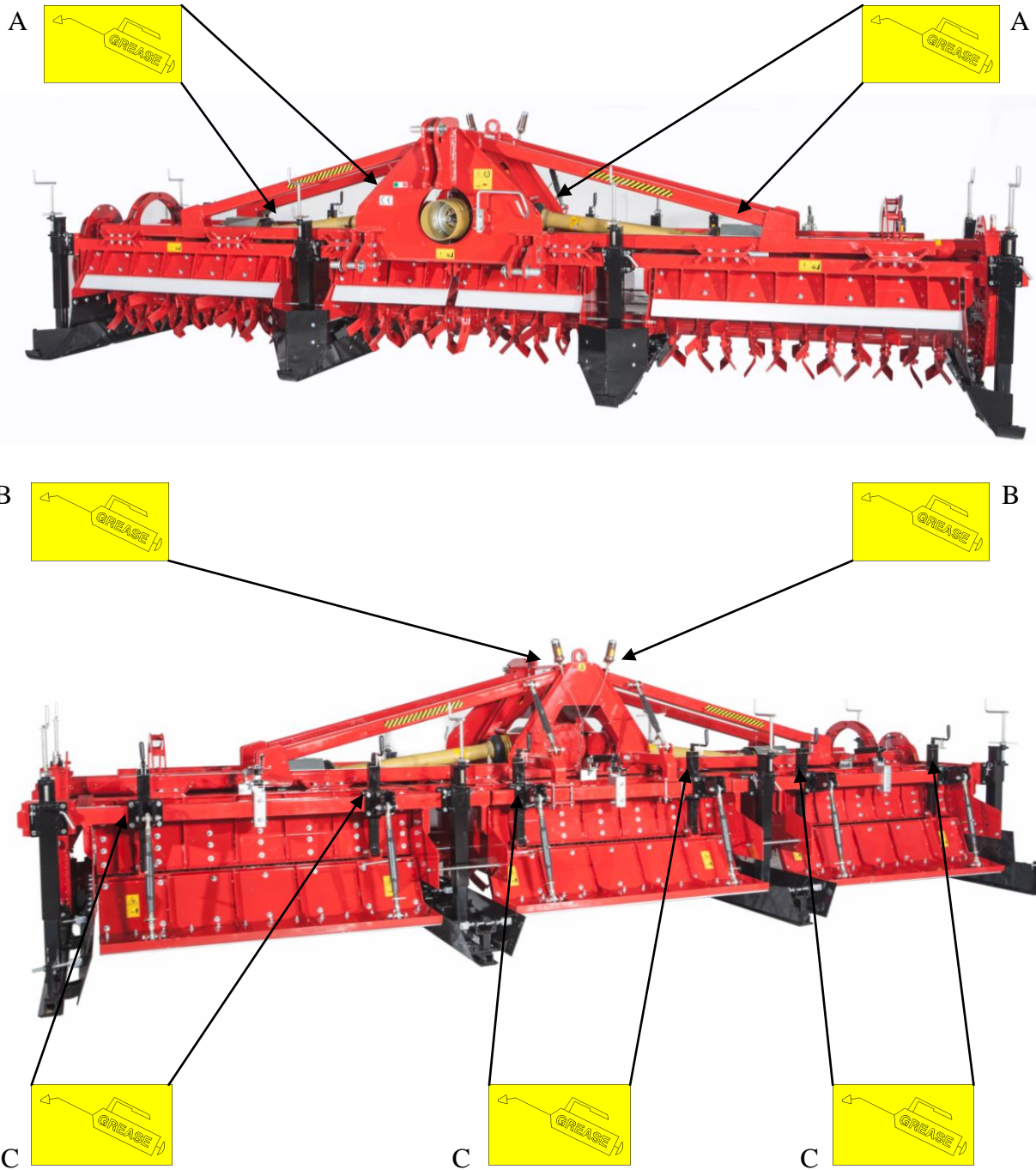

13.1.1 Greasing's Time

A: cardan shaft's crosses. After the first 8 hours work check the grease level inside the crosses' bearings. If necessary add the grease with the manual pump. After this first step check the grease level every 100 hours work.

B: check the grease every day from tractor's cabin (see page 39).

C: check every 50 hours work.

Grease a component only after removing carefully of debris and dirt. The presence of dirt in the injected grease could cause serious damage due to the great abrasive capacity of the ground.



Here you can find the greasing points of side cardan shaft's crosses.
Please check point A on page 45.

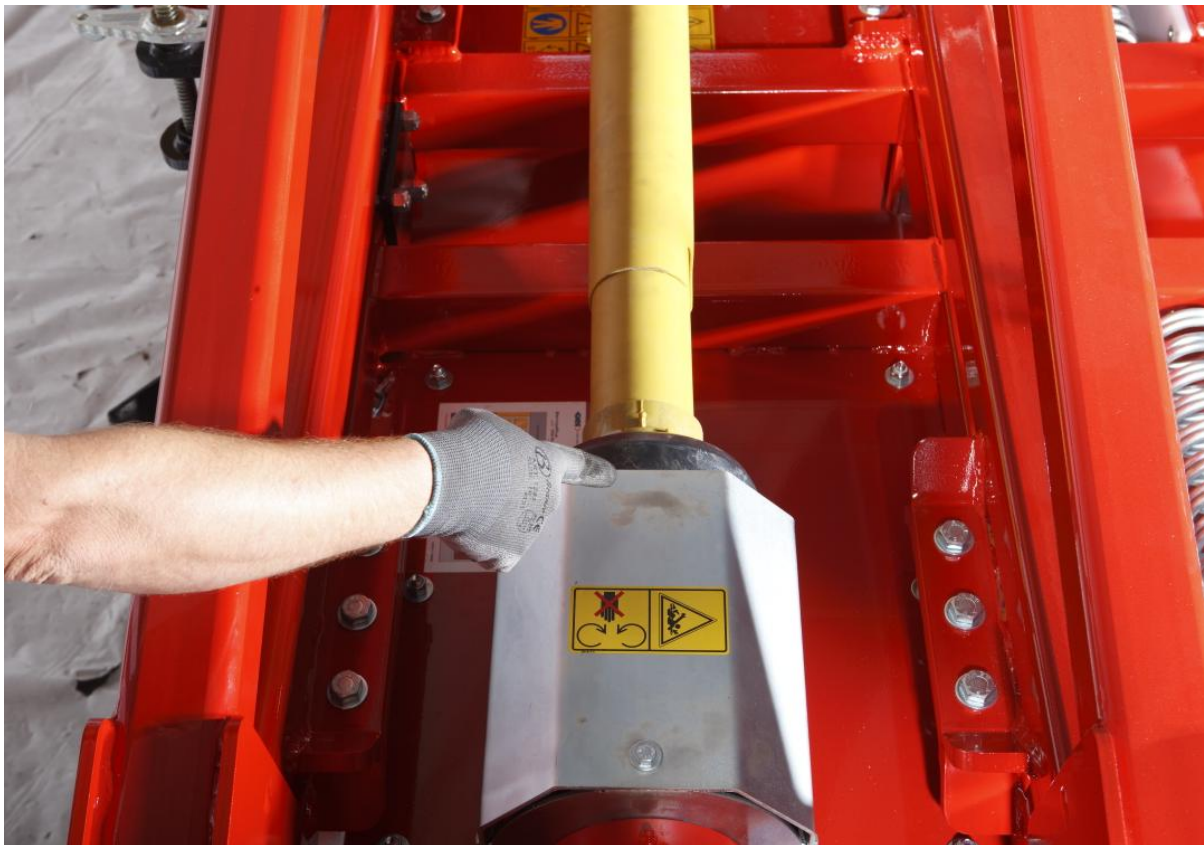



After the first 8 hours work check with a manual pump the amount of grease inside the house bearing. If necessary add grease until you become aware of a pump's stress. After that repeat this operation every 24 hours work.

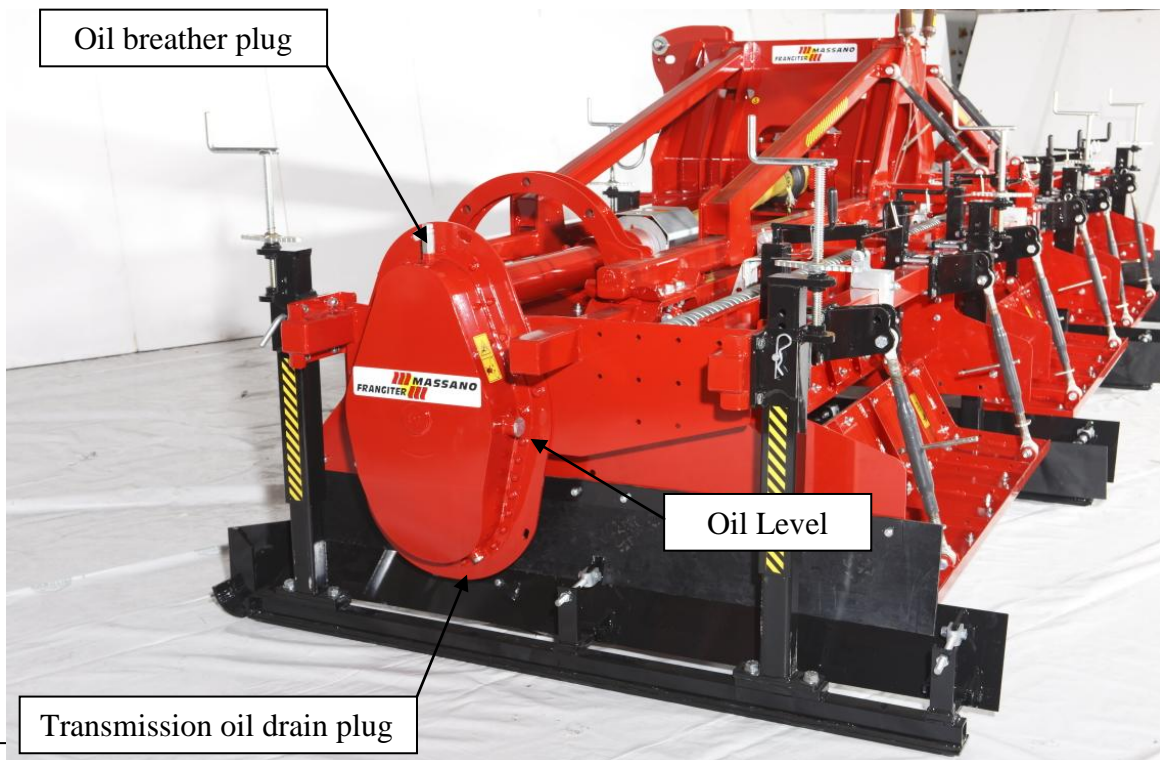

13.2 Every 50 hours work

- Check the amount of oil in the side gearbox and if necessary add oil.
- Check the level of oil in the central gearbox.

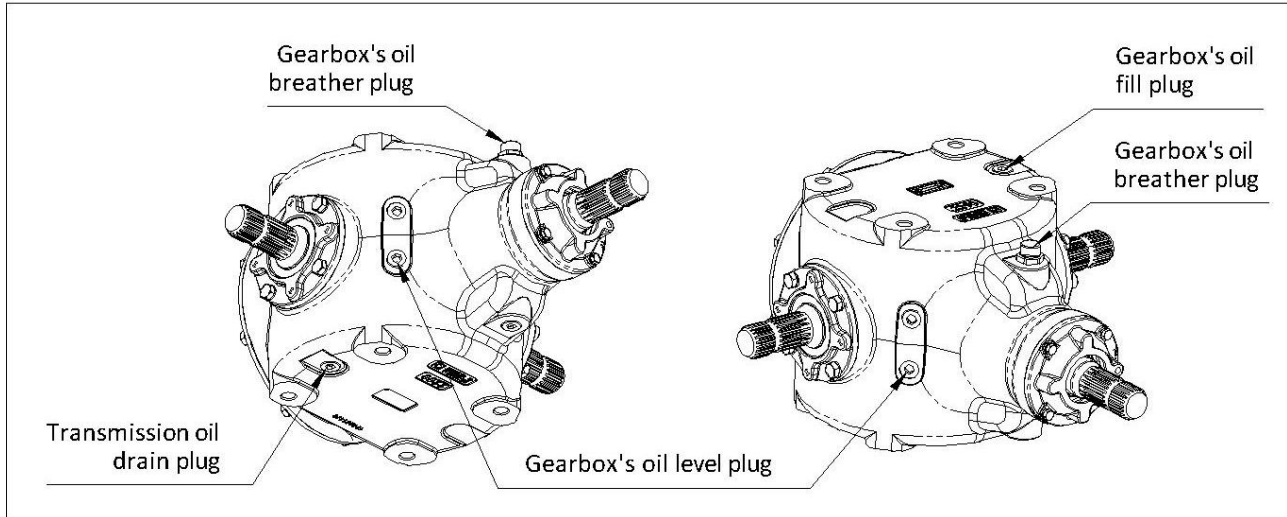

13.3 Recommended lubricant:

According to the weather temperature in California we suggest you to use a special synthetic oil. This oil can stand to high temperatures without losing its viscosity.

- Central gearbox and the side transmission: TOTAL ERG CARTER SH 220
- Greasing points: Grease SHELL RETIMAX WB2 or equivalent.
- Grease for cardan shaft: Grease SHELL GADUS S3 V220C or equivalent.

For technical specifications on lubricating oils and greases refer to the following table:

Mod.	Reduction unit	Side drive
REVERSE TILLER – RSE-PLUS.2	6,5 Kg	9 kg Left + 9 kg Right

13.4 Every 250 hours of work

- We suggest you to clean the gearbox with solvent or diesel, and replace oil using TOTAL ERG CARTER SH 220.
- We suggest you to clean the side gears casing with solvent or diesel, and replace oil using TOTAL ERG CARTER SH 220.
- It is also necessary to disassemble and clean the cardan shaft clutch discs (see cardan shaft's book)

14. ROTOR WITH BLADES

The blades worn out or broken must be replaced using MASSANO high strength bolts and nuts CL. 10.9. When replacing careful to maintain the previous arrangement.

After the first 8 hours work check the tightness of the bolts securing the blades on the rotor's flanges. Then do this check operation every 100 hour work.

14.1 REPLACEMENT OF BLADES

The replacement of the blades must be made by placing the Reverse Tiller on two solid side supports correctly sized taking into account the mass of the machine reported on the rating plate and in this User and Maintenance Book under the section "Technical features".

The replacement must be done keeping the machine and especially the drive shaft disconnected from the tractor.

To remove the blade unscrew and remove the nut with a wrench, then remove the bolt, and the worn blade you have to replace.

Place the new blade near the connection holes, insert the bolt, the nut and tighten vigorously at a torque of 240 N/m.

The heads of the bolts fixing the hoe blades in place must be on the side of the hoe blades themselves, while the nut with must be on the flange side.

Follow the instructions below:



Position yourself in front of the Reverse Tiller. Start from the left side dismantling the worn blade number 1 and replace it with a new one turned on the right. Then go down and repeat the same operation for blades number 2-3-4 etc. When you have finished the replacement you can see a spiral that determine the right position of blades turned on the right. Now dismantle all the other blades and continue the spiral above or under the blade number 1 making a spiral with the blade turned on the left. Repeat this operation 4 times alternating right and left at every start, in this way you will obtain a right mounted part of the rotor. The sharp part of the blade must always be turned on the top surface.

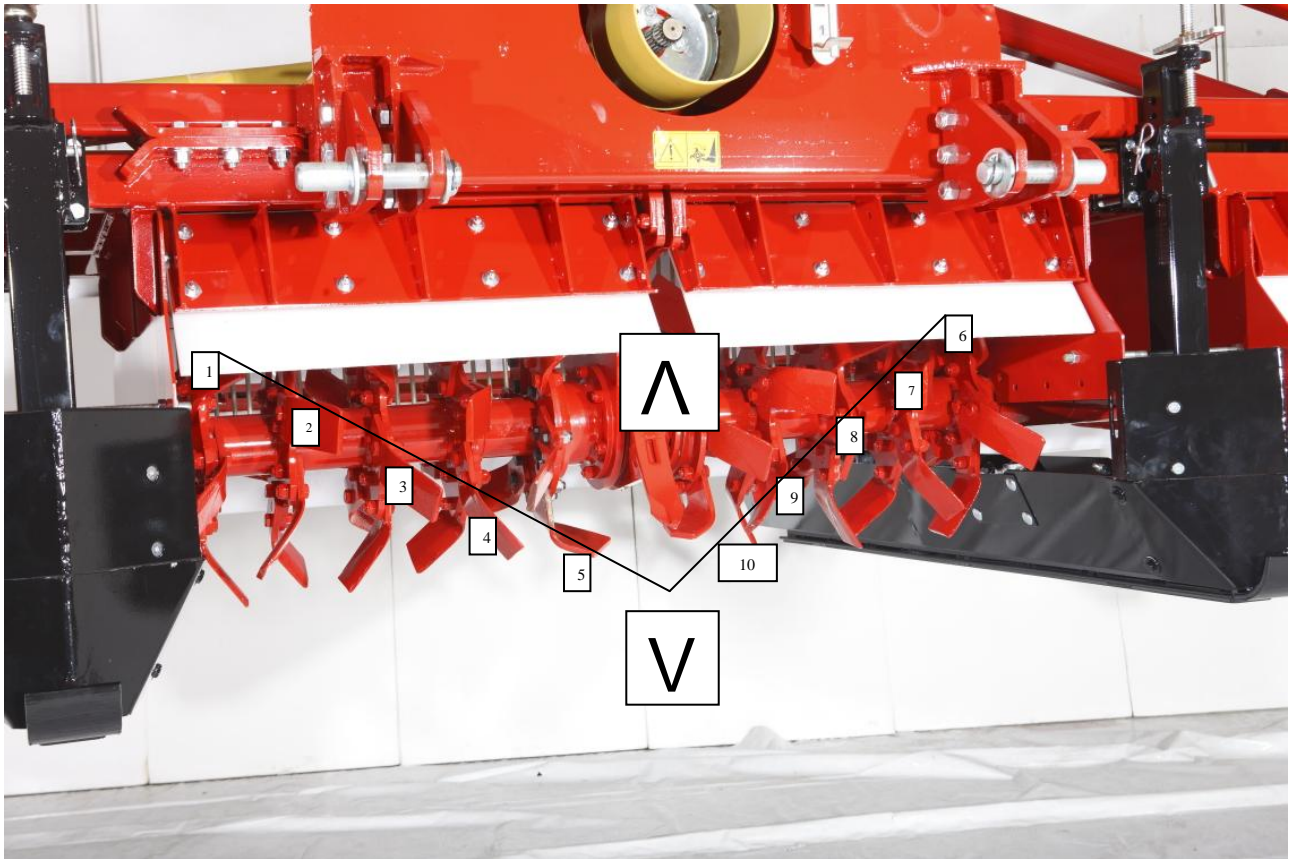

The blades' replacement of the central rotor is a little bit different from the previous one. Start from the left side dismantling the worn blade number 1 and replace it with a new one turned on the right. Then go down and repeat the same operation for blades number 2-3-4-5. Move to the right side of the Reverse Tiller and replace blade number 6 with a new one turned on the right. Then go down and repeat the same operation for blades number 7-8-9-10. When you have finished the replacement you can see a double spiral that determine the right position of all the blades turned on the right making a V profile (on the left rotor the blades go down while on the right rotor the blades rise, always starting from the centre). This is the difference between the two type of replacement. Now dismantle all the blades and continue the spiral above or under the blade number 1 making a spiral with the blade turned on the left side. Repeat this operation 4 times alternating right and left at every start, in this way you will obtain a right mounted second part of the rotor.



ATTENTION!

If positioning the blades of the central rotor you notice in the worked soil an accumulation of ground in the centre of the machine we suggest you to invert the position of the blades making a spiral opposite to the above mentioned one.



Finally repeat the same operation done for the first point for the right rotor. Start from the right side near the transmission by gears, dismantle the worn blade number 11 and replace it with a new one turned on the right. Then go down and repeat the same operation for blades number 12-13-14 etc. When you have finished the replacement you can see a spiral that determine the right position of all blades turned on the right side. Now dismantle all the other blades and continue the spiral above or under blade number 11 making a spiral with blade turned on the left. Repeat this operation 4 times alternating right and left at every start, in this way you will obtain a right mounted part of the rotor.

Worn blades have to be replaced. We suggest you to replace also partially broken blades and, at the same time, their diametrically opposed components, in order to maintain balancing.

When you have replaced all the blades check that the tightening torque is suitable for the lock screws.

M 16x45x1,5 C.L. 10.9 = 240 N/m – See schedule below

Screw diameter	Mod.	Tightening values
∅ 16mm	REVERSE TILLER – RSE-PLUS.2	240N/m

15. ANALYSIS OF THE PROBLEMS, TROUBLES' SEARCH

PROBLEMS	CAUSES	SOLUTIONS
Uneven distribution	<ul style="list-style-type: none"> • Too damp ground • Incorrect placing of the tools • Uneven connection to the tractor 	<ul style="list-style-type: none"> • Wait for better conditions • Check the exact placing of the tools • Check the connection to the tractor
Noise level of the gearbox	<ul style="list-style-type: none"> • Inner anomalies • Worn bearings or gears • The machine tilts too far forward or backwards as it works 	<ul style="list-style-type: none"> • Contact Massano Snc or local dealer • Lengthen or shorten the third point hitch so that the upper surface of the machine is parallel to the ground worked (the P.t.o. connections of the tractor and machine must be parallel)
Excessive vibrations	<ul style="list-style-type: none"> • Wrong placing of the tools • Foreign object trapped between the tools 	<ul style="list-style-type: none"> • Check the exact placing of the tools • Remove the foreign object
Clutch slip	<ul style="list-style-type: none"> • Foreign object trapped between the tools • Excessive working depth 	<ul style="list-style-type: none"> • Remove the foreign object • Reduce the working depth
Premature wear of the tools	<ul style="list-style-type: none"> • Too clayey ground 	<ul style="list-style-type: none"> • Replace standard tools with special anti wear tools
Power draw too high on wet ground	<ul style="list-style-type: none"> • Too much soil worked • Soil working too deep • Levelling plate clogged • Rotor speed too fast 	<ul style="list-style-type: none"> • Reduce the working depth by adjusting the machine's depth skids or the pontoon • Raise the leveling plate to make the soil shift more easily • Reduce the P.t.o. of the tractor from 1000 rpm to 750 rpm

<p>Soil crumbled to an excessive extent</p>	<ul style="list-style-type: none"> • Levelling plate closed to an excessive extent • Ground speed too low • Rotor speed too fast 	<ul style="list-style-type: none"> • Raise the leveling plate to prevent the clods from being broken up to much • Increase the ground speed • Reduce the P.t.o. of the tractor from 1000 rpm to 750 rpm
<p>Soil broken into excessively large clods</p>	<ul style="list-style-type: none"> • Levelling plate open to an excessive extent • Ground speed too high • Soil too wet • Low rotor speed 	<ul style="list-style-type: none"> • Lower the leveling plate to break up the soil clods to a greater extent • Reduce the ground speed • Do not work soil that is too wet • Increase rotor speed (contact Massano Snc or its authorized dealer)
<p>Power draw too high on dry ground</p>	<ul style="list-style-type: none"> • Too much soil worked • Soil working too deep • Worn cultivator blades • Rotor speed too fast 	<ul style="list-style-type: none"> • Reduce the working depth by adjusting the machine's depth skids or the pontoon • Replace the complete set of cultivator blades to ensure that the rotor is stable • Reduce the P.t.o. of the tractor from 1000 rpm to 750 rpm
<p>Presence of crop rests on the surface</p>	<ul style="list-style-type: none"> • Too dense Vegetation • High pressure of the rear bed former • Rear grill with a too high working angle 	<ul style="list-style-type: none"> • Use a shredder to reduce vegetation • Reduce the rear bed former pressure acting on the handle • Reduce grill's working angle
<p>Excessive power demand</p>	<ul style="list-style-type: none"> • High working depth • Undersizing of the tractor • Worn cultivator blades 	<ul style="list-style-type: none"> • Reduce the working depth • Use tractor of adequate power • Replace the complete set of cultivator blades to ensure that the rotor is stable

16. GUARANTEE

16.1 DURATION OF THE GUARANTEE

The manufacturer guarantees that its products are free from material and manufacturing defects for twenty - four (24) months from the delivery date of the machine.

WARRANTY CONDITIONS

- 1) The obligation due to this warranty is limited to replacement and/ or repairing of components that, after inspection of one of our technicians, present material and manufacturing defects;
- 2) The damaged parts must not be changed, disassembled by unauthorized people, and also they must not have been subjected to misuse, negligence or accident;
- 3) The costs of manpower and transport for repairing or replacement of defective parts are not included in the guarantee;
- 4) The bearings and the oil retainers are not included in the guarantee;
- 5) The cardan shaft is not included in the guarantee;
- 6) No guarantee made by someone else than the manufacturer will be considered valid and binding;
- 7) The manufacturer reserves the right to make changes without warning, and, in this case, he does not assume any obligation to make such changes on products previously manufactured;
- 8) At delivery time check that the machine has not been damaged during transport and that it has got all parts, any claims must be done in writing within 8 days from the delivery date of the machine.

The warranty will be invalidated if:

- 1) The failure is due to a maneuver error;
- 2) The failure is due to repairing done by unauthorized staff or to the use of non original parts;
- 3) The customer has not follow the instructions contained in this book;
- 4) The customer exceeds the maximum allowed power shown in the technical features table;
- 5) The customer has not done an adequate maintenance in the clutch of the drive shaft.

17. SPARE PARTS

Spare parts should be ordered from your dealer and should always include the following indications:

- **Type, model and serial number of machine.** These data are punched on the data plate with which every machine is equipped.
- **Code number of the required spare parts.** This will be found in the spare parts catalogue.
- **Description of the part and required quantity.**
- **Table number.**

- **Means of dispatch.** If this item is not indicated, the Manufacturer, while dedicating particular care to this service, shall not be held responsible for delays in delivery caused by cases of force majeure.

Transport expenses shall always be at the consignee's charge. The goods travel at the purchaser's risk and danger even when sold ex destination.

NOTE: The terms Right or Left indicated in the descriptions refer to the machine when viewed from the rear side.