



THE ECO-DRILL
3-POINT MOUNTED NO-TILL DRILL
Models KED-72 and KED-96



170 West 600 North

Shelbyville, Indiana 46176

800.458.9129

www.kascomfg.com

THANK YOU!

You have invested in the best implement of its type on the market today.

The care you give your Kasco equipment will greatly determine your satisfaction with its performance and its service life. We urge a careful study of this manual to provide you with a thorough understanding of your new implement before operating, as well as suggestions for operation and maintenance.

If your manual should become lost or destroyed, Kasco will be glad to provide you with a new copy. Please call us at 1-800-458-9129, or visit our website for an downloadable copy.

Because Kasco maintains an ongoing program of product improvement, we reserve the right to make improvements in design or changes in specifications without incurring any obligation to install them on units previously sold.

RETAIL CUSTOMER'S RESPONSIBILITY

It is the Retail Customer and/or Operator's responsibility to read the Operator's Manual, to operate, maintain and store the product in accordance with all instructions and safety procedures. Failure of the operator to read the Operator's Manual is a misuse of this equipment.

It is the Retail Customer and/or Operator's responsibility to inspect the product and to have any part(s) repaired or replaced when continued operation would cause damage or excessive wear to the other parts or cause a safety hazard.

It is the Retail Customer and/or Operator's responsibility to contact Kasco immediately for any warranty claims. Claims for warranty consideration must be made within seven (7) days of failure.

It is the Retail Customer and/or Operator's responsibility for any cost incurred by the dealer for traveling to or hauling of the product for the purpose of performing a warranty obligation or inspection.



LIMITED WARRANTY

Kasco Mfg. Co., Inc. warrants all its products against defects in material and workmanship for one year after date of retail purchase, except those components not manufactured by Kasco, as those parts are warranted only to the extent of the original manufacturer's warranty.

Should any part manufactured by Kasco prove defective within one year from date of retail purchase, supposed defective part shall be returned freight paid to Kasco for consideration. If found to be defective by Kasco, credit will be issued through the proper channels, distributor and/or dealer.

Kasco will not assume liability for any labor costs, loss or damage caused by a defective part, consequential damages, or operational delays.

Altering or misuse of a part will void this warranty. Repairing a part without the expressed permission of Kasco voids this warranty.

Kasco neither assumes nor authorizes any person to assume for Kasco any other obligations or liability in connection with the sale of its equipment

Kasco reserves the right to make improvements in design or changes in specifications at any time without incurring any obligations to owners of equipment previously sold.

IMPORTANT SAFETY PRECAUTIONS

This symbol is used to call attention to safety precautions that should be followed by the operator to avoid accidents. When you see this symbol, carefully read the message that follows and heed its advice. Failure to comply with safety precautions could result in serious bodily injury.



Safety of the operator is one of the main concerns in designing and developing a piece of equipment. This product was designed by Kasco with as many safety features as possible. However, every year many accidents occur which could have been avoided by a few seconds of thought and a more careful approach to handling equipment. You, the operator, can avoid many accidents by observing the following precautions in this section. To avoid personal injury, study the following precautions and insist those working with you, and for you, follow them.

1. Read the Operator's Manual. Failure to read the Operator's Manual is considered a misuse of this equipment.
2. Become familiar with all the machine's controls and all the caution, warning, and danger decals affixed to the machine before attempting to start or operate.
3. Before starting or operating the machine, make a walk around inspection and check for obvious defects such as loose mounting bolts and damaged components. Correct any deficiency before starting.
4. Do not allow children to operate the implement. Do not allow adults to operate it without proper instruction.
5. Do not carry passengers.
6. Keep the area of operation clear of all persons, particularly small children and pets. The operator should cease operation whenever anyone comes within the area.
7. Lower the implement to the ground, stop tractor engine, and apply parking brake before leaving the vehicle.
8. Keep hands and feet away from implement.
9. Wear personal protective equipment such as, but not limited to, protection for eyes, ears, feet, hands, and head when operating or repairing the equipment. Do not wear loose clothing or jewelry that may catch on equipment's moving parts.
10. When performing adjustments or maintenance on the implement, first lower it to the ground or block it securely at a workable height.
11. Never stand between the tractor and implement when the tractor is being backed to the hitch.
12. Reduce speed when transporting implement to avoid bouncing and momentary loss of steering.
13. Use tractor flashing warning lights, day or night, when transporting implement on road or highways unless prohibited by law.
14. Use a rollover protective structure and seat belt equipped tractor for all implement operations.

INTRODUCTION AND DESCRIPTION

Introduction:

We are pleased to have you as a Kasco customer. We have engineered your Eco-Drill to provide our customers with the best performance with the least maintenance and down-time possible. Please read this manual completely and understand the operation of the Eco-Drill before using. Observe and obey all safety precautions noted. If you need any information, please contact us at 1-800-458-9129.

Description:

The Kasco Eco-Drill is intended for planting in no-till or min-till conditions, in an environment relatively clear of rocks and debris. Every Eco-Drill is equipped with a chain guard covering the drive-chain. This chain guard must be in place for proper use.

PREPARATION FOR USE



WARNING: To avoid serious injury or death, never stand between tractor and drill/ seeder while tractor is being backed to hitch.



WARNING: To avoid serious injury or death, additional tractor front ballast may be needed for stable operation and transport of the drill/seeder. See tractor operator's manual for recommended weights.

- 1) Carefully and thoroughly read this owners manual.
- 2) Attach the Eco-Drill to the tractor you will be using.
- 3) Adjust the top link until the frame of the Eco-Drill is level.
- 4) Select what seed type you want to plant.
- 5) Examine the seed chart to determine the required setting for your selected seed type.
- 6) Set the drive chain in the gearbox. (Refer to illustration).
- 7) Loosen wing-nut locking seed meter handle. Pull handle to appropriate opening width (tape gauge is located on the side of the hopper). Tighten handle wing-nut to lock into place.
- 8) Set the depth control (Refer to illustration).
- 9) After setting the machine, make a trial pass to ensure the machine is working correctly.

MODEL KED-96 ECO-DRILL

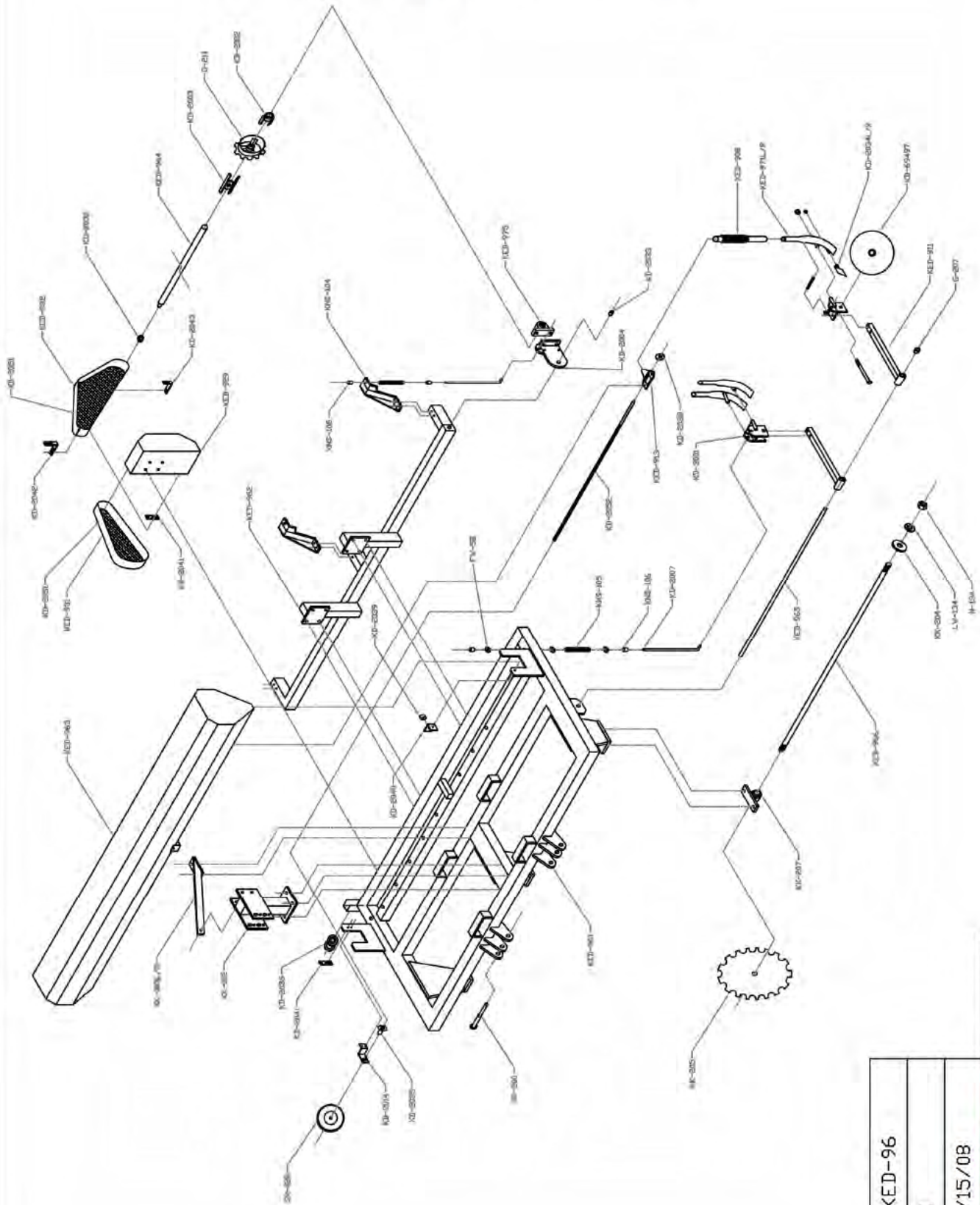

Model# KED-96	Scale: 1-1
Rev. # 1	User: JH
Date: 8/15/08	

Hopper Handle Assembly

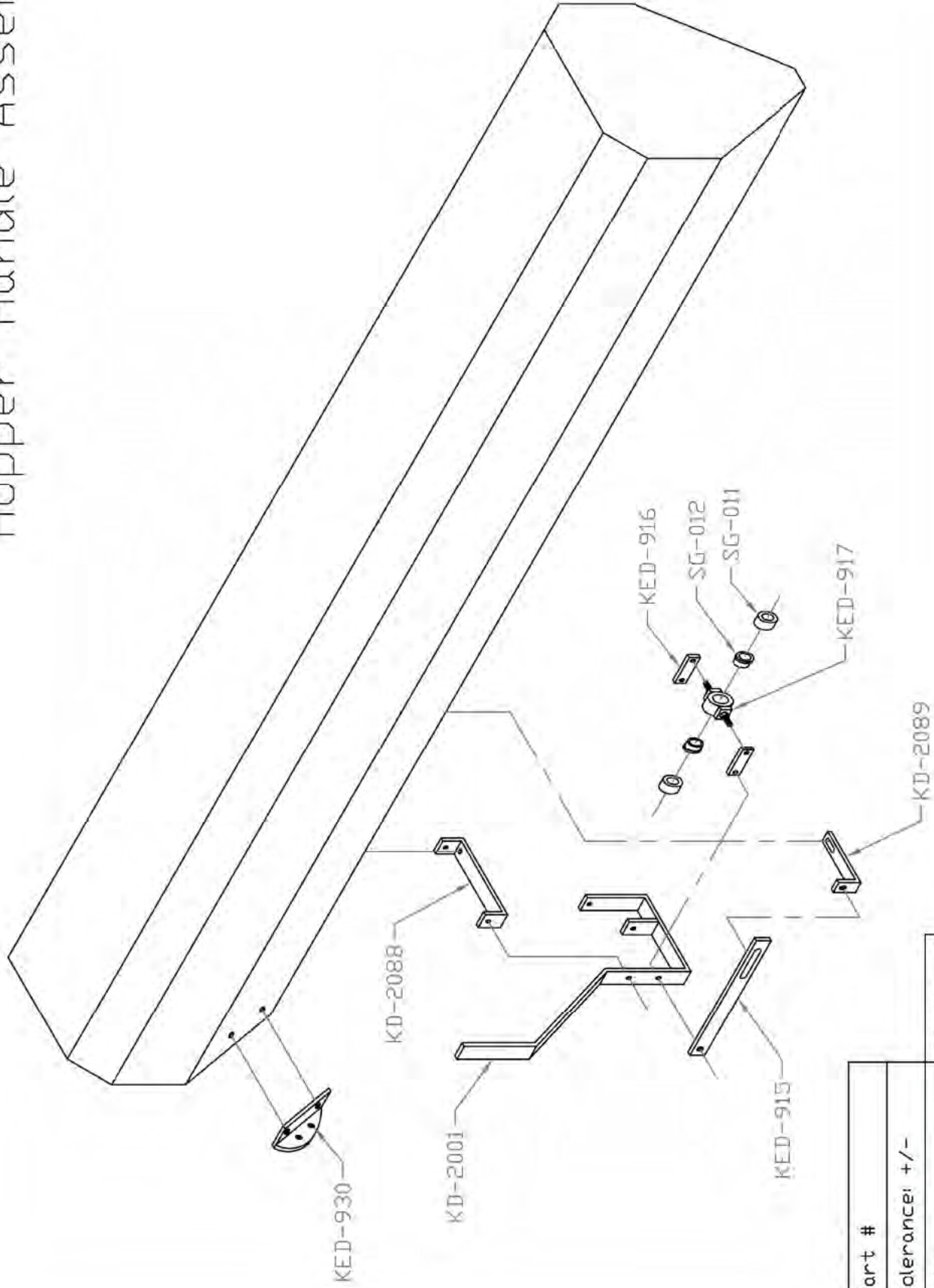

Part #	Rev #
Tolerance: +/-	Scale:
Date:	User:

Gearbox

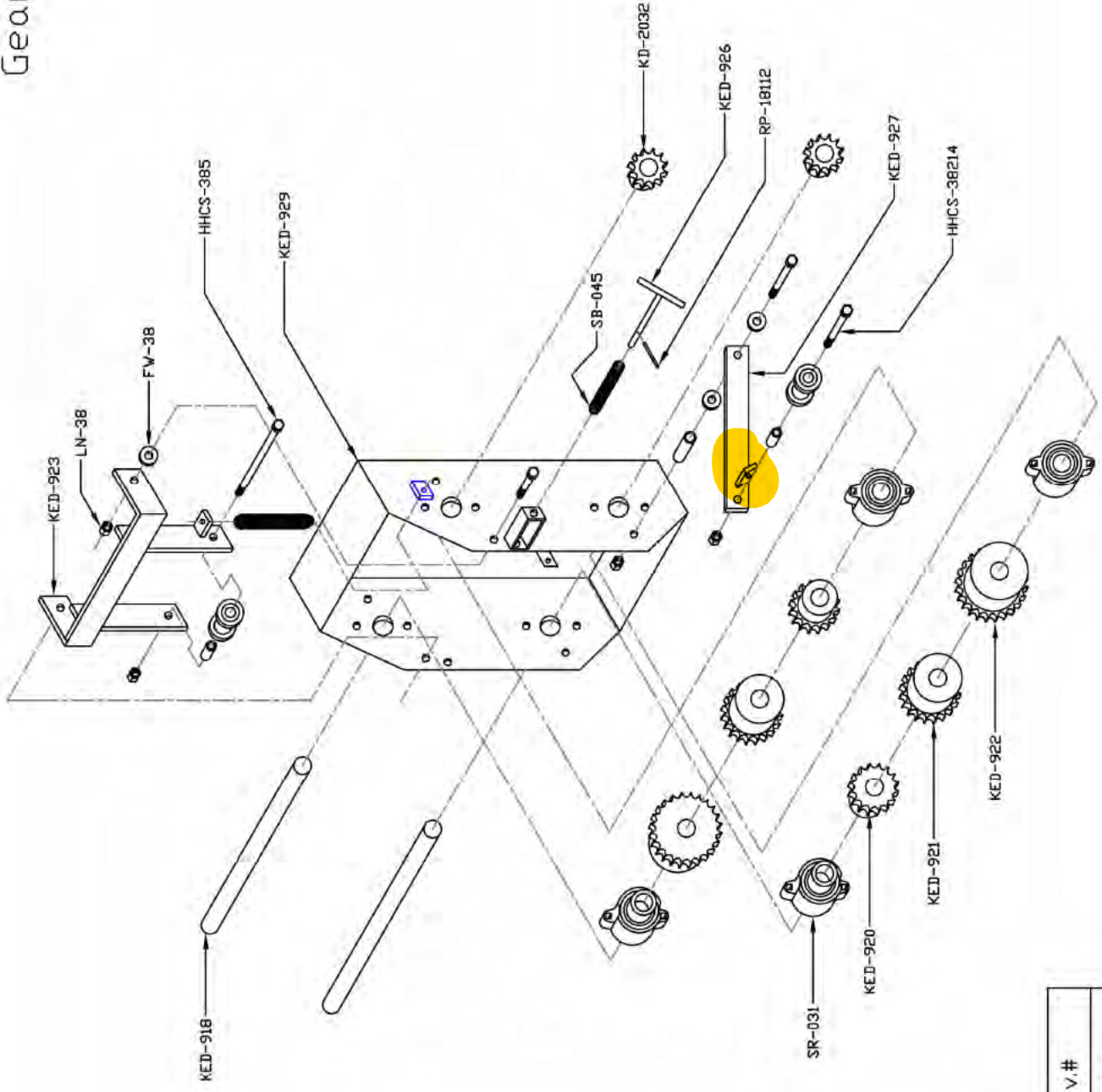

Part #	Rev.#
Tolerance: +/-	Scale:
Date: 7/15/08	User: JH

KASCO MFG. CO. INC.
 SHELBYVILLE INDIANA

Model# KED-120
 Rev. # 1
 Date: 1/15/13

Scale: 1-1
 User: JH

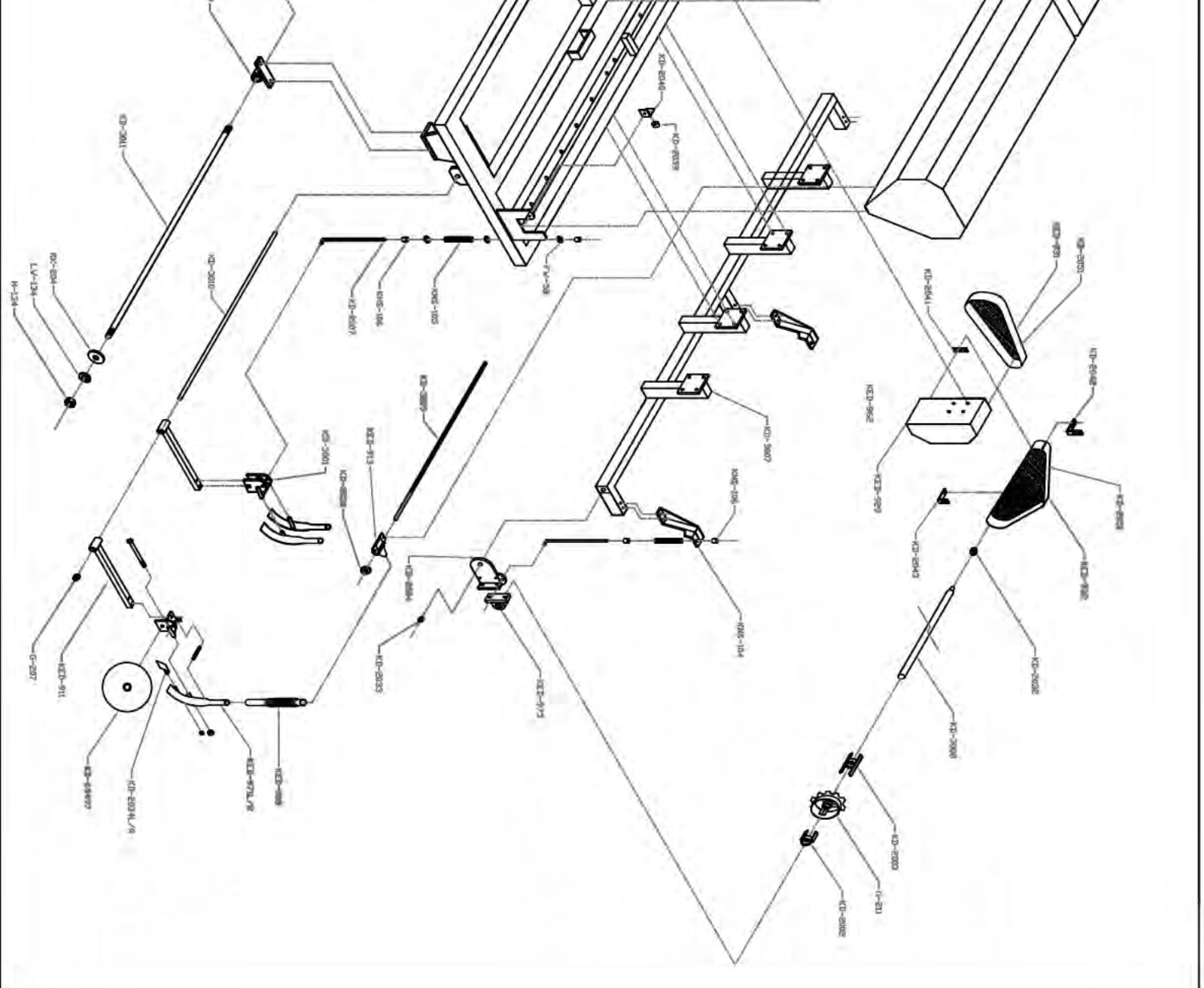

METER SYSTEM

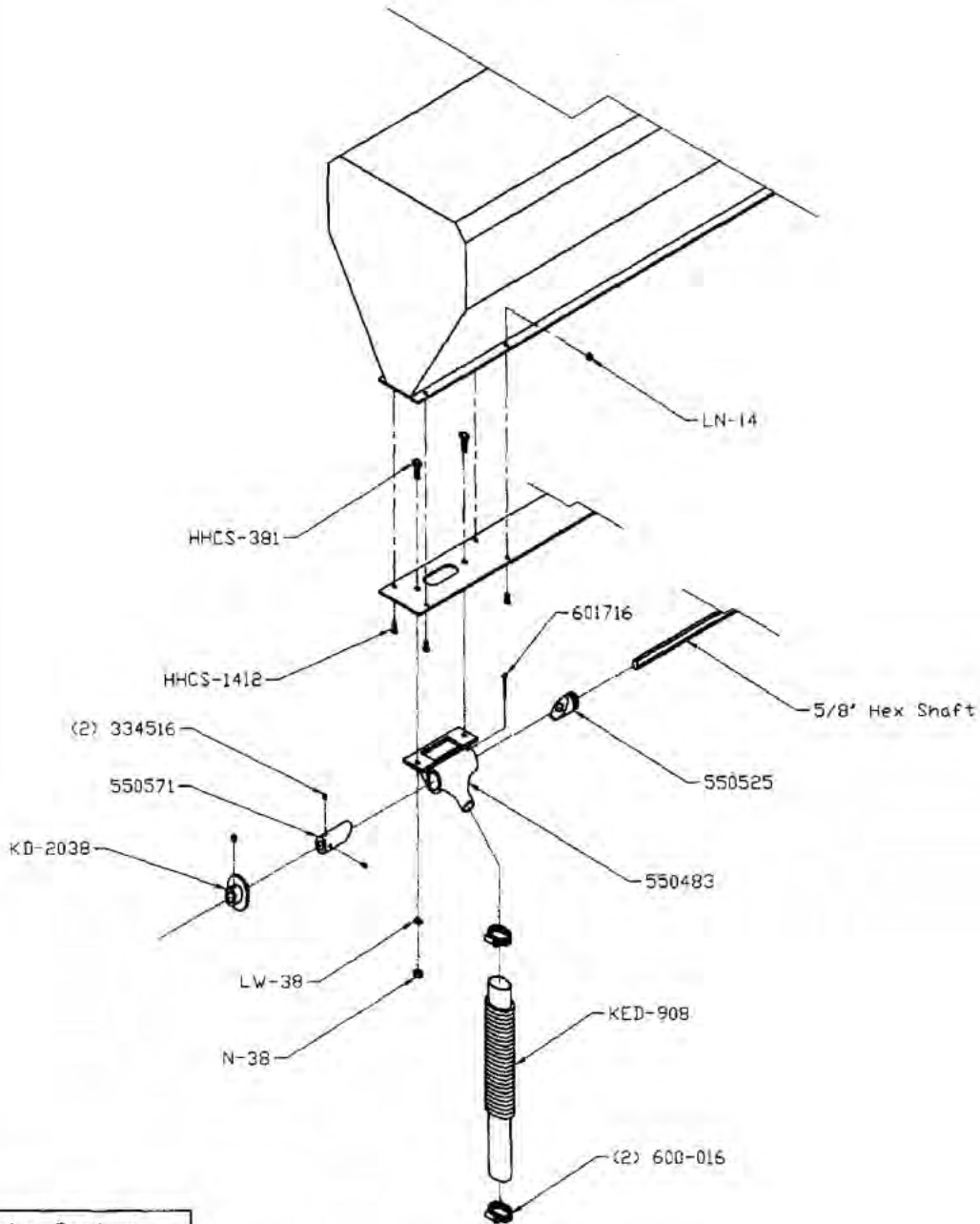

Metering System

Tolerance: +/-

Date: 04/22/05

Rev.# 1

KASCO
SHELBYVILLE, INDIANA

MFG.
CO.
INC.

Scale: 1-1

User: JH

SEED CHART - ECO DRILL

Crop	Seeding Rate	Gear	Seed Drop
	lbs/ acre	Setting	Setting
Alfalfa	15-20	center	1/8"
Bermuda Grass, Common	10-20	center	1/16"
Birdsfoot Trefoil	8-10	Left	3/32"
Blue Grass	60-100	left	5/8"
Buckwheat	45-60	center	1/2"
Clover, Red	8-12	Left	1/8"
Clover, Sweet	10-13	Left	1/8"
Illinois Bundleflower	2-3	Left	1/16"
Millet, Brown Top	30-50	center	3/8"
Milo (grain sorghum)	10-25	Left	1/4"
Oats	65-95	right	5/8"
Orchardgrass	10-12	center	1/4"
Partridge Peas	10-15	center	1/8"
Peas, Austrian Winter	90-120	right	5/8"
Rye Grass	80-110	center	9/16"
Rye, Grain	80-110	center	9/16"
Switchgrass	8-14	left	1/8"
Timothy	8-12	center	1/8"
Turf Grass Mix	60-100	left	5/8"
Turnips	3-4	left	3/32"
Wheat	120-180	center	11/16"
Crop	Seeding Rate	Gear	Seed Drop
	Spacing	Setting	Setting
Corn	6" - 7"	right	1/2"
Soybeans	3" - 4"	right	9/16"
Sunflowers	4" - 5"	left	7/16"

NOTE: This seeding chart is to be used as a guide only. Desired seeding rate (pounds/acre) may vary according to application and geographic location.

NOTE: Recommended seeding rate is for pure stand; rates will be reduced in seed mixes.

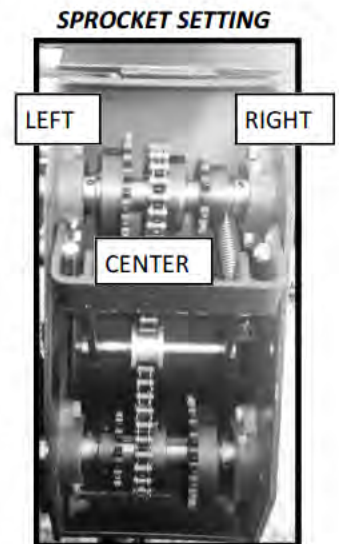

DEPTH CONTROL

TO SET DEPTH OF COULTERS AND OPENERS

- 1) Lower 3pt arms to lowest position.
- 2) Adjust Top Link until desired depth is reached.

NOTES:

- 1) Cultipacker wheels must always be touching the ground.
- 2) Shortening the top link increases depth while Lengthening the top link decreases depth.

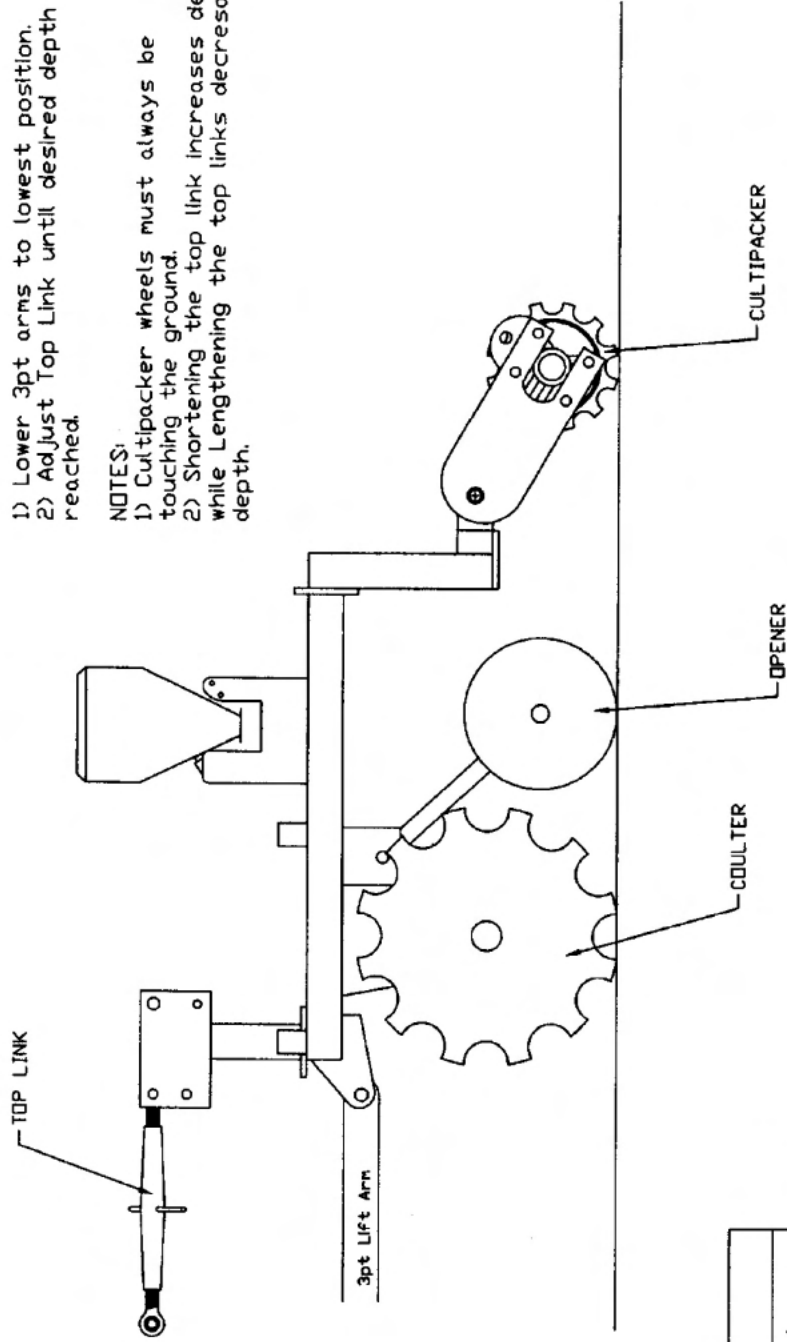

Part #	Rev. #
Manufacturer +/-	Scale:
ASCO MFG. CO. INC.	User:
SHELBYVILLE, IN.	